

MasterCut

Tool Corp.

*The Cutting Edge **M**astered*



English - 中文



INTERNATIONAL PRODUCT CATALOG
ENDMILLS • DRILLS • BURS

国际产品目录
标准立铣刀 • 硬质合金钻头 • 旋转文件

1985	Incorporated in Safety Harbor, FL	成立于佛罗里达州安全港
1986	Form grinding and brazing operations are added	增加了成形磨削和钎焊操作
1989	Company builds its first machine for manufacturing burs	公司制造了第一台制造钻头的机器
1989	First CNC machine is purchased to help with quality and growth	购买第一台CNC机器是为了帮助提高质量和增长
1991	Production of endmills commences	开始生产立铣刀
1994	5 and 6 axis CNC machines purchased for volume production of burs, endmills and drills	购买5轴和6轴数控机床, 用于批量生产钻头, 立铣刀和钻头
1995	Laser marking introduced; laser inspection systems implemented	引入激光打标; 实施激光检测系统
1999	Cell concept introduced in a new facility for greater production and quality control	细胞概念在新设施中引入, 以实现更大的生产和质量控制
2002	Production of spiral router bits, drills, and reamers commences	开始生产螺旋路由器钻头, 钻头和铰刀
2003	ISO 9001:2000 certification achieved; first coating machine purchased	取得ISO 9001: 2000认证; 第一台涂布机购买
2004	MAP, Mastercut's Automated Production system developed	MAP, Mastercut的自动化生产系统开发完成
2005	CNC1st team (Customers' Needs Come 1st) implemented; second coating machine added	CNC1st团队 (客户需求第一) 实施; 第二台涂布机加入
2006	Production begins on high-performance endmills, drills, and miniature tooling	生产始于高性能立铣刀, 钻头和微型刀具
2009	ISO 9001:2008 certification achieved	取得ISO 9001: 2008认证
2011	New surface treatments introduced	引入了新的表面处理
2013	Nano coatings and PRO+ performance tools introduced	推出纳米涂料和超高性能工具
2015	Mastercut celebrates 30th anniversary, and facility expansion	Mastercut庆祝成立30周年, 并扩大设施
2016	Warehouse expansions in USA and Europe	在美国和欧洲的仓库扩建
2018	ISO 9001:2015 certification achieved	取得ISO 9001: 2015认证
2020	Mastercut celebrates 35 years of quality and innovation	Mastercut 庆祝 35 年的质量和创新

Today

Mastercut Tool Corp. celebrates more than 3 decades as a world class carbide cutting tool manufacturer. From inception to the present, our goal is providing the highest quality products and services to our customers. All products are still manufactured in Florida, using state of the art equipment, skilled craftspersons and our exclusive MAP technology.

Our Thanks to Our Loyal Customers and Associates

Our history would not be possible without the support of all those associated with us. We thank all of our customers and associates, as well as our community, for your dedication and loyalty. We pledge to continuously improve for you!

今日辉煌

刀具制造商地位。从建立之初至今, 我们的目标就是向客户提供最优的产品和服务。所有产品都是在位于美国佛罗里达州的制造基地, 采用我们独有的 MAP 技术和最先进的制造设备和技术生产打造

衷心感谢我们忠诚的客户和合作伙伴

没有所有合作伙伴的支持, 就没有我们的今天。感谢所有客户和合作伙伴, 以及我们的团体, 谢谢你们的敬业与忠诚。我们一定会不断改进, 以回馈大家的厚爱!

TABLE OF CONTENTS - 目录

About Mastercut: Our History
我们的历史 2







STANDARD ENDMILLS - 标准立铣刀 (Page 12)		Cermet	Hardened H	Cast Iron K	Titanium S	Non-Ferrous N	Stainless M	Steel P
	Square Endmills 平底铣刀16	Cermet		Cast Iron K	Titanium S	Non-Ferrous N	Stainless M	Steel P
	Ball Endmills 球头立铣刀19	Cermet		Cast Iron K	Titanium S	Non-Ferrous N	Stainless M	Steel P
	Corner Radius Endmills 倒R角铣刀22	Cermet		Cast Iron K	Titanium S	Non-Ferrous N	Stainless M	Steel P
	50° Corner Radius Endmills 50°刃倒R角铣刀24	Cermet		Cast Iron K	Titanium S	Non-Ferrous N	Stainless M	Steel P
	6 Flute Square Endmills 6刃平底铣刀26			Cast Iron K	Titanium S		Stainless M	Steel P
	Square End Double End Endmills 双端平底铣刀27	Cermet		Cast Iron K	Titanium S	Non-Ferrous N	Stainless M	Steel P
	Ball End Double End Endmills 双端球头铣刀28	Cermet		Cast Iron K	Titanium S	Non-Ferrous N	Stainless M	Steel P
	90° Drill Mills 90°钻铣刀29	Cermet		Cast Iron K	Titanium S	Non-Ferrous N	Stainless M	Steel P
	Square End, Straight Flute Endmills 平底直刃铣刀30		Hardened H	Cast Iron K				Steel P
	Ball End, Straight Flute Endmills 球头直刃铣刀31		Hardened H	Cast Iron K				Steel P
	Square End Mini Mills 平底微铣刀32	Cermet		Cast Iron K	Titanium S	Non-Ferrous N	Stainless M	Steel P
	Ball End Mini Mills 球头微铣刀33	Cermet		Cast Iron K	Titanium S	Non-Ferrous N	Stainless M	Steel P
	Short Flute Square Endmills 短刃平底铣刀34	Cermet		Cast Iron K	Titanium S	Non-Ferrous N	Stainless M	Steel P
	Short Flute Ball Endmills 短刃球头铣刀35	Cermet		Cast Iron K	Titanium S	Non-Ferrous N	Stainless M	Steel P
	Short Flute Reduced Shank Square Endmills 短刃平底铣刀缩径刀杆36	Cermet		Cast Iron K	Titanium S	Non-Ferrous N	Stainless M	Steel P

TABLE OF CONTENTS - 目录















		Cermet	Hardened	Cast Iron	Titanium	Non-Ferrous	Stainless	Steel
		H	K	S	N	M	P	
	Short Flute Reduced Shank Ball Endmills 短刃球头端铣刀 缩径刀杆37	Cermet		Cast Iron K	Titanium S	Non-Ferrous N	Stainless M	Steel P
	Short Flute Necked Square Endmills 短刃缩颈平底铣刀38	Cermet		Cast Iron K	Titanium S	Non-Ferrous N	Stainless M	Steel P
	Short Flute Necked Ball Endmills 短刃缩颈球头端铣刀39	Cermet		Cast Iron K	Titanium S	Non-Ferrous N	Stainless M	Steel P
	Short Flute Necked Corner Radius Endmills 短刃缩径缩颈倒R角铣刀40	Cermet		Cast Iron K	Titanium S	Non-Ferrous N	Stainless M	Steel P
	Extra Long Square Endmills 超长2刃 平底铣刀42	Cermet		Cast Iron K	Titanium S	Non-Ferrous N	Stainless M	Steel P
	Extra Length Ball Endmills 超长2刃球头铣刀43	Cermet		Cast Iron K	Titanium S	Non-Ferrous N	Stainless M	Steel P
HIGH PERFORMANCE ENDMILLS - 高性能立铣刀 (Page 44)								
	V4, V5, HY5 Tool Features V4, V5, HY5刀具特征48	Cermet	Hardened H	Cast Iron K	Titanium S		Stainless M	Steel P
	F45, AxMill, HyperMill and AlumaZip Tool Features AxMill和Alumazip刀具特征49	Cermet	Hardened H	Cast Iron K	Titanium S		Stainless M	Steel P
	V4 Square Endmills V4平底铣刀50	Cermet	Hardened H	Cast Iron K	Titanium S		Stainless M	Steel P
	V4 Ball Endmills V4球头铣刀52	Cermet	Hardened H	Cast Iron K	Titanium S		Stainless M	Steel P
	V4 Corner Radius Endmills V4倒R角刀铣刀54	Cermet	Hardened H	Cast Iron K	Titanium S		Stainless M	Steel P
	V5 Square Endmills V5平底铣刀61	Cermet	Hardened H	Cast Iron K	Titanium S		Stainless M	Steel P
	V5 Ball Endmills V5球头铣刀62	Cermet	Hardened H	Cast Iron K	Titanium S		Stainless M	Steel P
	V5 Corner Radius Endmills V5 倒R角铣刀63	Cermet	Hardened H	Cast Iron K	Titanium S		Stainless M	Steel P
	HY5 Square Endmills HY5 平底铣刀64	Cermet	Hardened H	Cast Iron K	Titanium S		Stainless M	Steel P

TABLE OF CONTENTS - 目录

















		Cermet	Hardened	Cast Iron	Titanium	Non-Ferrous	Stainless	Steel
		C	H	K	S	N	M	P
	HY5 Corner Radius Endmills HY5 倒R角铣刀 65	C	H	K	S		M	P
	F45 6FL Square Endmills F45, 6刃平底铣刀 70	C	H	K	S		M	P
	F45 6FL Corner Radius Endmills F45, 6刃倒R角铣刀 71	C	H	K	S		M	P
	Ball Necked Mold Mills 球头缩颈模具铣刀. 72	C	H	K	S		M	P
	Ball Necked Extended Reach Mold Mills 加长缩颈系列 72	C	H	K	S		M	P
	3FL 60° Helix Twister Mills 3刃 60°螺旋刃铣刀 73				S		M	P
	Roughers - Coarse Pitch 梳齿粗铣刀-粗牙 74	C	H	K	S	N	M	P
	Roughers - Fine Pitch 梳齿粗铣刀-细牙 75	C	H	K	S	N	M	P
	Roughers - Medium Pitch 梳齿粗铣刀-中牙 76	C	H	K	S	N	M	P
	AxMills - Square End 铝合金专用Axmill平底铣刀 77					N		
	AxMills - Corner Radius 铝合金专用Axmill倒R角铣刀 78					N		
	AxMills - Square End Chipbreaker 带碎屑刃Axmill 平底铣刀 79					N		
	AxMills - Corner Radius Chipbreaker 带碎屑刃Axmill倒R角铣刀 80					N		
	45° HyperMills 45°螺旋刃平底铝合金刀. 81					N		
	55° AlumaZips 55°螺旋刃平底铝合金铣刀 81					N		

TABLE OF CONTENTS - 目录







PRO+ PERFORMANCE ENDMILLS - 超性能立铣刀 (Page 82)

	V4 Pro+ Square Endmills V4 超平底铣刀84
	V4 Pro+ Ball Endmills V4 超球头铣刀86
	V4 Pro+ Corner Radius Endmills V4 超倒R角刀铣刀88
	V5 Pro+ Square Endmills V5 超平底铣刀93
	V5 Pro+ Ball Endmills V5 超球头铣刀94
	V5 Pro+ Corner Radius Endmills V5 超倒R角铣刀95
	HY5 Pro+ Square Endmills HY5 超平底铣刀96
	HY5 Pro+ Corner Radius Endmills HY5 超倒R角铣刀97
	F45 Pro+ Square Endmills F45, 超6刃平底铣刀	102
	F45 Pro+ Corner Radius Endmills F45, 超6刃倒R角铣刀	103
	V7 Pro+ Endmills V7, 超	103

Cermet	Hardened	Cast Iron	Titanium	Non-Ferrous	Stainless	Steel
	H	K	S	N	M	P

Cermet	Hardened	Cast Iron	Titanium	Non-Ferrous	Stainless	Steel
	H	K	S	N	M	P





CARBIDE DRILLS, COUNTERSINKS - 硬质合金钻头, 沉孔钻 (Page 104)

	2 Flute Jobber Drills 2刃118°四面尖 标准钻头	107
	3 Flute Jobber Drills 3刃130°高性能钻尖	108
	Stub Drills 短钻头	110
	Medium Length Drills 中长钻头	111
	Spade Drills 扁铲钻头	113
	NC Spotting Drills NC 定位钻	114
	Drill and Countersink / Center Drills 中心沉孔钻	115

Cermet	Hardened	Cast Iron	Titanium	Non-Ferrous	Stainless	Steel
	H	K	S	N	M	P

Cermet	Hardened	Cast Iron	Titanium	Non-Ferrous	Stainless	Steel
	H	K	S	N	M	P

TABLE OF CONTENTS - 目录

		Cermet	H	K	S	N	M	P
	Countersinks, 1 Flute 沉孔钻 单刀			Cast Iron K	Titanium S	Non-Ferrous N	Stainless M	Steel P
	Countersinks, 3 Flute 沉孔钻 三刀片			Cast Iron K	Titanium S	Non-Ferrous N	Stainless M	Steel P
	Countersinks, 6 Flute 沉孔钻 六刀片			Cast Iron K	Titanium S	Non-Ferrous N	Stainless M	Steel P
	Chamfer Tools 倒角刀	H	Cast Iron K	Titanium S	Non-Ferrous N	Stainless M	Steel P	

HIGH PERFORMANCE DRILLS - 高性能钻头 (Page 120)

		Cermet	H	K	S	N	M	P
	Hurricane Drill High Performance Features 飓风高性能钻的特点							
	Hurricane 3xD Non-Coolant Through & Coolant Through 3x倍径实心和中通冷却钻头	H	Cast Iron K	Titanium S	Non-Ferrous N	Stainless M	Steel P	
	Hurricane 5xD Non-Coolant Through & Coolant Through 5x倍径实心和中通冷却钻头	H	Cast Iron K	Titanium S	Non-Ferrous N	Stainless M	Steel P	
	Hurricane 8xD Coolant Through 8x倍径实心和中通冷却钻头	H	Cast Iron K	Titanium S	Non-Ferrous N	Stainless M	Steel P	

BURS - 旋转文件 (Page 136)

















		Cermet	H	K	S	N	M	P
	SA Burs - Cylindrical Shape without End Cut SA-园柱型,无端切旋转锉		H	Cast Iron K	Titanium S		Stainless M	Steel P
	SB Burs - Cylindrical Shape with End Cut SB-园柱型,带端切旋转锉		H	Cast Iron K	Titanium S		Stainless M	Steel P
	SC Burs - Radius Cylindrical Shape SC-球头柱体型旋转锉		H	Cast Iron K	Titanium S		Stainless M	Steel P
	SD Burs - Ball Shape SD-球体型旋转锉		H	Cast Iron K	Titanium S		Stainless M	Steel P
	SE Burs - Oval Shape SE-橄榄型旋转锉		H	Cast Iron K	Titanium S		Stainless M	Steel P
	SF Burs - Radius Tree Shape SF-圆顶树体型旋转锉		H	Cast Iron K	Titanium S		Stainless M	Steel P
	SG Burs - Pointed Tree Shape SG-尖顶树体型旋转锉		H	Cast Iron K	Titanium S		Stainless M	Steel P

TABLE OF CONTENTS - 目录

	Cermet	Hardened	Cast Iron	Titanium	Non-Ferrous	Stainless	Steel
	H	K	S	N	M	P	
 SH Burs - Flame Shape SH-火焰型旋转锉 146	H	K	S		M	P	
 SJ Burs - 60° Included Cone Shape SJ-60°锥体型旋转锉 147	H	K	S		M	P	
 SK Burs - 90° Included Cone Shape SK-90°锥体型旋转锉 147	H	K	S		M	P	
 SL Burs - Radius Cone Shape SL-圆顶锥体型旋转锉 148	H	K	S		M	P	
 SM Burs - Pointed Cone Shape SM-尖顶锥体型旋转锉 149	H	K	S		M	P	
 SN Burs - Inverted Cone Shape SN-倒锥体型旋转锉 150	H	K	S		M	P	

BURS - ROUTERS AND SPECIAL APPLICATION 旋转文件 - 路由器和特殊应用

 Fiberglass Routers 玻璃纤维专用锉铣刀 151	N/A						
 Diemills Diemills 152	H	K	S		M	P	
 Piloted Diemills Piloted Diemills 153	H	K	S		M	P	
 Tire Burs 轮胎修理旋转文件 154	N/A						

BUR SETS - 旋转文件集



 Plastic Pouch Bur Sets 塑料袋装旋转锉组件 154	H	K	S		M	P
 12 Piece Plastic Box Bur Sets 塑料盒装旋转锉组件 155	H	K	S		M	P
 24 Piece Countertop Displays 24件套装展示盒 155	H	K	S		M	P

TABLE OF CONTENTS - 目录







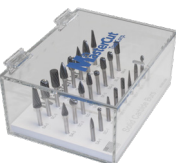











FRACTIONAL PRODUCTS - 具有英寸测量的产品 (Page 156)		Cermet	Hardened	Cast Iron	Titanium	Non-Ferrous	Stainless	Steel
		H	K	S	N	M	P	
	Fractional Square Endmills 平底铣刀 160	Cermet		K	S	N	M	P
	Fractional Ball Endmills 球头铣刀 161	Cermet		K	S	N	M	P
	Fractional Corner Radius Endmills 倒R角立铣刀 162	Cermet		K	S	N	M	P
	Fractional 90° Drill Mills 90°钻铣刀 163	Cermet		K	S	N	M	P
	Fractional Square End Mini Mills 平底微铣刀 164	Cermet		K	S	N	M	P
	Fractional Ball End Mini Mills 球头微铣刀 165	Cermet		K	S	N	M	P
	Fractional V4 Square Endmills V4平底铣刀 166	Cermet	H	K	S		M	P
	Fractional V4 Ball Endmills V4球头铣刀 167	Cermet	H	K	S		M	P
	Fractional V4 Corner Radius Endmills V4倒R角刀铣刀 168	Cermet	H	K	S		M	P
	Fractional V5 Square Endmills V5平底铣刀 169	Cermet	H	K	S		M	P
	Fractional V5 Ball Endmills V5球头铣刀 170	Cermet	H	K	S		M	P
	Fractional V5 Corner Radius Endmills V5 倒R角铣刀 171	Cermet	H	K	S		M	P
	Fractional F45 6 Flute Square Endmills F45,6刃平底铣刀 172	Cermet	H	K	S		M	P
	Fractional F45 6 Flute Corner Radius Endmills F45, 6刃倒R角铣刀 173	Cermet	H	K	S		M	P
	Fractional Square End AxMills 铝合金专用Axmill平底铣刀 174					N		
	Fractional Jobber Drills 2刃标准钻头 175	Cermet	H	K	S	N	M	P
	Fractional Spade Drills 扁铲钻 178	Cermet	H	K	S	N	M	P
	Fractional NC Spotting Drills NC 定位钻 179	Cermet	H	K	S	N	M	P

TABLE OF CONTENTS - 目录













		Cermet	Hardened	Cast Iron	Titanium	Non-Ferrous	Stainless	Steel
		H	K	S	N	M	P	
	Fractional Drill and Countersink/Centerdrill 中心钻和沉孔钻 180	H	K	S	N	M	P	
	Fractional SA Bur - Cylindrical Shape without End Cut SA-园柱型,无端切旋转锉. 181	H	K		N	M	P	
	Fractional SB Bur - Cylindrical with Endcut SB-园柱型,带端切旋转锉 182	H	K		N	M	P	
	Fractional SC Bur - Radius Cylindrical Shape SC-球头柱体型旋转锉. 183	H	K		N	M	P	
	Fractional SD Bur - Ball Shape SD-球体型旋转锉 184	H	K		N	M	P	
	Fractional SE Bur - Oval Shape SE-橄榄型旋转锉. 185	H	K		N	M	P	
	Fractional SF Bur - Radius Tree Shape SF-圆顶树体型旋转锉 186	H	K		N	M	P	
	Fractional SG Bur - Pointed Tree Shape SG-尖顶树体型旋转锉 187	H	K		N	M	P	
	Fractional SH Bur - Flame Shape SH-尖顶树体型旋转锉 187	H	K		N	M	P	
	Fractional SL Bur - Radius Cone Shape SL-圆顶锥体型旋转锉 188	H	K		N	M	P	
	Fractional SM Bur - Pointed Cone Shape SM-尖顶锥体型旋转锉. 189	H	K		N	M	P	

TABLE OF CONTENTS - 目录

COATINGS - 涂层 (Page 190)



Mastercut Coating Options

可供选择的涂层 190

Available Coatings 191

可供选择的涂层 193

TECHNICAL INFORMATION - 技術情報 (Page 194)

Technical Information 195

技術情報 196

Technical Information for AxMills

对于 AxMills 的技术信息 197

Technical Information for HP Drills

对于高性能旋风钻的技术信息 197

Mastercut Troubleshooting Guides

刀具问题解决指南 198

Troubleshooting Guide Solution Keys

可能发生的问题和解决方案 201

Technical Information Materials Groupings

材料分组技术信息 202

Technical Information for Endmills

端铣刀的技术信息 204

Technical Information for HP Endmills

高性能立铣刀的技术信息 206

TERMS AND CONDITIONS - 商务条款 (Page 208)

Terms and Conditions 208

商务条款 208

STANDARD ENDMILLS

标准立铣刀

- **Square End** - 平底铣刀
- **Ball End** - 球头铣刀
- **Corner Radius** - 倒R角铣刀
- **Double End** - 双端铣刀
- **Drill Mills** - 钻铣刀
- **Mini Mills** - 微铣刀



Customers' Needs Come First! This is what truly matters to us. To ensure you the fastest possible service, we have assembled simulation, engineering, production scheduling, and inventory personnel into one unit, wherein they can collaborate on any and all special requests from you, the moment your request is received. They are dedicated and qualified to assist you with solutions, fast!



客户需求第一位原则

客户需求至上！这是我们真正的重中之重。为确保尽可能为您提供极致快捷的服务，我们将模拟、设计、生产调度和库存管理人员集中到一个工作间，他们可在此针对您的任何特殊要求开展合作，即时响应您的要求。他们爱岗敬业、资质过硬，能助力您快速找出解决方案！



LEGENDS

图示说明

Features 产品特点

	2 Flutes 2刃		Multi-Flute 多刃		Ball End 球头铣刀
	3 Flutes 3刃		Plain Shank 普通刀柄		Double End Sq. 双端平底方头铣刀
	4 Flutes 4刃		Corner Radius 倒R角		Double End Ball 双端球头铣刀
	6 Flutes 6刃		Square End 平底铣刀		

Coatings 涂层

	PowerA PowerA (Aluminum Titanium Nitride AlTiN)		Uncoated 无涂层
---	--	---	-----------------

Superior Carbide Blend

迈斯卡的超级硬质合金材质

Mastercut's Superior Carbide Blend – A-Gr-SiV (Active Grain Sized Volume)

Our superior tungsten carbide gives you the ability to be *aggressive* when you need to be. Growth inhibitors in our submicron carbide blanks maintain the most consistent grain size available, giving you superior hardness and toughness.

迈斯卡的超级硬质合金材质 - A-Gr-SiV

迈斯卡的超级硬质合金材质 - 拥有均匀亚微米晶粒，完美的硬度和韧性的结合，保证我们的刀具可以面对各种挑战时游刃有余。

TABLE OF CONTENTS - 目录











































































































































	Square Endmills 平底铣刀16						
	Ball Endmills 球头立铣刀19						
	Corner Radius Endmills 倒R角铣刀22						
	50° Corner Radius Endmills 50°刀倒R角铣刀24						
	6 Flute Square Endmills 6刀平底铣刀26						
	Square End Double End Endmills 双端平底铣刀27						
	Ball End Double End Endmills 双端球头铣刀28						
	90° Drill Mills 90°钻铣刀29						
	Square End, Straight Flute Endmills 平底直刃铣刀30						
	Ball End, Straight Flute Endmills 球头直刃铣刀31						
	Square End Mini Mills 平底微铣刀32						

TABLE OF CONTENTS - 目录

	Ball End Mini Mills 球头微铣刀33		    
	Short Flute Square Endmills 短刃平底铣刀34		    
	Short Flute Ball Endmills 短刃球头铣刀35		    
	Short Flute Reduced Shank Square Endmills 短刃平底铣刀缩径刀杆36		    
	Short Flute Reduced Shank Ball Endmills 短刃球头端铣刀 缩径刀杆37		    
	Short Flute Necked Square Endmills 短刃缩颈平底铣刀38		    
	Short Flute Necked Ball Endmills 短刃缩颈球头端铣刀39		    
	Short Flute Necked Corner Radius Endmills 短刃缩径缩颈倒R角铣刀40		    
	Extra Long Square Endmills 超长2刃 平底铣刀42		    
	Extra Length Ball Endmills 超长2刃球头铣刀43		    

SQUARE ENDMILLS

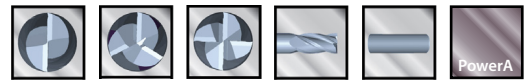

平底铣刀

Standard, Stub and Long	2, 3 and 4 Flutes	Coated and Uncoated
标准,短,长 -长度系列;	2,3 &4刀系列;	涂层和无涂层

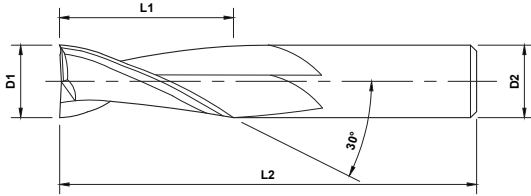

Stub, Series 313



Standard, Series 309,310,311



Long, Series 304

X-Long, Series 315, 317

Length Key (K)

■ Stub
 ■ Standard
 ■ Long
 ■ X-Long

Quick Ship Items



K	OD	LOC	SHK	OAL	Uncoated			PowerA					
					D1	L1	D2	L2	2 Flute	3 Flute	4 Flute	2 Flute	3 Flute
1			3	38	2	3	38	313-102	-	313-702	313-102-1	-	313-702-1
					3	3	38	309-202	310-202	311-202	309-202-1	310-202-1	311-202-1
1.5			3	38	3	3	38	313-104	-	313-704	313-104-1	-	313-704-1
					5	3	38	309-204	310-204	311-204	309-204-1	310-204-1	311-204-1
2			3	38	4	3	38	313-106	-	313-706	313-106-1	-	313-706-1
					6	3	38	309-206	310-206	311-206	309-206-1	310-206-1	311-206-1
2.5			3	38	5	3	38	313-108	-	313-708	313-108-1	-	313-708-1
					7	3	38	309-208	310-208	311-208	309-208-1	310-208-1	311-208-1
3			3	38	6	3	38	313-110	-	313-710	313-110-1	-	313-710-1
					12	3	38	309-210	310-210	311-210	309-210-1	310-210-1	311-210-1
					25	3	65	304-202	-	306-202	304-202-1	-	306-202-1

SQUARE ENDMILLS

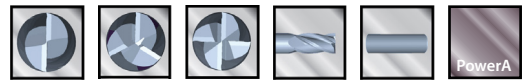

平底铣刀

Length Key (K)

■ Stub
 ■ Standard
 ■ Long
 ■ X-Long

Quick Ship Items



K	OD	LOC	SHK	OAL	Uncoated			PowerA		
					2 Flute	3 Flute	4 Flute	2 Flute	3 Flute	4 Flute
3.5	7	4	50		313-112	-	313-712	313-112-1	-	313-712-1
	12	4	50		309-212	310-212	311-212	309-212-1	310-212-1	311-212-1
4	8	4	50		313-114	-	313-714	313-114-1	-	313-714-1
	14	4	50		309-214	310-214	311-214	309-214-1	310-214-1	311-214-1
	25	4	65		304-204	-	306-204	304-204-1	-	306-204-1
4.5	9	5	50		313-116	-	313-716	313-116-1	-	313-716-1
	14	5	50		309-216	310-216	311-216	309-216-1	310-216-1	311-216-1
5	10	5	50		313-118	-	313-718	313-118-1	-	313-718-1
	16	5	50		309-218	310-218	311-218	309-218-1	310-218-1	311-218-1
	25	5	75		304-206	-	306-206	304-206-1	-	306-206-1
6	12	6	50		313-120	-	313-720	313-120-1	-	313-720-1
	19	6	63		309-220	310-220	311-220	309-220-1	310-220-1	311-220-1
	25	6	75		304-208	-	306-208	304-208-1	-	306-208-1
	38	6	100		315-202	-	317-202	315-202-1	-	317-202-1
	75	6	150		315-204	-	317-204	315-204-1	-	317-204-1
	75	6	200		315-206	-	317-206	315-206-1	-	317-206-1
	75	8	200		315-208	-	317-208	315-208-1	-	317-208-1
7	19	8	63		309-222	310-222	311-222	309-222-1	310-222-1	311-222-1
8	12	8	50		313-122	-	313-722	313-122-1	-	313-722-1
	19	8	63		309-224	310-224	311-224	309-224-1	310-224-1	311-224-1
	25	8	75		304-210	-	306-210	304-210-1	-	306-210-1
	42	8	100		315-210	-	317-210	315-210-1	-	317-210-1
	75	8	150		315-212	-	317-212	315-212-1	-	317-212-1
	75	8	200		315-214	-	317-214	315-214-1	-	317-214-1
	75	10	200		315-216	-	317-216	315-216-1	-	317-216-1
9	22	10	70		309-226	310-226	311-226	309-226-1	310-226-1	311-226-1
10	14	10	50		313-124	-	313-724	313-124-1	-	313-724-1
	22	10	70		309-228	310-228	311-228	309-228-1	310-228-1	311-228-1
	38	10	100		304-212	-	306-212	304-212-1	-	306-212-1
	75	10	150		315-218	-	317-218	315-218-1	-	317-218-1
	75	10	200		315-220	-	317-220	315-220-1	-	317-220-1
11	25	11	70		309-230	310-230	311-230	309-230-1	310-230-1	311-230-1

SQUARE ENDMILLS

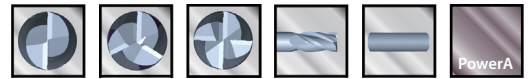

平底铣刀



Length Key (K)

Stub
 Standard
 Long
 X-Long

Quick Ship Items



K	OD	LOC	SHK	OAL	Uncoated			PowerA																													
					D1	L1	D2	L2	2 Flute	3 Flute	4 Flute	2 Flute	3 Flute	4 Flute																							
12	12	16	12	63	313-126	-	313-726	313-126-1	-	313-726-1																											
											25	12	75	309-232	310-232	311-232	309-232-1	310-232-1	311-232-1																		
																				50	12	100	304-214	-	306-214	304-214-1	-	306-214-1									
																													75	12	150	315-222	-	317-222	315-222-1	-	317-222-1
14	14	30	14	88	309-234	310-234	311-234	309-234-1	310-234-1	311-234-1																											
											56	14	125	304-216	-	306-216	304-216-1	-	306-216-1																		
																				62	14	125	315-226	-	317-226	315-226-1	-	317-226-1									
																													75	14	150	315-228	-	317-228	315-228-1	-	317-228-1
16	16	20	16	75	313-128	-	313-728	313-128-1	-	313-728-1																											
											32	16	88	309-236	310-236	311-236	309-236-1	310-236-1	311-236-1																		
																				75	16	150	304-218	-	306-218	304-218-1	-	306-218-1									
																													75	16	200	315-232	-	317-232	315-232-1	-	317-232-1
18	18	36	18	100	309-238	310-238	311-238	309-238-1	310-238-1	311-238-1																											
											75	18	150	304-220	-	306-220	304-220-1	-	306-220-1																		
																				75	18	200	315-234	-	317-234	315-234-1	-	317-234-1									
20	20	38	20	100	309-240	310-240	311-240	309-240-1	310-240-1	311-240-1																											
											75	20	150	304-222	-	306-222	304-222-1	-	306-222-1																		
																				75	20	200	315-236	-	317-236	315-236-1	-	317-236-1									
22	22	38	22	100	309-242	310-242	311-242	309-242-1	310-242-1	311-242-1																											
											25	25	100	309-244	310-244	311-244	309-244-1	310-244-1	311-244-1																		
75	25	150	304-224	-	306-224	304-224-1	-	306-224-1																													

BALL ENDMILLS

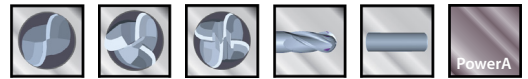

球头立铣刀

Standard, Stub and Long	2, 3 and 4 Flutes	Coated and Uncoated
标准,短,长 -长度系列;	2,3 &4刃系列;	涂层和无涂层

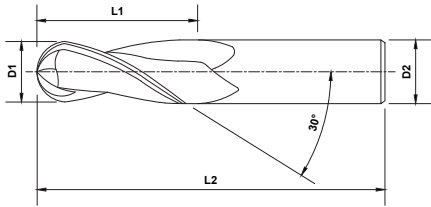

Stub, Series 313



Standard, Series 309,310,311



Long, Series 304

X-Long, Series 315, 317

Length Key (K)

■ Stub
 ■ Standard
 ■ Long
 ■ X-Long

Quick Ship Items



K	OD	LOC	SHK	OAL	Uncoated			PowerA		
					2 Flute	3 Flute	4 Flute	2 Flute	3 Flute	4 Flute
1	D1	L1	D2	L2	313-002	-	313-602	313-002-1	-	313-602-1
					309-002	310-002	311-002	309-002-1	310-002-1	311-002-1
1.5					313-004	-	313-604	313-004-1	-	313-604-1
					309-004	310-004	311-004	309-004-1	310-004-1	311-004-1
2					313-006	-	313-606	313-006-1	-	313-606-1
					309-006	310-006	311-006	309-006-1	310-006-1	311-006-1
2.5					313-008	-	313-608	313-008-1	-	313-608-1
					309-008	310-008	311-008	309-008-1	310-008-1	311-008-1
3					313-010	-	313-610	313-010-1	-	313-610-1
					309-010	310-010	311-010	309-010-1	310-010-1	311-010-1
					304-002	-	306-002	304-002-1	-	306-002-1

BALL ENDMILLS

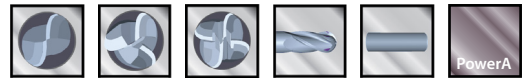

球头立铣刀

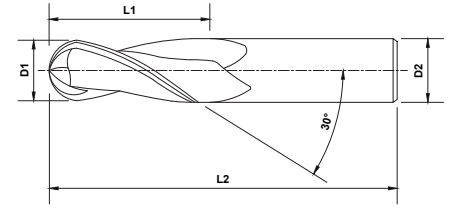

Length Key (K)

Stub
 Standard
 Long
 X-Long

Quick Ship Items



K	OD	LOC	SHK	OAL	Uncoated			PowerA		
					2 Flute	3 Flute	4 Flute	2 Flute	3 Flute	4 Flute
3.5	7	4	50	313-012	-	313-612	313-012-1	-	313-612-1	
	12	4	50	309-012	310-012	311-012	309-012-1	310-012-1	311-012-1	
4	8	4	50	313-014	-	313-614	313-014-1	-	313-614-1	
	14	4	50	309-014	310-014	311-014	309-014-1	310-014-1	311-014-1	
	25	4	65	304-004	-	306-004	304-004-1	-	306-004-1	
4.5	9	5	50	313-016	-	313-616	313-016-1	-	313-616-1	
	14	5	50	309-016	310-016	311-016	309-016-1	310-016-1	311-016-1	
5	10	5	50	313-018	-	313-618	313-018-1	-	313-618-1	
	16	5	50	309-018	310-018	311-018	309-018-1	310-018-1	311-018-1	
	25	5	75	304-006	-	306-006	304-006-1	-	306-006-1	
6	12	6	50	313-020	-	313-620	313-020-1	-	313-620-1	
	19	6	63	309-020	310-020	311-020	309-020-1	310-020-1	311-020-1	
	25	6	75	304-008	-	306-008	304-008-1	-	306-008-1	
	38	6	100	315-002	-	317-002	315-002-1	-	317-002-1	
	75	6	150	315-004	-	317-004	315-004-1	-	317-004-1	
	75	6	200	315-006	-	317-006	315-006-1	-	317-006-1	
	75	8	200	315-008	-	317-008	315-008-1	-	317-008-1	
7	19	8	63	309-022	310-022	311-022	309-022-1	310-022-1	311-022-1	
8	12	8	50	313-022	-	313-622	313-022-1	-	313-622-1	
	19	8	63	309-024	310-024	311-024	309-024-1	310-024-1	311-024-1	
	25	8	75	304-010	-	306-010	304-010-1	-	306-010-1	
	42	8	100	315-010	-	317-010	315-010-1	-	317-010-1	
	75	8	150	315-012	-	317-012	315-012-1	-	317-012-1	
	75	8	200	315-014	-	317-014	315-014-1	-	317-014-1	
9	22	10	70	309-026	310-026	311-026	309-026-1	310-026-1	311-026-1	
	14	10	50	313-024	-	313-624	313-024-1	-	313-624-1	
	22	10	70	309-028	310-028	311-028	309-028-1	310-028-1	311-028-1	
	38	10	100	304-012	-	306-012	304-012-1	-	306-012-1	
	75	10	150	315-018	-	317-018	315-018-1	-	317-018-1	
10	75	10	200	315-020	-	317-020	315-020-1	-	317-020-1	

BALL ENDMILLS

球头立铣刀

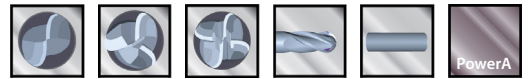

ENDMILLS

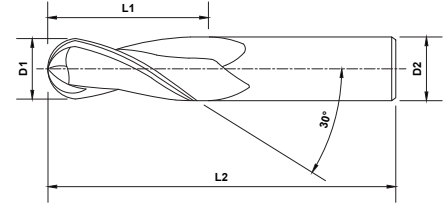

Length Key (K)



Quick Ship Items



K	OD D1	LOC L1	SHK D2	OAL L2	Uncoated			PowerA		
					2 Flute	3 Flute	4 Flute	2 Flute	3 Flute	4 Flute
11	25	11	70	309-030	310-030	311-030	309-030-1	310-030-1	311-030-1	
	16	12	63	313-026	-	313-626	313-026-1	-	313-626-1	
	25	12	75	309-032	310-032	311-032	309-032-1	310-032-1	311-032-1	
12	50	12	100	304-014	-	306-014	304-014-1	-	306-014-1	
	75	12	150	315-022	-	317-022	315-022-1	-	317-022-1	
	75	12	200	315-024	-	317-024	315-024-1	-	317-024-1	
14	30	14	88	309-034	310-034	311-034	309-034-1	310-034-1	311-034-1	
	56	14	125	304-016	-	306-016	304-016-1	-	306-016-1	
	62	14	125	315-026	-	317-026	315-026-1	-	317-026-1	
	75	14	150	315-028	-	317-028	315-028-1	-	317-028-1	
	75	16	200	315-030	-	317-030	315-030-1	-	317-030-1	
16	20	16	75	313-028	-	313-628	313-028-1	-	313-628-1	
	32	16	88	309-036	310-036	311-036	309-036-1	310-036-1	311-036-1	
	75	16	150	304-018	-	306-018	304-018-1	-	306-018-1	
	75	16	200	315-032	-	317-032	315-032-1	-	317-032-1	
18	36	18	100	309-038	310-038	311-038	309-038-1	310-038-1	311-038-1	
	75	18	150	304-020	-	306-020	304-020-1	-	306-020-1	
	75	18	200	315-034	-	317-034	315-034-1	-	317-034-1	
20	38	20	100	309-040	310-040	311-040	309-040-1	310-040-1	311-040-1	
	75	20	150	304-022	-	306-022	304-022-1	-	306-022-1	
	75	20	200	315-036	-	317-036	315-036-1	-	317-036-1	
22	38	22	100	309-042	310-042	311-042	309-042-1	310-042-1	311-042-1	
	38	25	100	309-044	310-044	311-044	309-044-1	310-044-1	311-044-1	
25	38	25	100	309-044	310-044	311-044	309-044-1	310-044-1	311-044-1	
	75	25	150	304-024	-	306-024	304-024-1	-	306-024-1	

CORNER RADIUS ENDMILLS



倒R角铣刀

2 and 4 Flutes	Coated and Uncoated
2和4刃	涂层和无涂层

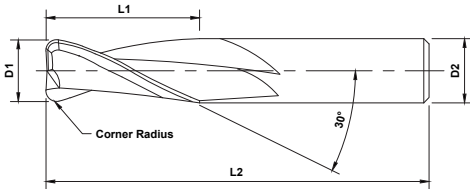

Stub, Series 309,311



Standard, Series 309,311



Long, Series 309,311

Length Key (K)

■ Stub
 ■ Standard
 ■ Long

Quick Ship Items



K	OD	LOC	SHK	OAL	Radius	Uncoated		PowerA	
						2 Flute	4 Flute	2 Flute	4 Flute
	D1	L1	D2	L2	R				
2	6	3	38	0.50	309-401	311-401	309-401-1	311-401-1	
	12	3	38	0.50	309-411	311-411	309-411-1	311-411-1	
4	14	4	50	0.25	309-420	311-420	309-420-1	311-420-1	
	14	4	50	0.50	309-421	311-421	309-421-1	311-421-1	
	14	4	50	0.75	309-422	311-422	309-422-1	311-422-1	
	14	4	50	1.00	309-423	311-423	309-423-1	311-423-1	
5	16	5	50	0.50	309-431	311-431	309-431-1	311-431-1	
6	19	6	63	0.25	309-440	311-440	309-440-1	311-440-1	
	19	6	63	0.50	309-441	311-441	309-441-1	311-441-1	
	19	6	63	0.75	309-442	311-442	309-442-1	311-442-1	
	19	6	63	1.00	309-443	311-443	309-443-1	311-443-1	
	19	6	63	1.25	309-444	311-444	309-444-1	311-444-1	
	19	6	63	1.50	309-445	311-445	309-445-1	311-445-1	
8	19	8	63	0.25	309-450	311-450	309-450-1	311-450-1	
	19	8	63	0.50	309-451	311-451	309-451-1	311-451-1	
	19	8	63	0.75	309-452	311-452	309-452-1	311-452-1	
	19	8	63	1.00	309-453	311-453	309-453-1	311-453-1	
	19	8	63	1.25	309-454	311-454	309-454-1	311-454-1	
	19	8	63	1.50	309-455	311-455	309-455-1	311-455-1	
	19	8	63	2.00	309-456	311-456	309-456-1	311-456-1	

CORNER RADIUS ENDMILLS



倒R角铣刀

Corner radius for extra strength and precision
 刀尖圆角有力于实现更高强度和精度



Length Key (K)
 Stub Standard Long

Quick Ship Items



K	OD	LOC	SHK	OAL	Radius	Uncoated		PowerA	
						2 Flute	4 Flute	2 Flute	4 Flute
10	25	10	70	0.25	309-460	311-460	309-460-1	311-460-1	
				0.50	309-461	311-461	309-461-1	311-461-1	
				0.75	309-462	311-462	309-462-1	311-462-1	
				1.00	309-463	311-463	309-463-1	311-463-1	
				1.25	309-464	311-464	309-464-1	311-464-1	
				1.50	309-465	311-465	309-465-1	311-465-1	
				2.00	309-466	311-466	309-466-1	311-466-1	
				3.00	309-467	311-467	309-467-1	311-467-1	
12	25	12	75	0.25	309-470	311-470	309-470-1	311-470-1	
				0.50	309-471	311-471	309-471-1	311-471-1	
				0.75	309-472	311-472	309-472-1	311-472-1	
				1.00	309-473	311-473	309-473-1	311-473-1	
				1.25	309-474	311-474	309-474-1	311-474-1	
				1.50	309-475	311-475	309-475-1	311-475-1	
				2.00	309-476	311-476	309-476-1	311-476-1	
				3.00	309-477	311-477	309-477-1	311-477-1	
16	32	16	88	0.25	309-480	311-480	309-480-1	311-480-1	
				0.50	309-481	311-481	309-481-1	311-481-1	
				0.75	309-482	311-482	309-482-1	311-482-1	
				1.00	309-483	311-483	309-483-1	311-483-1	
				1.25	309-484	311-484	309-484-1	311-484-1	
				1.50	309-485	311-485	309-485-1	311-485-1	
				2.00	309-486	311-486	309-486-1	311-486-1	
				3.00	309-487	311-487	309-487-1	311-487-1	
20	38	20	100	0.25	309-490	311-490	309-490-1	311-490-1	
				0.50	309-491	311-491	309-491-1	311-491-1	
				0.75	309-492	311-492	309-492-1	311-492-1	
				1.00	309-493	311-493	309-493-1	311-493-1	
				1.25	309-494	311-494	309-494-1	311-494-1	
				1.50	309-495	311-495	309-495-1	311-495-1	
				2.00	309-496	311-496	309-496-1	311-496-1	
				3.00	309-497	311-497	309-497-1	311-497-1	

50° HELIX CORNER RADIUS ENDMILLS

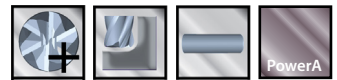

50°刃倒R角铣刀

6 and 8 Flutes	Coated
6和8刃	带涂层铣刀

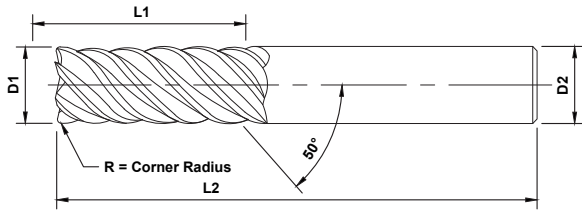

Standard, Series 534-0



Long, Series, 534-2

Length Key (K)

■ Stub
 ■ Standard
 ■ Long



K	OD	LOC	SHK	OAL	Radius	Flutes	PowerA
	D1	L1	D2	L2	R		PartID
6	6	18	6	58	0.5	6	534-002-1
		18	6	58	1	6	534-004-1
		32	6	75	0.5	6	534-202-1
		32	6	75	1	6	534-204-1
8	8	24	8	63	0.5	6	534-006-1
		24	8	63	1	6	534-008-1
		32	8	75	0.5	6	534-206-1
		32	8	75	1	6	534-208-1
10	10	30	10	75	0.5	6	534-010-1
		30	10	75	1	6	534-012-1
		50	10	100	0.5	6	534-210-1
		50	10	100	1	6	534-212-1
12	12	36	12	84	0.5	6	534-014-1
		36	12	84	1	6	534-016-1
		50	12	100	0.5	6	534-214-1
		50	12	100	1	6	534-216-1

50° HELIX CORNER RADIUS ENDMILLS

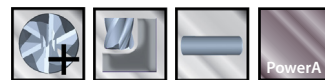

50°刃倒R角铣刀

Corner radius for extra strength and precision

圆“R” 有助于实现更高强度和精度



Length Key (K)

■ Stub
 ■ Standard
 ■ Long



K	OD	LOC	SHK	OAL	Radius	Flutes	PowerA
	D1	L1	D2	L2	R		PartID
14		42	14	84	0.5	6	534-018-1
		42	14	84	1	6	534-020-1
		50	14	100	0.5	6	534-218-1
		50	14	100	1	6	534-220-1
16		48	16	93	0.5	8	534-022-1
		48	16	93	1	8	534-024-1
		62	16	125	0.5	8	534-222-1
		62	16	125	1	8	534-224-1
18		54	18	100	0.5	8	534-026-1
		54	18	100	1	8	534-028-1
		62	18	125	0.5	8	534-226-1
		62	18	125	1	8	534-228-1
20		60	20	105	0.5	8	534-030-1
		60	20	105	1	8	534-032-1
		65	20	130	0.5	8	534-230-1
		65	20	130	1	8	534-232-1

6 FLUTE SQUARE END

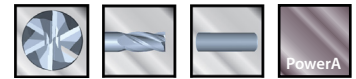

6刃平底铣刀

6 Flutes	Coated and Uncoated	6 flutes for superior finish
6刃	涂层和无涂层	六刃为获得优异的加工表面光洁度

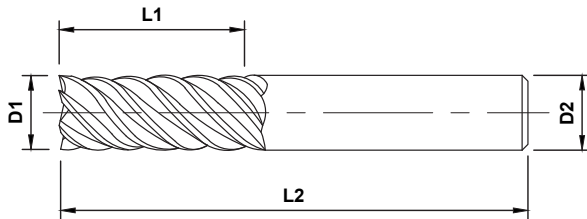

Series 312



Series 312, Power A

Length Key (K)

■ Stub
 ■ Standard
 ■ Long



K	OD	LOC	SHK	OAL	Uncoated	PowerA
	D1	L1	D2	L2	Part ID	Part ID
K	3	12	3	38	312-210	312-210-1
	4	14	4	50	312-214	312-214-1
	5	16	5	50	312-218	312-218-1
	6	19	6	63	312-220	312-220-1
	7	19	8	63	312-222	312-222-1
	8	21	8	63	312-224	312-224-1
	9	22	10	70	312-226	312-226-1
	10	25	10	70	312-228	312-228-1
	11	25	11	70	312-230	312-230-1
	12	25	12	75	312-232	312-232-1
	14	30	14	88	312-234	312-234-1
	16	32	16	88	312-236	312-236-1
	18	35	18	100	312-238	312-238-1
	20	38	20	100	312-240	312-240-1
	22	38	22	100	312-242	312-242-1
	25	38	25	100	312-244	312-244-1

SQUARE END • DOUBLE END



双端平底铣刀

2 and 4 Flutes	Coated and Uncoated
2和4刃	涂层和无涂层

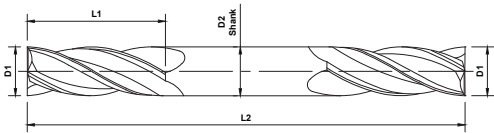

- Standard, Series 301
- Stub, Series 302



- Standard, Series 301 PowerA
- Stub, Series 302 PowerA

Length Key (K)

Stub Standard Long



K	OD	LOC	SHK	OAL	Uncoated		PowerA	
					2 Flute	4 Flute	2 Flute	4 Flute
	D1	L1	D2	L2				
1	1	2	3	38	302-102	302-302	302-102-1	302-302-1
	1.5	3	3	38	302-104	302-304	302-104-1	302-304-1
	2	4	3	38	302-106	302-306	302-106-1	302-306-1
	2.5	5	3	38	302-108	302-308	302-108-1	302-308-1
3	3	6	3	38	302-110	302-310	302-110-1	302-310-1
	3.5	9	3	50	301-102	301-302	301-102-1	301-302-1
4	4	7	4	50	302-112	302-312	302-112-1	302-312-1
	4.5	8	4	50	302-114	302-314	302-114-1	302-314-1
5	5	10	4	63	301-104	301-304	301-104-1	301-304-1
	5.5	10	5	50	302-116	302-316	302-116-1	302-316-1
6	6	10	5	50	302-118	302-318	302-118-1	302-318-1
	6.5	12	5	63	301-106	301-306	301-106-1	301-306-1
7	7	12	6	63	302-120	302-320	302-120-1	302-320-1
	7.5	16	6	63	301-108	301-308	301-108-1	301-308-1
8	8	10	7	63	302-122	302-322	302-122-1	302-322-1
	8.5	12	8	63	302-124	302-324	302-124-1	302-324-1
9	9	18	8	75	301-110	301-310	301-110-1	301-310-1
	9.5	12	9	70	302-126	302-326	302-126-1	302-326-1
10	10	12	10	70	302-128	302-328	302-128-1	302-328-1
	10.5	18	10	75	301-112	301-312	301-112-1	301-312-1
11	11	12	11	70	302-130	302-330	302-130-1	302-330-1
	11.5	16	12	75	302-132	302-332	302-132-1	302-332-1
12	12	25	12	100	301-114	301-314	301-114-1	301-314-1
	12.5	32	16	150	301-116	301-316	301-116-1	301-316-1

BALL END • DOUBLE END



双端球头铣刀

2 and 4 Flutes	Coated and Uncoated
2和4刃	涂层和无涂层

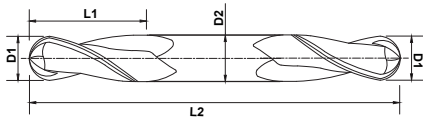

- Standard, Series 301
- Stub, Series 302



- Standard, Series 301, PowerA
- Stub, Series 302, PowerA

Length Key (K)

■ Stub
 ■ Standard
 ■ Long



K	OD	LOC	SHK	OAL	Uncoated		PowerA	
					2 Flute	4 Flute	2 Flute	4 Flute
	D1	L1	D2	L2				
1		2	3	38	302-002	302-202	302-002-1	302-202-1
1.5		3	3	38	302-004	302-204	302-004-1	302-204-1
2		4	3	38	302-006	302-206	302-006-1	302-206-1
2.5		5	3	38	302-008	302-208	302-008-1	302-208-1
3		6	3	38	302-010	302-210	302-010-1	302-210-1
		9	3	50	301-002	301-202	301-002-1	301-202-1
3.5		7	4	50	302-012	302-212	302-012-1	302-212-1
		8	4	50	302-014	302-214	302-014-1	302-214-1
4		10	4	63	301-004	301-204	301-004-1	301-204-1
		10	5	50	302-016	302-216	302-016-1	302-216-1
5		10	5	50	302-018	302-218	302-018-1	302-218-1
		12	5	63	301-006	301-206	301-006-1	301-206-1
6		12	6	63	302-020	302-220	302-020-1	302-220-1
		16	6	63	301-008	301-208	301-008-1	301-208-1
7		10	7	63	302-022	302-222	302-022-1	302-222-1
		12	8	63	302-024	302-224	302-024-1	302-224-1
8		18	8	75	301-010	301-210	301-010-1	301-210-1
		12	9	70	302-026	302-226	302-026-1	302-226-1
10		12	10	70	302-028	302-228	302-028-1	302-228-1
		18	10	75	301-012	301-212	301-012-1	301-212-1
11		12	11	70	302-030	302-230	302-030-1	302-230-1
		16	12	75	302-032	302-232	302-032-1	302-232-1
12		25	12	100	301-014	301-214	301-014-1	301-214-1
	16	32	16	150	301-016	301-216	301-016-1	301-216-1

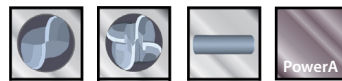

90° DRILLMILLS

90° 钻铣刀

2 and 4 Flutes	Coated and Uncoated	Chamfering, countersinking, spotting, and profile milling
2,4刃系列;	涂层和无涂层	倒角, 钻沉锥, 定位, 和成型铣削

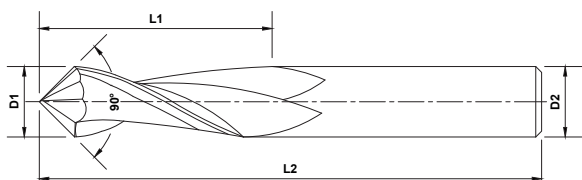

2 Flute, Series 314

4 Flute, Series 314

Length Key (K)

■ Stub
 ■ Standard
 ■ Long

Quick Ship Items



K	OD	LOC	SHK	OAL	Uncoated		PowerA	
					2 Flute	4 Flute	2 Flute	4 Flute
	D1	L1	D2	L2				
K	3	12	3	38	314-002	314-302	314-002-1	314-302-1
	4	14	4	50	314-004	314-304	314-004-1	314-304-1
	5	16	5	50	314-006	314-306	314-006-1	314-306-1
	6	19	6	63	314-008	314-308	314-008-1	314-308-1
	8	19	8	63	314-010	314-310	314-010-1	314-310-1
	10	22	10	70	314-012	314-312	314-012-1	314-312-1
	12	25	12	75	314-014	314-314	314-014-1	314-314-1
	16	32	16	88	314-016	314-316	314-016-1	314-316-1
	18	36	18	100	314-018	314-318	314-018-1	314-318-1

SQUARE END STRAIGHT FLUTE

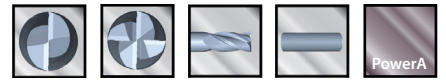

平底直刃铣刀

2 and 4 Flutes	Coated and Uncoated	Superb performance in hardened materials
2和4刃	涂层和无涂层	非常适合于硬化后的材料

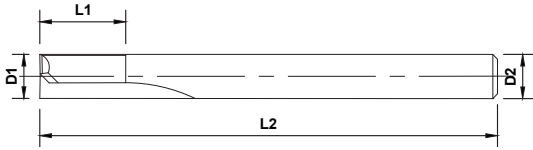

Standard, Series 303

Length Key (K)

Stub Standard Long



K	OD	LOC	SHK	OAL	Uncoated		PowerA	
					2 Flute	4 Flute	2 Flute	4 Flute
	D1	L1	D2	L2				
Standard	3	12	3	38	303-102	303-302	303-102-1	303-302-1
	4	14	4	50	303-104	303-304	303-104-1	303-304-1
	5	16	5	50	303-106	303-306	303-106-1	303-306-1
	6	19	6	63	303-108	303-308	303-108-1	303-308-1
	8	19	8	63	303-110	303-310	303-110-1	303-310-1
	10	22	10	70	303-112	303-312	303-112-1	303-312-1
	12	25	12	75	303-114	303-314	303-114-1	303-314-1
	16	32	16	88	303-116	303-316	303-116-1	303-316-1

BALL END STRAIGHT FLUTE

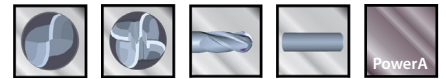

球头直刃铣刀

2 and 4 Flutes	Coated and Uncoated	Superb performance in hardened materials
2和4刃	涂层和无涂层	非常适合于硬化后的材料

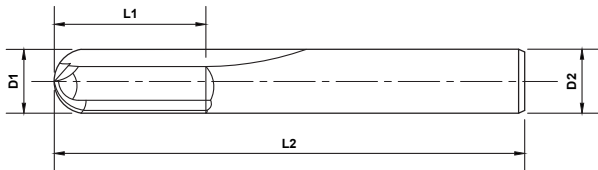

Standard, Series 303

Length Key (K)

K Stub
 Standard
Long



K	OD	LOC	SHK	OAL	Uncoated		PowerA	
					2 Flute	4 Flute	2 Flute	4 Flute
	D1	L1	D2	L2				
3		12	3	38	303-002	303-202	303-002-1	303-202-1
4		14	4	50	303-004	303-204	303-004-1	303-204-1
5		16	5	50	303-006	303-206	303-006-1	303-206-1
6		19	6	63	303-008	303-208	303-008-1	303-208-1
8		19	8	63	303-010	303-210	303-010-1	303-210-1
10		22	10	70	303-012	303-212	303-012-1	303-212-1
12		25	12	75	303-014	303-214	303-014-1	303-214-1
16		32	16	88	303-016	303-216	303-016-1	303-216-1

SQUARE END MINI MILLS

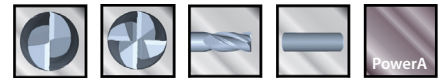

平底微铣刀

2 and 4 Flutes	Coated and Uncoated	Rigid, accurate design for micro applications
2和4刃	涂层和无涂层	刚性好结合精准的设计适用于微加工应用

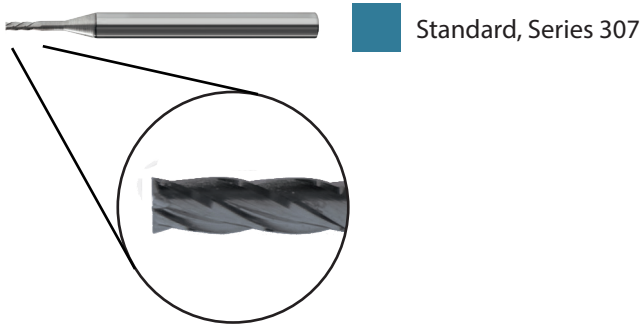
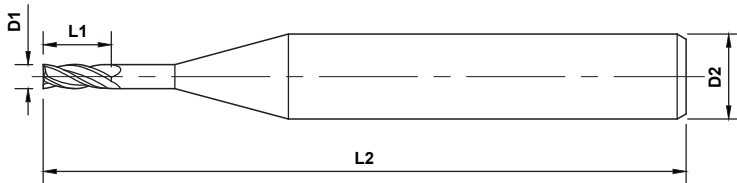

Length Key (K)

■ Stub
 ■ Standard
 ■ Long



K	OD	LOC	SHK	OAL	Uncoated		PowerA	
					2 Flute	4 Flute	2 Flute	4 Flute
	D1	L1	D2	L2				
Standard	0.2	0.6	3	38	307-102	307-502	307-102-1	307-502-1
	0.3	0.9	3	38	307-104	307-504	307-104-1	307-504-1
	0.4	1.2	3	38	307-106	307-506	307-106-1	307-506-1
	0.5	1.5	3	38	307-108	307-508	307-108-1	307-508-1
	0.6	1.8	3	38	307-110	307-510	307-110-1	307-510-1
	0.7	2.1	3	38	307-112	307-512	307-112-1	307-512-1
	0.8	2.4	3	38	307-114	307-514	307-114-1	307-514-1
	0.9	2.7	3	38	307-116	307-516	307-116-1	307-516-1
	1.0	3.0	3	38	309-202	311-202	309-202-1	311-202-1
	1.5	5.0	3	38	309-204	311-204	309-204-1	311-204-1

BALL END MINI MILLS

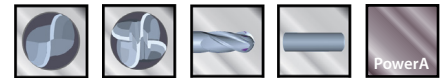

球头微铣刀

2 and 4 Flutes	Coated and Uncoated	Rigid, accurate design for micro applications
2和4刃	涂层和无涂层	刚性好结合精准的设计适用于微加工应用

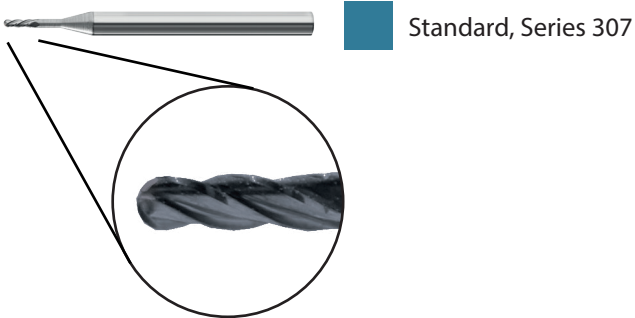
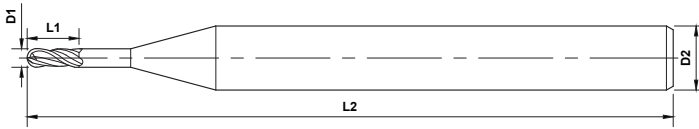

Length Key (K)

■ Stub
 ■ Standard
 ■ Long



K	OD	LOC	SHK	OAL	Uncoated		PowerA	
					2 Flute	4 Flute	2 Flute	4 Flute
Standard	D1	L1	D2	L2				
	0.2	0.6	3	38	307-002	307-402	307-002-1	307-402-1
	0.3	0.9	3	38	307-004	307-404	307-004-1	307-404-1
	0.4	1.2	3	38	307-006	307-406	307-006-1	307-406-1
	0.5	1.5	3	38	307-008	307-408	307-008-1	307-408-1
	0.6	1.8	3	38	307-010	307-410	307-010-1	307-410-1
	0.7	2.1	3	38	307-012	307-412	307-012-1	307-412-1
	0.8	2.4	3	38	307-014	307-414	307-014-1	307-414-1
	0.9	2.7	3	38	307-016	307-416	307-016-1	307-416-1
	1.0	3.0	3	38	309-002	311-002	309-002-1	311-002-1
1.5	5.0	3	38	309-004	311-004	309-004-1	311-004-1	

40° SHORT FLUTE SQUARE

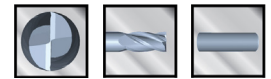

短刃平底铣刀

2 Flute	Uncoated
2刃	无涂层

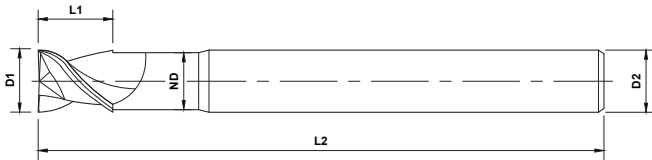

Standard, Series 536

Length Key (K)

■ Stub
 ■ Standard
 ■ Long



K	OD	LOC	SHK	OAL	Reach	Neck	Uncoated
	D1	L1	D2	L2	L3	ND	Part ID
Standard	3	3	6	75	12mm	2.5	536-202
	4	4	6	75	15mm	3.5	536-204
	5	5	6	75	20mm	4.5	536-206
	6	6	6	100	20mm	5.0	536-208
	8	6	8	100	25mm	7.0	536-210
	10	10	10	100	25mm	9.0	536-212
	12	12	12	100	40mm	11.0	536-214
	14	12	14	125	50mm	13.0	536-216
	16	12	16	125	50mm	14.0	536-218
	18	14	18	125	50mm	16.0	536-220
20	16	20	150	65mm	16.0	536-222	

50° SHORT FLUTE BALL

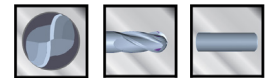

短刃球头铣刀

2 Flute	Uncoated
2刃	无涂层



Standard, Series 535

Length Key (K)

■ Stub
 ■ Standard
 ■ Long



K	OD	LOC	SHK	OAL	Uncoated
	D1	L1	D2	L2	Part ID
Standard	2	4	6	75	535-002
	3	5	6	75	535-004
	4	6	6	75	535-006
	5	7	6	75	535-008
	6	8	6	100	535-010
	8	10	8	100	535-012
	10	12	10	100	535-014
	12	16	12	100	535-016
	14	18	14	100	535-018
	16	20	16	125	535-020
	18	22	18	125	535-022
	20	25	20	150	535-024

50° SHORT FLUTE SQUARE REDUCED SHANK

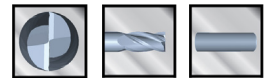

短刃平底铣刀缩径刀杆

2 Flute	Short Flute Square Reduced Shank	Uncoated
2刃	短刃平底铣刀 缩径杆	无涂层

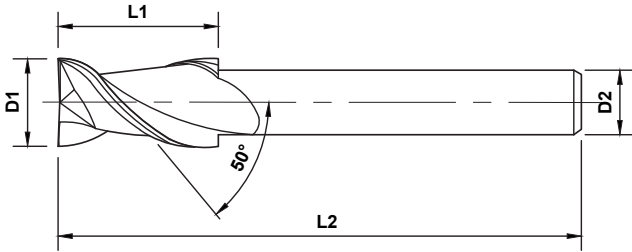

Standard, Series 535

Length Key (K)

■ Stub
 ■ Standard
 ■ Long



K	OD	LOC	SHK	OAL	Part ID
	D1	L1	D2	L2	
Standard	6	6	5	100	535-402
	8	8	7	100	535-404
	10	10	9	100	535-406
	12	12	11	100	535-408
	14	14	12	125	535-410
	16	16	14	125	535-412
	18	18	16	125	535-414
	20	20	18	150	535-416

50° SHORT FLUTE BALL REDUCED SHANK

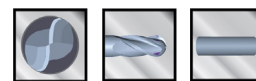

短刃球头端铣刀 缩径刀杆

2 Flute	Short Flute Ball Reduced Shank	Uncoated
2刃	短刃平底铣刀 缩径杆	无涂层

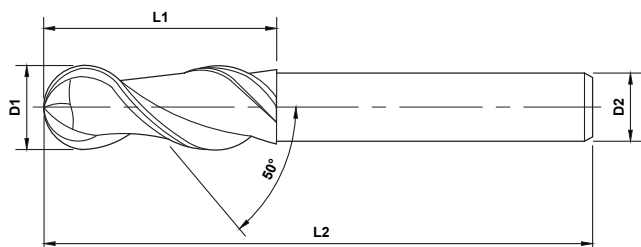

Standard, Series 535

Length Key (K)

■ Stub
 ■ Standard
 ■ Long



K	OD	LOC	SHK	OAL	Part ID
	D1	L1	D2	L2	
	6	6	5	100	535-202
	8	8	7	100	535-204
	10	10	9	100	535-206
	12	12	11	100	535-208
	14	14	12	125	535-210
	16	16	14	125	535-212
	18	18	16	125	535-214
	20	20	18	150	535-216

SHORT FLUTE NECKED SQUARE ENDMILLS



短刃缩颈平底铣刀

2 and 3 Flute	40° Helix	Uncoated
2和3刃	40° 螺旋刃设计	无涂层

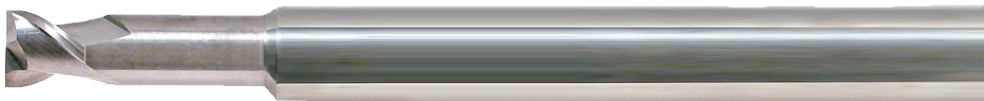
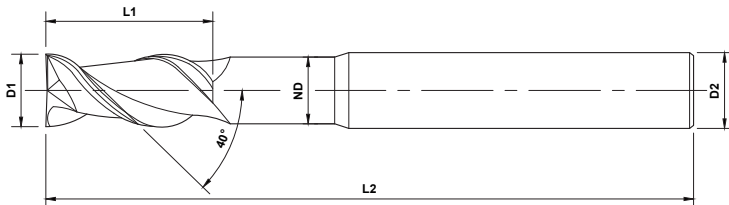

Standard, Series 536

Length Key (K)

■ Stub
 ■ Standard
 ■ Long



OD	LOC	SHK	OAL	Reach	Neck		
D1	L1	D2	L2	L3	ND	Flutes	Part ID
6	6	6	150	20mm	5	2	536-402
8	8	8	150	25mm	7	2	536-404
10	10	10	150	25mm	9	2	536-406
12	12	12	150	40mm	11	2	536-408
14	14	14	175	50mm	13	2	536-410
16	16	16	200	50mm	14	2	536-412
18	18	18	200	50mm	16	2	536-414
20	20	20	200	65mm	18	2	536-416

OD	LOC	SHK	OAL	Reach	Neck		
D1	L1	D2	L2	L3	ND	Flutes	Part ID
6	6	6	100	20mm	5	3	536-602
8	6	8	100	25mm	7	3	536-604
10	10	10	100	25mm	9	3	536-606
12	12	12	100	40mm	11	3	536-608
14	12	14	125	50mm	13	3	536-610
16	12	16	125	50mm	14	3	536-612
18	14	18	125	50mm	16	3	536-614
20	16	20	150	65mm	18	3	536-616

SHORT FLUTE NECKED BALL ENDMILLS

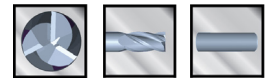

短刃缩颈球头端铣刀

3 Flute	50° Helix	Uncoated
3刃	50° 螺旋刃设计	无涂层

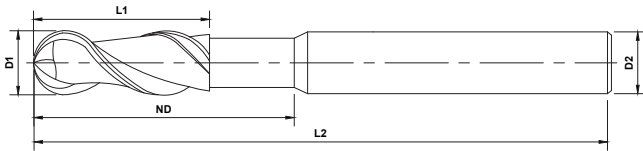

Standard, Series 536

Length Key (K)

■ Stub
 ■ Standard
 ■ Long



OD	LOC	SHK	OAL	Reach	Neck	Part ID
D1	L1	D2	L2	L3	ND	
6	8	6	150	20mm	5	535-602
8	10	8	150	25mm	7	535-604
10	12	10	150	25mm	9	535-606
12	16	12	150	40mm	11	535-608
14	18	14	175	50mm	13	535-610
16	20	16	200	50mm	14	535-612
18	22	18	200	50mm	16	535-614
20	25	20	200	65mm	18	535-616

SHORT FLUTE NECKED CORNER RADIUS

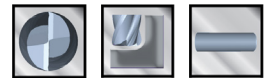

短刃缩径缩颈倒R角铣刀

2 Flute	40° Helix	Uncoated
2刃	40° 螺旋刃设计	无涂层

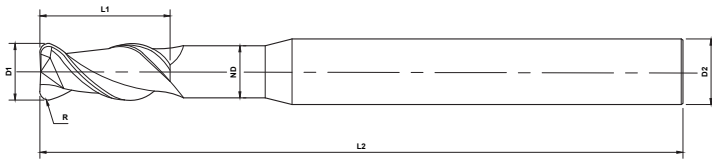

Standard, Series 536

Length Key (K)

■ Stub
 ■ Standard
 ■ Long



K	OD	LOC	SHK	OAL	Reach	Neck	Radius	Part ID
	D1	L1	D2	L2	L3	ND	R	
3		3	6	75	12mm	2.5	0.5	536-002
		3	6	75	12mm	2.5	1.0	536-004
4		4	6	75	15mm	3.5	0.5	536-006
		4	6	75	15mm	3.5	1.0	536-008
5		5	6	75	20mm	4.5	0.5	536-010
		5	6	75	20mm	4.5	1.0	536-012
6		6	6	100	20mm	5	0.5	536-014
		6	6	100	20mm	5	1.0	536-016
		6	6	100	20mm	5	1.5	536-018
		6	6	100	20mm	5	2.0	536-020
		6	6	100	20mm	5	2.5	536-021
		6	6	100	20mm	5	3.0	536-021
8		8	8	100	25mm	7	0.5	536-022
		8	8	100	25mm	7	1.0	536-024
		8	8	100	25mm	7	1.5	536-026
		8	8	100	25mm	7	2.0	536-028
		8	8	100	25mm	7	2.5	536-029
		8	8	100	25mm	7	3.0	536-030

SHORT FLUTE NECKED CORNER RADIUS



短刃缩径缩颈倒R角铣刀



Length Key (K)

■ Stub
 ■ Standard
 ■ Long



K	OD	LOC	SHK	OAL	Reach	Neck	Radius	Part ID
	D1	L1	D2	L2	L3	ND	R	
10	10	10	10	100	25mm	9	0.5	536-032
		10	10	100	25mm	9	1.0	536-034
		10	10	100	25mm	9	1.5	536-036
		10	10	100	25mm	9	2.0	536-038
		10	10	100	25mm	9	2.35	536-039
		10	10	100	25mm	9	3.0	536-040
12	12	12	12	100	40mm	11	0.5	536-042
		12	12	100	40mm	11	1.0	536-044
		12	12	100	40mm	11	1.5	536-046
		12	12	100	40mm	11	2.0	536-048
		12	12	100	40mm	11	2.5	536-049
		12	12	100	40mm	11	3.0	536-050
14	14	14	14	125	50mm	13	0.5	536-052
		14	14	125	50mm	13	1	536-054
16	16	16	16	125	50mm	14	0.5	536-056
		16	16	125	50mm	14	2.0	536-058
		16	16	125	50mm	14	1.5	536-060
		16	16	125	50mm	14	2.0	536-062
		16	16	125	50mm	14	2.5	536-063
		16	16	125	50mm	14	3.0	536-064
		16	16	125	50mm	14	4.0	536-066
20	20	20	20	150	65mm	18	0.5	536-068
		20	20	150	65mm	18	1.0	536-070
		20	20	150	65mm	18	1.5	536-072
		20	20	150	65mm	18	2.0	536-074
		20	20	150	65mm	18	2.5	536-075
		20	20	150	65mm	18	3.0	536-076
		20	20	150	65mm	18	4.0	536-078

EXTRA LONG SQUARE ENDMILL

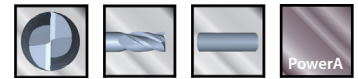

超长2刃 平底铣刀

2 Flutes	Extra Long Square	Coated and Uncoated
2刃	超长2刃 平底铣刀	无涂层和涂层

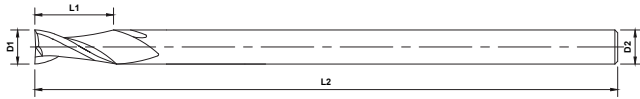

Length Key (K)

■ Stub
 ■ Standard
 ■ Long



	OD	LOC	SHK	OAL	Uncoated	PowerA
	D1	L1	D2	L2	Part ID	Part ID
6		38	6	100	315-202	315-202-1
		75	6	150	315-204	315-204-1
		75	6	200	315-206	315-206-1
		75	8	200	315-208	315-208-1
8		42	8	100	315-210	315-210-1
		75	8	150	315-212	315-212-1
		75	8	200	315-214	315-214-1
		75	10	200	315-216	315-216-1
10		75	10	150	315-218	315-218-1
		75	10	200	315-220	315-220-1
12		75	12	150	315-222	315-222-1
		75	12	200	315-224	315-224-1
14		62	14	125	315-226	315-226-1
		75	14	150	315-228	315-228-1
		75	16	200	315-230	315-230-1
16		75	16	200	315-232	315-232-1
18		75	18	200	315-234	315-234-1
20		75	20	200	315-236	315-236-1

EXTRA LONG BALL ENDMILL

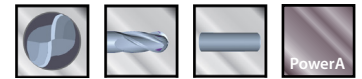

超长2刃球头铣刀

2 Flutes	Extra Long Ball	Coated and Uncoated
2刃	超长2刃球头铣刀	无涂层和涂层

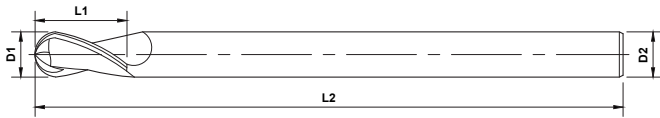

Standard, Series 315

Length Key (K)

■ Stub
 ■ Standard
 ■ Long



	OD	LOC	SHK	OAL	Uncoated	PowerA
	D1	L1	D2	L2	Part ID	Part ID
6		38	6	100	315-002	315-002-1
		75	6	150	315-004	315-004-1
		75	6	200	315-006	315-006-1
		75	8	200	315-008	315-008-1
8		42	8	100	315-010	315-010-1
		75	8	150	315-012	315-012-1
		75	8	200	315-014	315-014-1
		75	10	200	315-016	315-016-1
10		75	10	150	315-018	315-018-1
		75	10	200	315-020	315-020-1
12		75	12	150	315-022	315-022-1
		75	12	200	315-024	315-024-1
14		62	14	125	315-026	315-026-1
		75	14	150	315-028	315-028-1
		75	16	200	315-030	315-030-1
16		75	16	200	315-032	315-032-1
18		75	18	200	315-034	315-034-1
20		75	20	200	315-036	315-036-1

HIGH PERFORMANCE ENDMILLS

高性能立铣刀

- **V4 and V5**
- **HY5**
- **F45**
- **Mold Mills**
- **TwisterMills**
- **Roughers**
- **AxMills**
- **45° HyperMills**
- **55° AlumaZips**

The customized geometries of our High Performance Endmills make these tool problem solvers for challenging milling operations.













定制的几何形状或我们的高性能立铣刀使这些刀具问题解决方案适用于具有挑战性的铣削操作。

The logo for V4 endmills, featuring the letters 'V4' in a bold, red, italicized font with a yellow outline and a small gear-like symbol to the right.The logo for V5 endmills, featuring the letters 'V5' in a blue, italicized font with a yellow outline and a small gear-like symbol to the right.The logo for F45 endmills, featuring the letters 'F45' in a blue, italicized font with a red outline and a small gear-like symbol to the right.The logo for HY5 endmills, featuring the letters 'HY5' in a blue, italicized font with a small gear-like symbol to the right.The logo for AxMill endmills, featuring the letters 'AxMill' in a black, stylized font with a gear-like symbol to the right.

LEGENDS

图示说明

Features 产品特点

	2 Flutes 2刃		Multi-Flute 多刃		Ball End 球头铣刀
	3 Flutes 3刃		Plain Shank 普通刀柄		Double End Sq. 双端平底方头铣刀
	4 Flutes 4刃		Corner Radius 倒R角		Double End Ball 双端球头铣刀
	6 Flutes 6刃		Square End 平底铣刀		Weldon Flat 侧固刀柄

Mastercut's Superior Carbide Blend – A-Gr-SiV (Active Grain Sized Volume)

Our superior tungsten carbide gives you the ability to be *aggressive* when you need to be. Growth inhibitors in our submicron carbide blanks maintain the most consistent grain size available, giving you superior hardness and toughness.

迈斯卡的超级硬质合金材质 - A-Gr-SiV

迈斯卡的超级硬质合金材质 - 拥有均匀亚微米晶粒，完美的硬度和韧性的结合，保证我们的刀具可以面对各种挑战时游刃有余。

Coatings 涂层







	PowerA PowerA (AlTiN)		Uncoated 无涂层		PowerNR PowerNR (nACro)
	PowerT PowerT (TiN)		PowerN PowerN (nACo)		
	PowerZ PowerZ (ZrN)		PowerC PowerC (TiCN)		

TABLE OF CONTENTS - 目录









































































































































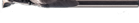

	V4, V5, HY5 Tool Features V4, V5, HY5刀具特征	48	   	 
	F45, AxMill, HyperMill and AlumaZip Tool Features AxMill和Alumazip刀具特征	49	   	 
	V4 Square Endmills V4平底铣刀	50	   	 
	V4 Ball Endmills V4球头铣刀	52	   	 
	V4 Corner Radius Endmills V4倒R角铣刀	54	   	 
	V5 Square Endmills V5平底铣刀	61	   	 
	V5 Ball Endmills V5球头铣刀	62	   	 
	V5 Corner Radius Endmills V5 倒R角铣刀	63	   	 
	HY5 Square Endmills HY5 平底铣刀	64	   	 
	HY5 Corner Radius Endmills HY5 倒R角铣刀	65	   	 
	F45 6FL Square Endmills F45, 6刃平底铣刀	70	   	 
	F45 6FL Corner Radius Endmills F45, 6刃倒R角铣刀	71	   	 
	Ball Necked Mold Mills 球头缩颈模1具铣刀	72	   	 

TABLE OF CONTENTS - 目录

	Ball Necked Extended Reach Mold Mills 加长缩颈系列	72	     
	3FL 60° Helix Twister Mills 3刃 60°螺旋刃铣刀	73	  
	Roughers - Coarse Pitch 梳齿粗铣刀-粗牙	74	      
	Roughers - Fine Pitch 梳齿粗铣刀-细牙	75	      
	Roughers - Medium Pitch 梳齿粗铣刀-中牙	76	      
	AxMills - Square End 铝合金专用Axmill平底铣刀	77	
	AxMills - Corner Radius 铝合金专用Axmill倒R角铣刀	78	
	AxMills - Square End Chipbreaker 带碎屑刃Axmill 平底铣刀	79	
	AxMills - Corner Radius Chipbreaker 带碎屑刃Axmill倒R角铣刀	80	
	45° HyperMills 45°螺旋刃平底铝合金刀	81	
	55° AlumaZips 55°螺旋刃平底铝合金铣刀	81	

HIGH PERFORMANCE TOOL FEATURES

高性能工具功能



V4

- The variable 4 flute design interrupts harmonic vibrations to provide improved feeds and speeds, superior finishes and longer tool life
- Ideal for roughing to finishing operations, in both peripheral and slotting functions
- Available in our proprietary and proven PowerA (AlTiN) and the optional nanocomposite PowerNR (nACRo) for difficult-to-machine alloys
- 非等分变刃角设计破除了加工震动的协调，因而使得切削实现更高的速度和进给，更好的光洁度。同时刀具的寿命更高。
- 无论是铣轮廓还是铣沟槽，V4 在用于粗铣和精铣时都十分理想；
- 有业界广泛认同并经我们的改进AlTiN基 PowerA涂层（拥有知识产权和其它先进纳米复合涂层的选择，以满足加工各种难加工合金的需要；
- 也提供超高性能V4 铣刀系列。



V5

- An impressive combination of variable flutes, a thicker core and eccentrically-ground relief, adding to performance and value
- A strong, stable performer sure to provide chatter-free finishes and aggressive material removal rates
- Available in PowerA (AlTiN) and nanocomposite PowerNR (nACRo) where tool-life demands the very finest coating available
- 5 Flute design
- 具有完美的5个不等切削刃，粗芯和偏心磨削和后退，以进一步提高切削性能；
- 其卓越的稳定性确保了无振动切割和更高的金属去除效率；
- 选择其他最先进的纳米复合材料涂层，采用AlTiN基PowerA涂层，确保最佳的刀具寿命；
- 5刀片设计。



HJS

- High performing, broad spectrum semi-finisher/finisher
- Outstanding in stainless steels, high temp alloys, mold steels to 45 Rc
- 5 flute, 45° helix, eccentric grind provides a smooth cutting action with superb chip evacuation
- 20% + increase in productivity versus 4 fluted endmills
- Minimal tool deflection equals better part tolerance
- Stub, standard and long lengths, in square end and corner radius options
- Coated with PowerA (AlTiN)
- 高性能通用型精铣和半精铣刀；
- 在加工不锈钢，高温合金和45Rc硬度范围内的 模具钢表现优异；
- 5刃，45°螺旋角设计结合偏心研磨工艺使该刀具切削平滑，排屑流畅；
- 与4 刃铣刀相比，切削效率提高了20%；
- 最大限度地降低刀具的侧压变形使得加工产品的精度进一步提高；
- 该刀具系列有短，中，长三种长度及平底，到R角的选择；
- 标配是PowerA涂层。

V4, V5 AND HY5

高性能工具功能



- 6 flute, high performance finisher providing superb finishes in stainless steels, nickel alloys, Inconels, titanium and more
- 45° degree helix provides superb chip evacuation and excellent shearing action.
- Reduced load pressures and super-stiff design promotes less chatter and the best performance in light finishing applications
- Coated with PowerA (AlTiN)

- 这是一款6刃的高性能精铣刀，在加工不锈钢，镍基合金、镍基高温合金，钛合金等难切削合金时可以得到超优的表面光洁度；
- 45°旋转刃设计使得刀刃具有良好的剪削效果，排屑通畅优良；
- 降低的切削压力和超级刚性设计能有效避免切削过程中的振刀，在小切深的精铣过程中表现优异；
- 标配是PowerA涂层。



- High performance design for aggressive aluminum milling
- Incorporates a high shear, high rake geometry
- 2 and 3 flute, square end, corner radius and ball end styles
- Available in uncoated and optional PowerZ (Zirconium Nitride) coating
- Chipbreaker option where chip control or spindle horsepower is a concern

- 采用了高效切削铝合金及有色金属的最优化设计；
- 结合高剪削，多重高刃角的刃形设计；
- 有2刃& 3刃，平底，倒R角和球头等不同规格的选择；
- 可以选择无涂层或铝合金专用涂层PowerZ（氮化锆）；
- 在有断屑需求或机器的功率不足时，也有梳齿刃设计的选择。



HyperMill

- Aggressive metal removal rates in aluminum and non-ferrous materials
- 45° helix increases stiffness and improves surface finish
- 2 Flute design

- 高效切削铝合金和有色金属
- 45°旋转刃设计提高刀具得刚度并改善加工的光洁度；
- 标配2刃设计。



AlumaZip

- High performance 2 Flute design for high metal removal rates in aluminum and non-ferrous materials
- 55° helix combines a super-stiff profile with a rapid evacuation of chips
- High helix fluting increases contact area, thereby imparting better surface finishes

- 高效切削铝合金和有色金属的设计；
- 55°旋转刃设计使该刀具具有优异的刚度和快速排屑的功能；
- 高旋转刃设计增加刀刃的与工件的接触面积，因而可以有更好的表面光洁度。

V4 SQUARE ENDMILLS

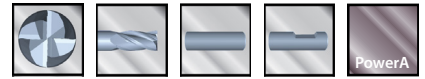

V4平底铣刀

4 Flutes	Coated with or without flat	Unique variable design for faster speeds and feeds
4刃	涂层, 普通刀杆和侧固刀杆	独到的可变刃设计使得 刀具可以更高转速和进给

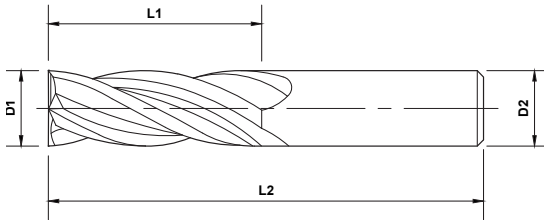

Length Key (K)

■ Stub
 ■ Standard
 ■ Long

Quick Ship Items



K	OD	LOC	SHK	OAL	PowerA	
					No Flat	With Flat
3	D1	12	3	38	500-002-1	500-002W-1
		8	6	57	500-004-1	500-004W-1
		20	3	65	501-002-1	501-002W-1
3.5	D1	6	3	38	502-002-1	502-002W-1
		7	6	57	500-006-1	500-006W-1
4	D1	14	4	50	500-008-1	500-008W-1
		11	6	57	500-010-1	500-010W-1
		20	4	65	501-004-1	501-004W-1
4.5	D1	8	4	50	502-004-1	502-004W-1
		9	6	57	500-012-1	500-012W-1
5	D1	16	5	50	500-014-1	500-014W-1
		13	6	57	500-016-1	500-016W-1
		20	5	75	501-006-1	501-006W-1
6	D1	10	5	50	502-006-1	502-006W-1
		19	6	63	500-018-1	500-018W-1
		25	6	75	501-008-1	501-008W-1
		12	6	50	502-008-1	502-008W-1
		13	6	57	502-010-1	502-010W-1

- Flats are not recommended on shank diameters smaller than 8mm.
- 不建议在直径小于8mm的刀柄上使用平面。

V4 SQUARE ENDMILLS

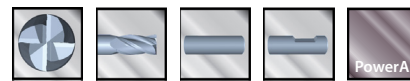

V4平底铣刀

HIGH PERFORMANCE ENDMILLS



Length Key (K)

■ Stub
 ■ Standard
 ■ Long



Quick Ship Items

K	OD		SHK		PowerA	
	D1	LOC	D2	OAL	No Flat	With Flat
8	8	19	8	63	500-020-1	500-020W-1
		25	8	75	501-010-1	501-010W-1
		12	8	50	502-012-1	502-012W-1
10	10	22	10	70	500-022-1	500-022W-1
		38	10	100	501-012-1	501-012W-1
		14	10	50	502-014-1	502-014W-1
12	12	25	12	75	500-024-1	500-024W-1
		50	12	100	501-014-1	501-014W-1
		16	12	63	502-016-1	502-016W-1
14	14	25	14	88	500-026-1	500-026W-1
		56	14	125	501-016-1	501-016W-1
16	16	32	16	88	500-028-1	500-028W-1
		56	16	150	501-018-1	501-018W-1
18	18	36	18	100	500-030-1	500-030W-1
		56	18	150	501-020-1	501-020W-1
20	20	38	20	100	500-032-1	500-032W-1
		56	20	150	501-022-1	501-022W-1
25	25	38	25	100	500-034-1	500-034W-1
		70	25	150	501-024-1	501-024W-1

- Flats are not recommended on shank diameters smaller than 8mm.
- 不建议在直径小于8mm的刀柄上使用平面。

V4 BALL ENDMILLS

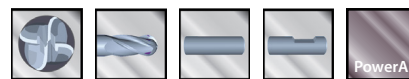

V4球头铣刀

4 Flutes 4刃	Coated with or without flat 涂层, 普通刀杆和侧固刀杆	Unique variable design for faster speeds and feeds 独到的可变刃设计使得 刀具可以更高转速和进给
----------------	--	--

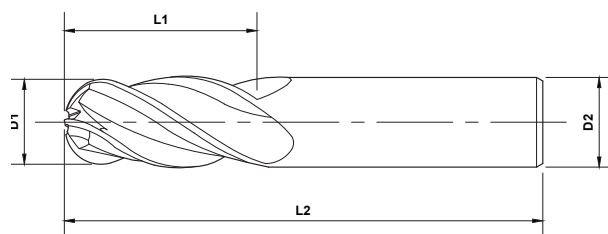

PowerA



Length Key (K)



Quick Ship Items

K	OD D1	LOC L1	SHK D2	OAL L2	PowerA	
					No Flat	With Flat
3	3	6	3	38	502-202-1	502-202W-1
		8	6	57	500-204-1	500-204W-1
		12	3	38	500-202-1	500-202W-1
		20	3	65	501-202-1	501-202W-1
3.5	3.5	7	6	57	500-206-1	500-206W-1
		8	4	50	502-204-1	502-204W-1
4	4	11	6	57	500-210-1	500-210W-1
		14	4	50	500-208-1	500-208W-1
		20	4	65	501-204-1	501-204W-1
		9	6	57z	500-212-1	500-212W-1
5	5	10	5	50	502-206-1	502-206W-1
		13	6	57	500-216-1	500-216W-1
		16	5	50	500-214-1	500-214W-1
		25	5	75	501-206-1	501-206W-1
6	6	12	6	50	502-208-1	502-208W-1
		13	6	57	502-210-1	502-210W-1
		19	6	63	500-218-1	500-218W-1
		25	6	75	501-208-1	501-208W-1

- Flats are not recommended on shank diameters smaller than 8mm.
- 不建议在直径小于8mm的刀柄上使用平面。

V4 BALL ENDMILLS

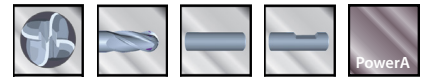

V4球头铣刀

HIGH PERFORMANCE ENDMILLS



Length Key (K)



Quick Ship Items



K	OD	LOC	SHK	OAL	PowerA	
					No Flat	With Flat
	D1	L1	D2	L2		
8		12	8	50	502-212-1	502-212W-1
		19	8	63	500-220-1	500-220W-1
		25	8	75	501-210-1	501-210W-1
10		14	10	50	502-214-1	502-214W-1
		22	10	70	500-222-1	500-222W-1
		38	10	100	501-212-1	501-212W-1
12		16	12	63	502-216-1	502-216W-1
		25	12	75	500-224-1	500-224W-1
		50	12	100	501-214-1	501-214W-1
14		25	14	88	500-226-1	500-226W-1
		56	14	125	501-216-1	501-216W-1
16		32	16	88	500-228-1	500-228W-1
		56	16	150	501-218-1	501-218W-1
18		36	18	100	500-230-1	500-230W-1
		56	18	150	501-220-1	501-220W-1
20		38	20	100	500-232-1	500-232W-1
		56	20	150	501-222-1	501-222W-1
25		38	25	100	500-234-1	500-234W-1
		70	25	150	501-224-1	501-224W-1

- Flats are not recommended on shank diameters smaller than 8mm.
- 不建议在直径小于8mm的刀柄上使用平面。

V4 CORNER RADIUS ENDMILLS

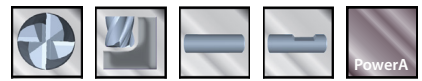

V4倒R角刀铣刀

4 Flutes 4刃	Coated with or without flat 涂层, 普通刀杆和侧固刀杆
Unique variable design for faster speeds and feeds 独到的可变刃设计使得 刀具可以更高转速和进给	Quiet operation and better finish 运行安静和更好的表面光洁度

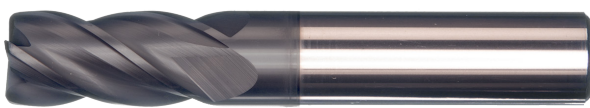
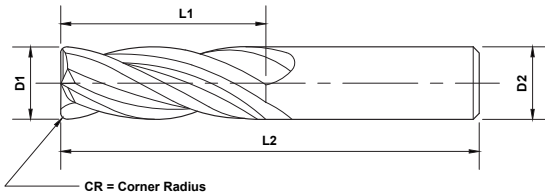

PowerA



Length Key (K)

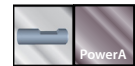

Quick Ship Items

K	OD	LOC	SHK	OAL	Radius	PowerA		
	D1	L1	D2	L2	R	No Flat	With Flat	
3	6	6	3	38	0.25	502-401-1	502-401W-1	
		6	3	38	0.50	502-402-1	502-402W-1	
		6	3	38	0.75	502-403-1	502-403W-1	
		6	3	38	1.00	502-404-1	502-404W-1	
	8	8	6	6	57	0.25	500-410-1	500-410W-1
			8	6	57	0.50	500-411-1	500-411W-1
		12	3	38	0.25	500-400-1	500-400W-1	
			3	38	0.50	500-401-1	500-401W-1	
		20	3	65	0.25	501-400-1	501-400W-1	
				65	0.50	501-401-1	501-401W-1	
			3	65	0.75	501-402-1	501-402W-1	
				65	1.00	501-403-1	501-403W-1	
4	8	4	50	0.25	502-410-1	502-410W-1		
		4	50	0.50	502-411-1	502-411W-1		
		4	50	0.75	502-412-1	502-412W-1		
		4	50	1.00	502-413-1	502-413W-1		
	11	6	57	0.25	500-430-1	500-430W-1		
			57	0.50	500-431-1	500-431W-1		
		6	57	1.00	500-433-1	500-433W-1		
			50	0.25	500-420-1	500-420W-1		
		14	4	50	0.50	500-421-1	500-421W-1	
				50	0.75	500-422-1	500-422W-1	
			4	50	1.00	500-423-1	500-423W-1	

- Flats are not recommended on shank diameters smaller than 8mm.
- 不建议在直径小于8mm的刀柄上使用平面。

V4 CORNER RADIUS ENDMILLS

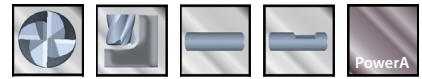

V4倒R角刀铣刀



HIGH PERFORMANCE ENDMILLS

Length Key (K)



Quick Ship Items



K	OD	LOC	SHK	OAL	Radius	PowerA	
	D1	L1	D2	L2	R	No Flat	With Flat
4	20	4	65	0.25	501-410-1	501-410W-1	
	20	4	65	0.50	501-411-1	501-411W-1	
	20	4	65	0.75	501-412-1	501-412W-1	
	20	4	65	1.00	501-413-1	501-413W-1	
5	10	5	50	0.25	502-420-1	502-420W-1	
	10	5	50	0.50	502-421-1	502-421W-1	
	10	5	50	0.75	502-422-1	502-422W-1	
	10	5	50	1.00	502-423-1	502-423W-1	
	16	5	50	0.25	500-440-1	500-440W-1	
	16	5	50	0.50	500-441-1	500-441W-1	
	16	5	50	0.75	500-442-1	500-442W-1	
	16	5	50	1.00	500-443-1	500-443W-1	
	20	5	75	0.25	501-420-1	501-420W-1	
	20	5	75	0.50	501-422-1	501-422W-1	
	20	5	75	0.75	501-423-1	501-423W-1	
	20	5	75	1.00	501-424-1	501-424W-1	
	13	6	57	0.25	500-450-1	500-450W-1	
	13	6	57	0.50	500-451-1	500-451W-1	
13	6	57	1.00	500-453-1	500-453W-1		
6	12	6	50	0.25	502-430-1	502-430W-1	
	12	6	50	0.50	502-431-1	502-431W-1	
	12	6	50	0.75	502-432-1	502-432W-1	
	12	6	50	1.00	502-433-1	502-433W-1	
	12	6	50	1.25	502-434-1	502-434W-1	
	12	6	50	1.50	502-435-1	502-435W-1	
	12	6	50	2.00	502-436-1	502-436W-1	
	13	6	57	0.25	502-440-1	502-440W-1	
13	6	57	0.50	502-441-1	502-441W-1		

- Flats are not recommended on shank diameters smaller than 8mm.
- 不建议在直径小于8mm的刀柄上使用平面。

V4 CORNER RADIUS ENDMILLS

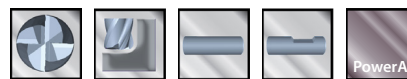

V4倒R角刀铣刀



Length Key (K)

■ Stub
 ■ Standard
 ■ Long

Quick Ship Items



K	OD	LOC	SHK	OAL	Radius	PowerA	
	D1	L1	D2	L2	R	No Flat	With Flat
6	13	6	57	1.00	502-443-1	502-443W-1	
	13	6	57	1.50	502-445-1	502-445W-1	
	13	6	57	2.00	502-446-1	502-446W-1	
	19	6	63	0.25	500-460-1	500-460W-1	
	19	6	63	0.50	500-461-1	500-461W-1	
	19	6	63	0.75	500-462-1	500-462W-1	
	19	6	63	1.00	500-463-1	500-463W-1	
	19	6	63	1.25	500-464-1	500-464W-1	
	19	6	63	1.50	500-465-1	500-465W-1	
	19	6	63	2.00	500-466-1	500-466W-1	
	25	6	75	0.25	501-430-1	501-430W-1	
	25	6	75	0.50	501-431-1	501-431W-1	
	25	6	75	0.75	501-432-1	501-432W-1	
	25	6	75	1.00	501-433-1	501-433W-1	
	25	6	75	1.25	501-434-1	501-434W-1	
	25	6	75	1.50	501-435-1	501-435W-1	
25	6	75	2.00	501-436-1	501-436W-1		
8	12	8	50	0.50	502-451-1	502-451W-1	
	12	8	50	0.75	502-452-1	502-452W-1	
	12	8	50	1.00	502-453-1	502-453W-1	
	12	8	50	1.25	502-454-1	502-454W-1	
	12	8	50	1.50	502-455-1	502-455W-1	
	12	8	50	2.00	502-456-1	502-456W-1	
	12	8	50	3.00	502-457-1	502-457W-1	
	19	8	63	0.50	500-471-1	500-471W-1	
	19	8	63	0.75	500-472-1	500-472W-1	
	19	8	63	1.00	500-473-1	500-473W-1	
	19	8	63	1.25	500-474-1	500-474W-1	
	19	8	63	1.50	500-475-1	500-475W-1	
	19	8	63	2.00	500-476-1	500-476W-1	
	19	8	63	3.00	500-477-1	500-477W-1	
	25	8	75	0.50	501-441-1	501-441W-1	
25	8	75	0.75	501-442-1	501-442W-1		
25	8	75	1.00	501-443-1	501-443W-1		

- Flats are not recommended on shank diameters smaller than 8mm.
- 不建议在直径小于8mm的刀柄上使用平面。

V4 CORNER RADIUS ENDMILLS

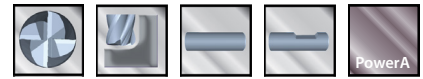

V4倒R角刀铣刀



Length Key (K)

■ Stub
 ■ Standard
 ■ Long

Quick Ship Items

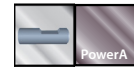
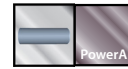

K	OD	LOC	SHK	OAL	Radius	PowerA	
	D1	L1	D2	L2	R	No Flat	With Flat
8	25	8	75	1.25	501-444-1	501-444W-1	
	25	8	75	1.50	501-445-1	501-445W-1	
	25	8	75	2.00	501-446-1	501-446W-1	
	25	8	75	3.00	501-447-1	501-447W-1	
10	14	10	50	0.50	502-461-1	502-461W-1	
	14	10	50	0.75	502-462-1	502-462W-1	
	14	10	50	1.00	502-463-1	502-463W-1	
	14	10	50	1.25	502-464-1	502-464W-1	
	14	10	50	1.50	502-465-1	502-465W-1	
	14	10	50	2.00	502-466-1	502-466W-1	
	14	10	50	3.00	502-467-1	502-467W-1	
	22	10	70	0.50	500-481-1	500-481W-1	
	22	10	70	0.75	500-482-1	500-482W-1	
	22	10	70	1.00	500-483-1	500-483W-1	
	22	10	70	1.25	500-484-1	500-484W-1	
	22	10	70	1.50	500-485-1	500-485W-1	
	22	10	70	2.00	500-486-1	500-486W-1	
	22	10	70	3.00	500-487-1	500-487W-1	
	38	10	100	0.50	501-451-1	501-451W-1	
	38	10	100	0.75	501-452-1	501-452W-1	
38	10	100	1.00	501-453-1	501-453W-1		
38	10	100	1.25	501-454-1	501-454W-1		
38	10	100	1.50	501-455-1	501-455W-1		
38	10	100	2.00	501-456-1	501-456W-1		
38	10	100	3.00	501-457-1	501-457W-1		
12	16	12	63	0.50	502-471-1	502-471W-1	
	16	12	63	0.75	502-472-1	502-472W-1	
	16	12	63	1.00	502-473-1	502-473W-1	
	16	12	63	1.25	502-474-1	502-474W-1	
	16	12	63	1.50	502-475-1	502-475W-1	
	16	12	63	2.00	502-476-1	502-476W-1	
	16	12	63	3.00	502-477-1	502-477W-1	
	16	12	63	4.00	502-478-1	502-478W-1	
	25	12	75	0.50	500-491-1	500-491W-1	

- Flats are not recommended on shank diameters smaller than 8mm.
- 不建议在直径小于8mm的刀柄上使用平面。

V4 CORNER RADIUS ENDMILLS

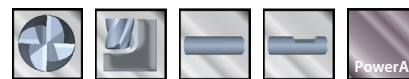

V4倒R角刀铣刀



Length Key (K)

■ Stub
 ■ Standard
 ■ Long

Quick Ship Items



K	OD	LOC	SHK	OAL	Radius	PowerA	
	D1	L1	D2	L2	R	No Flat	With Flat
12	25	12	75	12	0.75	500-492-1	500-492W-1
					1.00	500-493-1	500-493W-1
					1.25	500-494-1	500-494W-1
					1.50	500-495-1	500-495W-1
					2.00	500-496-1	500-496W-1
					3.00	500-497-1	500-497W-1
					4.00	500-498-1	500-498W-1
	50	12	100	0.50	501-461-1	501-461W-1	
				0.75	501-462-1	501-462W-1	
				1.00	501-463-1	501-463W-1	
				1.25	501-464-1	501-464W-1	
				1.50	501-465-1	501-465W-1	
				2.00	501-466-1	501-466W-1	
				3.00	501-467-1	501-467W-1	
4.00	501-468-1	501-468W-1					
14	25	14	88	0.50	500-501-1	500-501W-1	
				0.75	500-502-1	500-502W-1	
				1.00	500-503-1	500-503W-1	
				1.50	500-505-1	500-505W-1	
				2.00	500-506-1	500-506W-1	
				3.00	500-507-1	500-507W-1	
				4.00	500-508-1	500-508W-1	
	56	14	125	0.50	501-471-1	501-471W-1	
				0.75	501-472-1	501-472W-1	
				1.00	501-473-1	501-473W-1	
				1.50	501-475-1	501-475W-1	
				2.00	501-476-1	501-476W-1	
				3.00	501-477-1	501-477W-1	
				4.00	501-478-1	501-478W-1	
16	32	16	88	0.50	500-511-1	500-511W-1	
				0.75	500-512-1	500-512W-1	
				1.00	500-513-1	500-513W-1	
				1.50	500-515-1	500-515W-1	
				2.00	500-516-1	500-516W-1	

- Flats are not recommended on shank diameters smaller than 8mm.
- 不建议在直径小于8mm的刀柄上使用平面。

V4 CORNER RADIUS ENDMILLS



V4倒R角刀铣刀



Length Key (K)

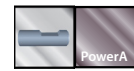
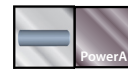

Quick Ship Items

K	OD	LOC	SHK	OAL	Radius	PowerA																																						
						No Flat	With Flat																																					
	D1	L1	D2	L2	R																																							
16	32	16	88	3.00	500-517-1	500-517W-1	500-518-1	500-518W-1																																				
									32	16	88	4.00	501-481-1	501-481W-1																														
															56	16	150	0.50	501-482-1	501-482W-1																								
																					56	16	150	0.75	501-483-1	501-483W-1																		
																											56	16	150	1.00	501-485-1	501-485W-1												
																																	56	16	150	1.50	501-486-1	501-486W-1						
																																							56	16	150	2.00	501-487-1	501-487W-1
56	16	150	4.00	500-521-1	500-521W-1																																							
						36	18	100	0.75	500-522-1	500-522W-1																																	
												36	18	100	1.00	500-523-1	500-523W-1																											
																		36	18	100	1.50	500-525-1	500-525W-1																					
																								36	18	100	2.00	500-526-1	500-526W-1															
																														36	18	100	3.00	500-527-1	500-527W-1									
																																				36	18	100	4.00	500-528-1	500-528W-1			
																																										56	18	150
56	18	150	0.75	501-492-1	501-492W-1																																							
						56	18	150	1.00	501-493-1	501-493W-1																																	
												56	18	150	1.50	501-495-1	501-495W-1																											
																		56	18	150	2.00	501-496-1	501-496W-1																					
																								56	18	150	3.00	501-497-1	501-497W-1															
																														56	18	150	4.00	501-498-1	501-498W-1									
																																				38	20	100	0.50	500-531-1	500-531W-1			
																																										38	20	100
38	20	100	1.00	500-533-1	500-533W-1																																							
						38	20	100	1.50	500-535-1	500-535W-1																																	
												38	20	100	2.00	500-536-1	500-536W-1																											
																		38	20	100	3.00	500-537-1	500-537W-1																					
																								38	20	100	4.00	500-538-1	500-538W-1															
																														38	20	100	5.00	501-501-1	501-501W-1									
																																				56	20	150	0.50	501-502-1	501-502W-1			
																																										56	20	150
56	20	150	1.00																																									

- Flats are not recommended on shank diameters smaller than 8mm.
- 不建议在直径小于8mm的刀柄上使用平面。

V4 CORNER RADIUS ENDMILLS

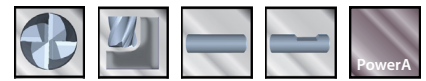

V4倒R角刀铣刀



Length Key (K)

■ Stub
 ■ Standard
 ■ Long

Quick Ship Items



K	OD	LOC	SHK	OAL	Radius	PowerA	
	D1	L1	D2	L2	R	No Flat	With Flat
20	56	20	150	1.50	501-505-1	501-505W-1	
		20	150	2.00	501-506-1	501-506W-1	
		20	150	3.00	501-507-1	501-507W-1	
		20	150	4.00	501-508-1	501-508W-1	
		20	150	5.00	501-509-1	501-509W-1	
25	38	25	100	0.50	500-541-1	500-541W-1	
		25	100	0.75	500-542-1	500-542W-1	
		25	100	1.00	500-543-1	500-543W-1	
		25	100	1.50	500-545-1	500-545W-1	
		25	100	2.00	500-546-1	500-546W-1	
		25	100	3.00	500-547-1	500-547W-1	
		25	100	4.00	500-548-1	500-548W-1	
		25	100	5.00	500-549-1	500-549W-1	
	70	25	150	0.50	501-511-1	501-511W-1	
		25	150	0.75	501-512-1	501-512W-1	
		25	150	1.00	501-513-1	501-513W-1	
		25	150	1.50	501-515-1	501-515W-1	
		25	150	2.00	501-516-1	501-516W-1	
		25	150	3.00	501-517-1	501-517W-1	
		25	150	4.00	501-518-1	501-518W-1	
		25	150	5.00	501-519-1	501-519W-1	

- Flats are not recommended on shank diameters smaller than 8mm.
- 不建议在直径小于8mm的刀柄上使用平面。

V5 SQUARE ENDMILLS

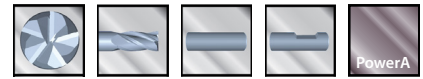

V5平底铣刀

HIGH PERFORMANCE ENDMILLS

5 Flutes 5刃	Coated with or without flat 涂层, 普通刀杆和侧固刀杆	Quiet operation and better finish 运行安静和更好的表面光洁度
----------------	--	--

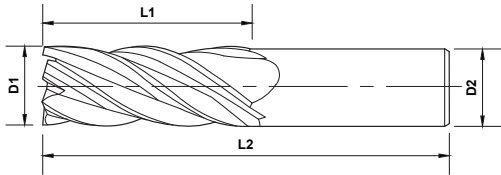

PowerA



Length Key (K)



PowerA



PowerA

Quick Ship Items

	OD	LOC	SHK	OAL	PowerA	
	D1	L1	D2	L2	No Flat	With Flat
8		12	8	50	510-010-1	510-010W-1
		19	8	63	508-010-1	508-010W-1
		25	8	75	509-010-1	509-010W-1
10		14	10	50	510-012-1	510-012W-1
		22	10	70	508-012-1	508-012W-1
		38	10	100	509-012-1	509-012W-1
12		16	12	63	510-014-1	510-014W-1
		25	12	75	508-014-1	508-014W-1
		50	12	100	509-014-1	509-014W-1
14		25	14	88	508-016-1	508-016W-1
		56	14	125	509-016-1	509-016W-1
16		32	16	88	508-018-1	508-018W-1
		56	16	150	509-018-1	509-018W-1
18		36	18	100	508-020-1	508-020W-1
		56	18	150	509-020-1	509-020W-1
20		38	20	100	508-022-1	508-022W-1
		56	20	150	509-022-1	509-022W-1
25		38	25	100	508-024-1	508-024W-1
		70	25	150	509-024-1	509-024W-1

- Flats are not recommended on shank diameters smaller than 8mm.
- 不建议在直径小于8mm的刀柄上使用平面。

V5 BALL ENDMILLS

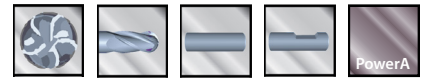

V5球头铣刀

5 Flutes 5刃	Coated with or without flat 涂层, 普通刀杆和侧固刀杆	Quiet operation and better finish 运行安静和更好的表面光洁度
----------------	--	--

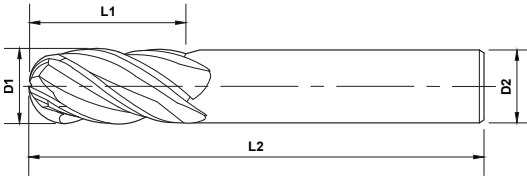

PowerA



Length Key (K)



Quick Ship Items

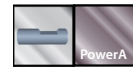

	OD	LOC	SHK	OAL	PowerA	
					No Flat	With Flat
	D1	L1	D2	L2		
8		12	8	50	510-210-1	510-210W-1
		19	8	63	508-210-1	508-210W-1
		25	8	75	509-210-1	509-210W-1
10		14	10	50	510-212-1	510-212W-1
		22	10	70	508-212-1	508-212W-1
		38	10	100	509-212-1	509-212W-1
12		16	12	63	510-214-1	510-214W-1
		25	12	75	508-214-1	508-214W-1
		50	12	100	509-214-1	509-214W-1
14		25	14	88	508-216-1	508-216W-1
		56	14	125	509-216-1	509-216W-1
16		32	16	88	508-218-1	508-218W-1
		56	16	150	509-218-1	509-218W-1
18		36	18	100	508-220-1	508-220W-1
		56	18	150	509-220-1	509-220W-1
20		38	20	100	508-222-1	508-222W-1
		56	20	150	509-222-1	509-222W-1
25		38	25	100	508-224-1	508-224W-1
		70	25	150	509-224-1	509-224W-1

- Flats are not recommended on shank diameters smaller than 8mm.
- 不建议在直径小于8mm的刀柄上使用平面。

V5 CORNER RADIUS ENDMILLS

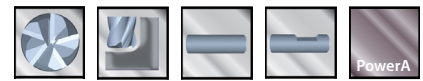

V5 倒R角铣刀

HIGH PERFORMANCE ENDMILLS

5 Flutes 5刃	Coated with or without flat 涂层, 普通刀杆和侧固刀杆	Quiet operation and better finish 运行安静和更好的表面光洁度
----------------	--	--

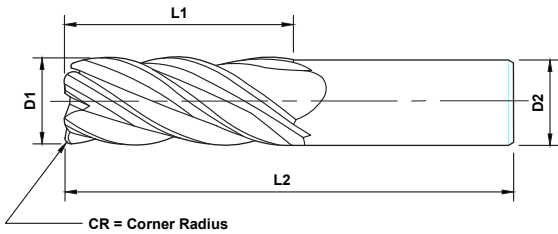

PowerA



Length Key (K)



Quick Ship Items

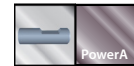

	OD	LOC	SHK	OAL	Radius	PowerA	
	D1	L1	D2	L2	R	No Flat	With Flat
6	6	15	6	75	0.50	509-431-1	509-431W-1
		12	8	50	0.50	510-441-1	510-441W-1
8	8	19	8	63	0.50	508-441-1	508-441W-1
		25	8	75	0.50	509-441-1	509-441W-1
		14	10	50	0.50	510-451-1	510-451W-1
10	10	22	10	70	0.50	508-451-1	508-451W-1
		38	10	100	0.50	509-451-1	509-451W-1
		16	12	63	0.75	510-462-1	510-462W-1
12	12	25	12	75	0.75	508-462-1	508-462W-1
		50	12	100	0.75	509-462-1	509-462W-1
		25	14	88	0.75	508-472-1	508-472W-1
14	14	56	14	125	0.75	509-472-1	509-472W-1
		32	16	88	0.75	508-482-1	508-482W-1
16	16	56	16	150	0.75	509-482-1	509-482W-1
		36	18	100	0.75	508-492-1	508-492W-1
18	18	56	18	150	0.75	509-492-1	509-492W-1
		38	20	100	0.75	508-502-1	508-502W-1
20	20	56	20	150	0.75	509-502-1	509-502W-1
		38	25	100	0.75	508-512-1	508-512W-1
25	25	70	25	150	0.75	509-512-1	509-512W-1

- Flats are not recommended on shank diameters smaller than 8mm.
- 不建议在直径小于8mm的刀柄上使用平面。

HY5 SQUARE ENDMILLS

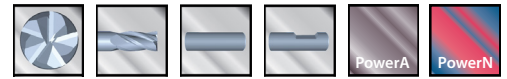

HY5 平底铣刀

5 Flutes	Coated with or without flat	Unique 5 flute design for faster speeds and feeds
5刃	涂层, 普通刀杆和侧固刀杆	独自の5枚刃構造により切削速度と送り速度が向上

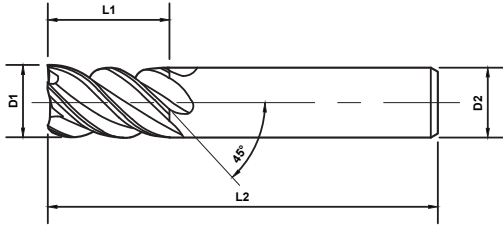

Length Key (K)



Quick Ship Items

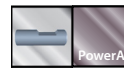
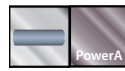

OD	LOC	SHK	OAL	PowerA		PowerNR	
				No Flat	With Flat	No Flat	With Flat
3	6	3	38	547-002-1	547-002W-1	547-002-8	547-002W-8
	12	3	38	545-002-1	545-002W-1	545-002-8	545-002W-8
	20	3	65	546-002-1	546-002W-1	546-002-8	546-002W-8
4	8	4	50	547-004-1	547-004W-1	547-004-8	547-004W-8
	14	4	50	545-008-1	545-008W-1	545-008-8	545-008W-8
	20	4	65	546-004-1	546-004W-1	546-004-8	546-004W-8
5	10	5	50	547-006-1	547-006W-1	547-006-8	547-006W-8
	16	5	50	545-014-1	545-014W-1	545-014-8	545-014W-8
	20	5	75	546-006-1	546-006W-1	546-006-8	546-006W-8
6	12	6	50	547-008-1	547-008W-1	547-008-8	547-008W-8
	19	6	63	545-018-1	545-018W-1	545-018-8	545-018W-8
	25	6	75	546-008-1	546-008W-1	546-008-8	546-008W-8
8	12	8	50	547-012-1	547-012W-1	547-012-8	547-012W-8
	19	8	63	545-020-1	545-020W-1	545-020-8	545-020W-8
	25	8	75	546-010-1	546-010W-1	546-010-8	546-010W-8
10	14	10	50	547-014-1	547-014W-1	547-014-8	547-014W-8
	22	10	70	545-022-1	545-022W-1	545-022-8	545-022W-8
	38	10	100	546-012-1	546-012W-1	546-012-8	546-012W-8
12	16	12	63	547-016-1	547-016W-1	547-016-8	547-016W-8
	25	12	75	545-024-1	545-024W-1	545-024-8	545-024W-8
	50	12	100	546-014-1	546-014W-1	546-014-8	546-014W-8
14	25	14	88	545-026-1	545-026W-1	545-026-8	545-026W-8
	56	14	125	546-016-1	546-016W-1	546-016-8	546-016W-8
16	32	16	88	545-028-1	545-028W-1	545-028-8	545-028W-8
	56	16	150	546-018-1	546-018W-1	546-018-8	546-018W-8
18	36	18	100	545-030-1	545-030W-1	545-030-8	545-030W-8
	56	18	150	546-020-1	546-020W-1	546-020-8	546-020W-8
20	38	20	100	545-032-1	545-032W-1	545-032-8	545-032W-8
	56	20	150	546-022-1	546-022W-1	546-022-8	546-022W-8
25	38	25	100	545-034-1	545-034W-1	545-034-8	545-034W-8
	70	25	150	546-024-1	546-024W-1	546-024-8	546-024W-8

- Flats are not recommended on shank diameters smaller than 8mm.
- 不建议在直径小于8mm的刀柄上使用平面。

HY5 CORNER RADIUS ENDMILLS

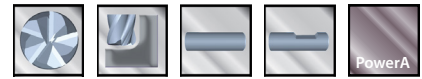

HY5 倒R角铣刀

HIGH PERFORMANCE ENDMILLS

5 Flutes 5刃	Coated with or without flat 涂层, 普通刀杆和侧固刀杆	Unique 5 flute design for faster speeds and feeds 独到的5刃设计适合更高转速和进给
----------------	--	---

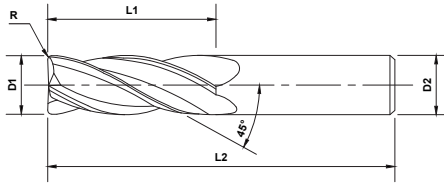

Length Key (K)

Stub Standard Long



	OD	LOC	SHK	OAL	Radius	PowerA	
	D1	L1	D2	L2	R	No Flat	With Flat
3	6	3	38	38	0.25	547-401-1	547-401W-1
					0.50	547-402-1	547-402W-1
					0.75	547-403-1	547-403W-1
					1.00	547-404-1	547-404W-1
	12	3	38	38	0.25	545-400-1	545-400W-1
					0.50	545-401-1	545-401W-1
					0.75	545-402-1	545-402W-1
					1.00	545-403-1	545-403W-1
	20	3	65	65	0.25	546-400-1	546-400W-1
					0.50	546-401-1	546-401W-1
					0.75	546-402-1	546-402W-1
					1.00	546-403-1	546-403W-1
4	8	4	50	50	0.25	547-410-1	547-410W-1
					0.50	547-411-1	547-411W-1
					0.75	547-412-1	547-412W-1
					1.00	547-413-1	547-413W-1
	14	4	50	50	0.25	545-420-1	545-420W-1
					0.50	545-421-1	545-421W-1
					0.75	545-422-1	545-422W-1
					1.00	545-423-1	545-423W-1
	20	4	65	65	0.25	546-410-1	546-410W-1
					0.50	546-411-1	546-411W-1
					0.75	546-412-1	546-412W-1
					1.00	546-413-1	546-413W-1
5	10	5	50	0.25	547-420-1	547-420W-1	
				0.50	547-421-1	547-421W-1	
				0.75	547-422-1	547-422W-1	

- Flats are not recommended on shank diameters smaller than 8mm.
- 不建议在直径小于8mm的刀柄上使用平面。

HY5 CORNER RADIUS ENDMILLS

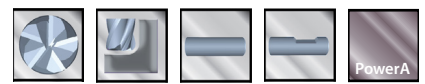

HY5 倒R角铣刀

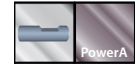

OD	LOC	SHK	OAL	Radius	PowerA	
					No Flat	With Flat
D1	L1	D2	L2	R		
5	10	5	50	1.00	547-423-1	547-423W-1
	16	5	50	0.25	545-440-1	545-440W-1
	16	5	50	0.50	545-441-1	545-441W-1
	16	5	50	0.75	545-442-1	545-442W-1
	16	5	50	1.00	545-443-1	545-443W-1
	20	5	75	0.25	546-420-1	546-420W-1
	20	5	75	0.50	546-422-1	546-422W-1
	20	5	75	0.75	546-423-1	546-423W-1
	20	5	75	1.00	546-424-1	546-424W-1
6	12	6	50	0.25	547-430-1	547-430W-1
	12	6	50	0.50	547-431-1	547-431W-1
	12	6	50	0.75	547-432-1	547-432W-1
	12	6	50	1.00	547-433-1	547-433W-1
	12	6	50	1.25	547-434-1	547-434W-1
	12	6	50	1.50	547-435-1	547-435W-1
	12	6	50	2.00	547-436-1	547-436W-1
	19	6	63	0.25	545-460-1	545-460W-1
	19	6	63	0.50	545-461-1	545-461W-1
	19	6	63	0.75	545-462-1	545-462W-1
	19	6	63	1.00	545-463-1	545-463W-1
	19	6	63	1.25	545-464-1	545-464W-1
	19	6	63	1.50	545-465-1	545-465W-1
	19	6	63	2.00	545-466-1	545-466W-1
	25	6	75	0.25	546-430-1	546-430W-1
	25	6	75	0.50	546-431-1	546-431W-1
	25	6	75	0.75	546-432-1	546-432W-1
	25	6	75	1.00	546-433-1	546-433W-1
	25	6	75	1.25	546-434-1	546-434W-1
	25	6	75	1.50	546-435-1	546-435W-1
25	6	75	2.00	546-436-1	546-436W-1	
8	12	8	50	0.50	547-451-1	547-451W-1
	12	8	50	0.75	547-452-1	547-452W-1
	12	8	50	1.00	547-453-1	547-453W-1
	12	8	50	1.25	547-454-1	547-454W-1
	12	8	50	1.50	547-455-1	547-455W-1
	12	8	50	2.00	547-456-1	547-456W-1
	12	8	50	3.00	547-457-1	547-457W-1
	19	8	63	0.50	545-471-1	545-471W-1
	19	8	63	0.75	545-472-1	545-472W-1
	19	8	63	1.00	545-473-1	545-473W-1
	19	8	63	1.25	545-474-1	545-474W-1
	19	8	63	1.50	545-475-1	545-475W-1
	19	8	63	2.00	545-476-1	545-476W-1
	19	8	63	3.00	545-477-1	545-477W-1

- Flats are not recommended on shank diameters smaller than 8mm.
- 不建议在直径小于8mm的刀柄上使用平面。

HY5 CORNER RADIUS ENDMILLS

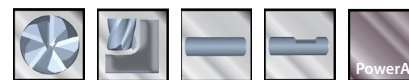

HY5 倒R角铣刀



HIGH PERFORMANCE ENDMILLS

OD	LOC	SHK	OAL	Radius	PowerA	
D1	L1	D2	L2	R	No Flat	With Flat
8	25	8	75	0.50	546-441-1	546-441W-1
	25	8	75	0.75	546-442-1	546-442W-1
	25	8	75	1.00	546-443-1	546-443W-1
	25	8	75	1.25	546-444-1	546-444W-1
	25	8	75	1.50	546-445-1	546-445W-1
	25	8	75	2.00	546-446-1	546-446W-1
	25	8	75	3.00	546-447-1	546-447W-1
10	14	10	50	0.50	547-461-1	547-461W-1
	14	10	50	0.75	547-462-1	547-462W-1
	14	10	50	1.00	547-463-1	547-463W-1
	14	10	50	1.25	547-464-1	547-464W-1
	14	10	50	1.50	547-465-1	547-465W-1
	14	10	50	2.00	547-466-1	547-466W-1
	14	10	50	3.00	547-467-1	547-467W-1
	22	10	70	0.50	545-481-1	545-481W-1
	22	10	70	0.75	545-482-1	545-482W-1
	22	10	70	1.00	545-483-1	545-483W-1
	22	10	70	1.25	545-484-1	545-484W-1
	22	10	70	1.50	545-485-1	545-485W-1
	22	10	70	2.00	545-486-1	545-486W-1
	22	10	70	3.00	545-487-1	545-487W-1
	38	10	100	0.50	546-451-1	546-451W-1
	38	10	100	0.75	546-452-1	546-452W-1
	38	10	100	1.00	546-453-1	546-453W-1
38	10	100	1.25	546-454-1	546-454W-1	
38	10	100	1.50	546-455-1	546-455W-1	
38	10	100	2.00	546-456-1	546-456W-1	
38	10	100	3.00	546-457-1	546-457W-1	
12	16	12	63	0.50	547-471-1	547-471W-1
	16	12	63	0.75	547-472-1	547-472W-1
	16	12	63	1.00	547-473-1	547-473W-1
	16	12	63	1.25	547-474-1	547-474W-1
	16	12	63	1.50	547-475-1	547-475W-1
	16	12	63	2.00	547-476-1	547-476W-1
	16	12	63	3.00	547-477-1	547-477W-1
	16	12	63	4.00	547-478-1	547-478W-1
	25	12	75	0.50	545-491-1	545-491W-1
	25	12	75	0.75	545-492-1	545-492W-1
	25	12	75	1.00	545-493-1	545-493W-1
	25	12	75	1.25	545-494-1	545-494W-1
	25	12	75	1.50	545-495-1	545-495W-1
	25	12	75	2.00	545-496-1	545-496W-1
	25	12	75	3.00	545-497-1	545-497W-1
	25	12	75	4.00	545-498-1	545-498W-1

- Flats are not recommended on shank diameters smaller than 8mm.
- 不建议在直径小于8mm的刀柄上使用平面。

HY5 CORNER RADIUS ENDMILLS

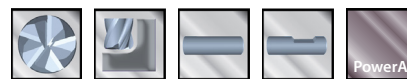

HY5 倒R角铣刀



	OD	LOC	SHK	OAL	Radius	PowerA	
	D1	L1	D2	L2	R	No Flat	With Flat
12		50	12	100	0.50	546-461-1	546-461W-1
		50	12	100	0.75	546-462-1	546-462W-1
		50	12	100	1.00	546-463-1	546-463W-1
		50	12	100	1.25	546-464-1	546-464W-1
		50	12	100	1.50	546-465-1	546-465W-1
		50	12	100	2.00	546-466-1	546-466W-1
		50	12	100	3.00	546-467-1	546-467W-1
		50	12	100	4.00	546-468-1	546-468W-1
14		25	14	88	0.50	545-501-1	545-501W-1
		25	14	88	0.75	545-502-1	545-502W-1
		25	14	88	1.00	545-503-1	545-503W-1
		25	14	88	1.50	545-505-1	545-505W-1
		25	14	88	2.00	545-506-1	545-506W-1
		25	14	88	3.00	545-507-1	545-507W-1
		25	14	88	4.00	545-508-1	545-508W-1
		56	14	125	0.50	546-471-1	546-471W-1
		56	14	125	0.75	546-472-1	546-472W-1
		56	14	125	1.00	546-473-1	546-473W-1
		56	14	125	1.50	546-475-1	546-475W-1
		56	14	125	2.00	546-476-1	546-476W-1
		56	14	125	3.00	546-477-1	546-477W-1
		56	14	125	4.00	546-478-1	546-478W-1
16		32	16	88	0.50	545-511-1	545-511W-1
		32	16	88	0.75	545-512-1	545-512W-1
		32	16	88	1.00	545-513-1	545-513W-1
		32	16	88	1.50	545-515-1	545-515W-1
		32	16	88	2.00	545-516-1	545-516W-1
		32	16	88	3.00	545-517-1	545-517W-1
		32	16	88	4.00	545-518-1	545-518W-1
		56	16	150	0.50	546-481-1	546-481W-1
		56	16	150	0.75	546-482-1	546-482W-1
		56	16	150	1.00	546-483-1	546-483W-1
		56	16	150	1.50	546-485-1	546-485W-1
		56	16	150	2.00	546-486-1	546-486W-1
		56	16	150	3.00	546-487-1	546-487W-1
		56	16	150	4.00	546-488-1	546-488W-1
18		36	18	100	0.50	545-521-1	545-521W-1
		36	18	100	0.75	545-522-1	545-522W-1
		36	18	100	1.00	545-523-1	545-523W-1
		36	18	100	1.50	545-525-1	545-525W-1
		36	18	100	2.00	545-526-1	545-526W-1
		36	18	100	3.00	545-527-1	545-527W-1
		36	18	100	4.00	545-528-1	545-528W-1
		56	18	150	0.50	546-491-1	546-491W-1

- Flats are not recommended on shank diameters smaller than 8mm.
- 不建议在直径小于8mm的刀柄上使用平面。

HY5 CORNER RADIUS ENDMILLS

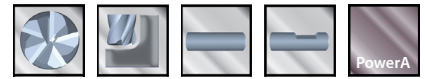

HY5 倒R角铣刀



HIGH PERFORMANCE ENDMILLS



OD	LOC	SHK	OAL	Radius	PowerA	
					No Flat	With Flat
D1	L1	D2	L2	R		
18	56	18	150	0.75	546-492-1	546-492W-1
	56	18	150	1.00	546-493-1	546-493W-1
	56	18	150	1.50	546-495-1	546-495W-1
	56	18	150	2.00	546-496-1	546-496W-1
	56	18	150	3.00	546-497-1	546-497W-1
	56	18	150	4.00	546-498-1	546-498W-1
20	38	20	100	0.50	545-531-1	545-531W-1
	38	20	100	0.75	545-532-1	545-532W-1
	38	20	100	1.00	545-533-1	545-533W-1
	38	20	100	1.50	545-535-1	545-535W-1
	38	20	100	2.00	545-536-1	545-536W-1
	38	20	100	3.00	545-537-1	545-537W-1
	38	20	100	4.00	545-538-1	545-538W-1
	38	20	100	5.00	545-539-1	545-539W-1
	56	20	150	0.50	546-501-1	546-501W-1
	56	20	150	0.75	546-502-1	546-502W-1
	56	20	150	1.00	546-503-1	546-503W-1
	56	20	150	1.50	546-505-1	546-505W-1
	56	20	150	2.00	546-506-1	546-506W-1
	56	20	150	3.00	546-507-1	546-507W-1
56	20	150	4.00	546-508-1	546-508W-1	
56	20	150	5.00	546-509-1	546-509W-1	
25	38	25	100	0.50	545-541-1	545-541W-1
	38	25	100	0.75	545-542-1	545-542W-1
	38	25	100	1.00	545-543-1	545-543W-1
	38	25	100	1.50	545-545-1	545-545W-1
	38	25	100	2.00	545-546-1	545-546W-1
	38	25	100	3.00	545-547-1	545-547W-1
	38	25	100	4.00	545-548-1	545-548W-1
	38	25	100	5.00	545-549-1	545-549W-1
	70	25	150	0.50	546-511-1	546-511W-1
	70	25	150	0.75	546-512-1	546-512W-1
	70	25	150	1.00	546-513-1	546-513W-1
	70	25	150	1.50	546-515-1	546-515W-1
	70	25	150	2.00	546-516-1	546-516W-1
	70	25	150	3.00	546-517-1	546-517W-1
70	25	150	4.00	546-518-1	546-518W-1	
70	25	150	5.00	546-519-1	546-519W-1	

- Flats are not recommended on shank diameters smaller than 8mm.
- 不建议在直径小于8mm的刀柄上使用平面。

F45 6FL SQUARE ENDMILLS

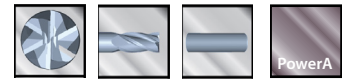

F45, 6刃平底铣刀

6 Flutes	coated and uncoated	45° 6 flute design for superior finish
6刃	涂层 & 无涂层	45°, 六刃设计为获得优异的表面光洁度

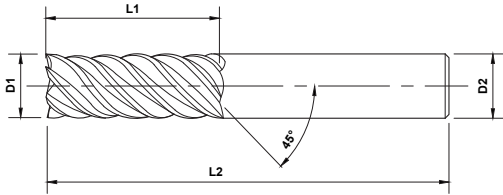

Uncoated



PowerA



Length Key (K)



Quick Ship Items



OD		LOC	SHK	OAL		Uncoated	PowerA
D1	L1	D2	L2				
5	16	5	50	511-002		511-002-1	
6	19	6	63	511-004		511-004-1	
7	19	8	63	511-006		511-006-1	
8	21	8	63	511-008		511-008-1	
9	22	10	70	511-010		511-010-1	
10	25	10	70	511-012		511-012-1	
11	25	11	70	511-014		511-014-1	
12	25	12	75	511-016		511-016-1	
14	30	14	88	511-018		511-018-1	
16	32	16	88	511-020		511-020-1	
18	35	18	100	511-022		511-022-1	
20	38	20	100	511-024		511-024-1	
22	38	22	100	511-026		511-026-1	
25	38	25	100	511-028		511-028-1	

F45 6FL CORNER RADIUS ENDMILLS

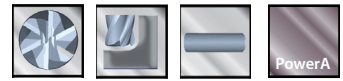

F45, 6刃倒R角铣刀

HIGH PERFORMANCE ENDMILLS

6 Flutes	coated and uncoated	45° 6 flute design for superior finish
6刃	涂层 & 无涂层	45°, 六刃设计为获得优异的表面光洁度

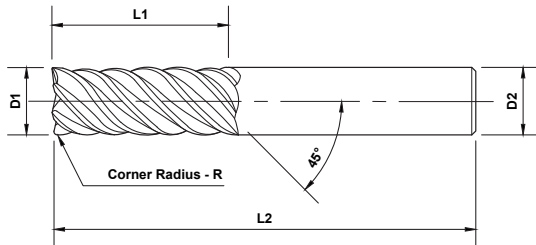

Uncoated



PowerA

Length Key (K)

■ Stub
 ■ Standard
 ■ Long



OD	LOC	SHK	OAL	Radius	Uncoated	PowerA
D1	L1	D2	L2	R		
5	16	5	50	0.25	511-200	511-200-1
6	19	6	63	0.25	511-210	511-210-1
7	19	8	63	0.25	511-220	511-220-1
8	21	8	63	0.25	511-230	511-230-1
9	22	10	70	0.50	511-241	511-241-1
10	25	10	70	0.50	511-251	511-251-1
11	25	11	70	0.50	511-261	511-261-1
12	25	12	75	0.50	511-271	511-271-1
14	30	14	88	0.50	511-281	511-281-1
16	32	16	88	0.50	511-291	511-291-1
18	35	18	100	1.00	511-303	511-303-1
20	38	20	100	1.00	511-313	511-313-1
22	38	22	100	1.00	511-323	511-323-1
25	38	25	100	1.25	511-334	511-334-1

MOLD MILLS BALL NECKED

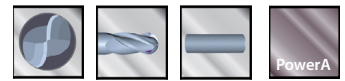

球头缩颈模具铣刀

2 Flutes 2刃	coated and uncoated 涂层 & 无涂层	Superb quality for mold and die operation 优异的品质适用于模具加工
----------------	---------------------------------	---

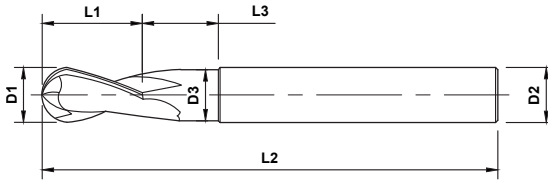

Uncoated

Length Key (K)

■ Stub
 ■ Standard
 ■ Long



	OD	LOC	SHK	OAL	Neck OD	NeckLength	Uncoated	PowerA
	D1	L1	D2	L2	D3	L3		
	1.0	1.2	3	50	0.95	3	542-002	542-002-1
	1.2	1.8	3	50	1.45	4.5	542-004	542-004-1
	2.0	2.4	3	50	1.95	6	542-006	542-006-1
	2.5	3	3	50	2.45	7.5	542-008	542-008-1
	3.0	3.6	3	50	2.95	9	542-010	542-010-1

BALL NECKED EXTENDED REACH MOLD MILLS

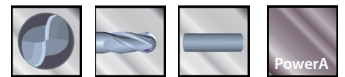

加长缩颈系列

Length Key (K)

■ Stub
 ■ Standard
 ■ Long



	OD	LOC	SHK	OAL	Neck OD	Neck Length	Uncoated	PowerA
	D1	L1	D2	L2	D3	L3		
	1	1.2	3	50	0.95	5	542-102	542-102-1
	1.2	1.4	3	50	1.15	6	542-104	542-104-1
	1.5	1.8	3	50	1.45	7.5	542-106	542-106-1
	1.8	2.2	3	50	1.75	9	542-108	542-108-1
	2	2.4	3	50	1.95	10	542-110	542-110-1
	2.3	2.8	3	50	2.25	11.5	542-112	542-112-1
	2.5	3	3	50	2.45	12.5	542-114	542-114-1
	2.8	3.4	3	50	2.75	14	542-116	542-116-1
	3	3.6	3	50	2.95	15	542-118	542-118-1

3FL 60° HELIX TWISTERMILL

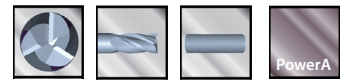

3刃 60°螺旋刃铣刀

HIGH PERFORMANCE ENDMILLS

3 Flutes 3刃	coated and uncoated 涂层 & 无涂层	60° Helix for stainless steels and hi-temp alloys 60°螺旋刃 设计适用于不锈钢和高温合金材料加工
----------------	---------------------------------	---

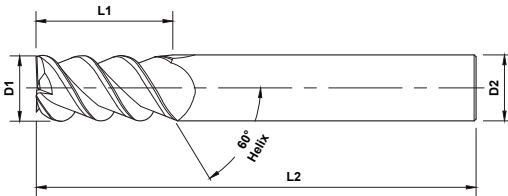

Uncoated

Length Key (K)

■ Stub
 ■ Standard
 ■ Long



	OD	LOC	SHK	OAL	Uncoated	PowerA
	D1	L1	D2	L2		
Standard	6	20	6	63	532-002	532-002-1
	8	22	8	63	532-004	532-004-1
	10	25	10	70	532-006	532-006-1
	12	25	12	75	532-008	532-008-1
	16	30	16	88	532-010	532-010-1
	20	38	20	100	532-012	532-012-1

ROUGHERS - COARSE PITCH

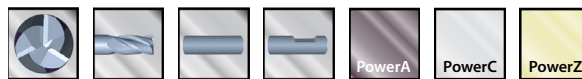

梳齿粗铣刀-粗牙

3 Flutes	coated and uncoated	Rigid design for fast material removal
3刃	涂层 & 无涂层	刚性设计适合快速高效切削

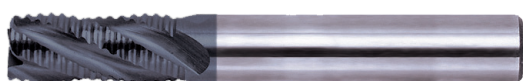
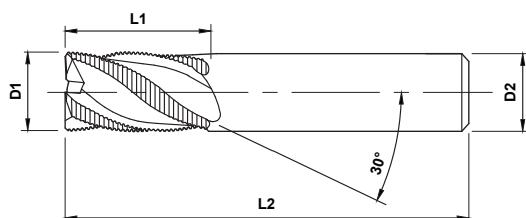

PowerA



PowerZ

Length Key (K)

■ Stub
 ■ Standard
 ■ Long

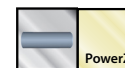

	OD	LOC	SHK	OAL	Flutes	Uncoated	PowerA	PowerC	PowerZ
	D1	L1	D2	L2					
Standard	6	19	6	63	3	533-002	533-002-1	533-002-3	533-002-4
	8	19	8	63	3	533-004	533-004-1	533-004-3	533-004-4
	10	22	10	63	3	533-006	533-006-1	533-006-3	533-006-4
	12	25	12	75	3	-	533-008-1	533-008-3	533-008-4
	16	32	16	88	3	-	533-010-1	533-010-3	533-010-4
	20	38	20	100	3	-	533-012-1	533-012-3	533-012-4
	25	38	25	100	3	-	533-014-1	533-014-3	533-014-4
Long	12	25	12	75	3	533-008W	533-008W-1	533-008W-3	533-008W-4
	16	32	16	88	3	533-010W	533-010W-1	533-010W-3	533-010W-4
	20	38	20	100	3	533-012W	533-012W-1	533-012W-3	533-012W-4
	25	38	25	100	3	533-014W	533-014W-1	533-014W-3	533-014W-4

'W' appended to part numbers indicates this tool is manufactured with a flat on the shank.

"W" 附在零件编号上表示该工具在手柄上制造有平坦表面。

ROUGHERS - FINE PITCH

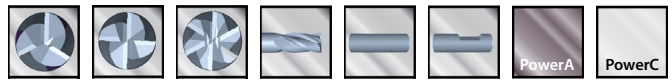

梳齿粗铣刀-细牙

HIGH PERFORMANCE ENDMILLS

3, 4 & 6 Flutes	coated and uncoated	Rigid design for fast material removal
3, 4 & 6刃	涂层 & 无涂层	刚性设计适合快速高效切削

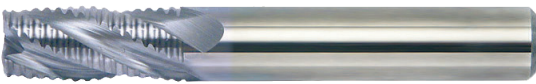
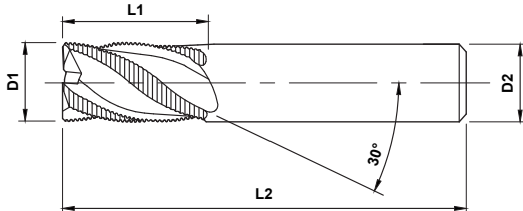

PowerC

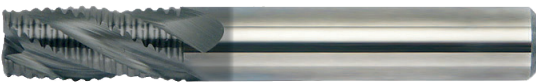

PowerA

Length Key (K)

■ Stub
 ■ Standard
 ■ Long



	OD	LOC	SHK	OAL	Flutes	Uncoated	PowerA	PowerC
	D1	L1	D2	L2				
Standard	6	19	6	63	3	533-102	533-102-1	533-102-3
	8	19	8	63	3	533-104	533-104-1	533-104-3
	10	22	10	63	3	533-106	533-106-1	533-106-3
	12	25	12	75	4	-	533-108-1	533-108-3
	16	32	16	88	4	-	533-110-1	533-110-3
	20	38	20	100	4	-	533-112-1	533-112-3
Long	25	38	25	100	6	-	533-114-1	533-114-3



Long	12	25	12	75	4	533-108W	533-108W-1	533-108W-3
	16	32	16	88	4	533-110W	533-110W-1	533-110W-3
	20	38	20	100	4	533-112W	533-112W-1	533-112W-3
	25	38	25	100	6	533-114W	533-114W-1	533-114W-3

'W' appended to part numbers indicates this tool is manufactured with a flat on the shank.

"W" 附在零件编号上表示该工具在手柄上制造有平坦表面。

ROUGHERS - MEDIUM PITCH

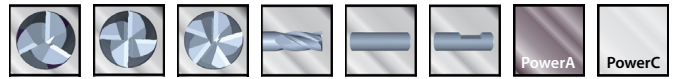

梳齿粗铣刀-中牙

3, 4 & 5 Flutes	coated and uncoated	Rigid design for fast material removal
3, 4 & 5刃	涂层 & 无涂层	刚性设计适合快速高效切削

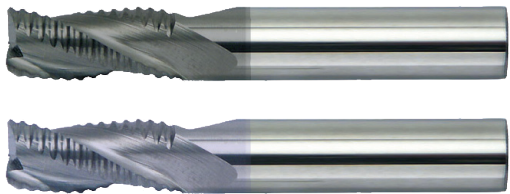
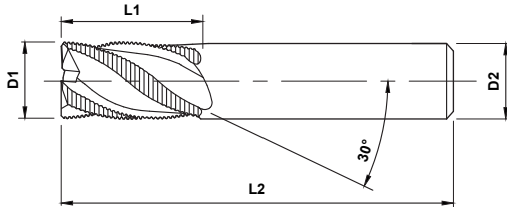

PowerA
PowerC

Length Key (K)

Stub Standard Long



	OD	LOC	SHK	OAL	Flutes	Uncoated	PowerA	PowerC
	D1	L1	D2	L2				
Standard	6	19	6	63	3	533-202	533-202-1	533-202-3
	8	19	8	63	3	533-204	533-204-1	533-204-3
	10	22	10	63	3	533-206	533-206-1	533-206-3
	12	25	12	75	4	-	533-208-1	533-208-3
	16	32	16	88	4	-	533-210-1	533-210-3
	20	38	20	100	4	-	533-212-1	533-212-3
	25	38	25	100	5	-	533-214-1	533-214-3



Long	12	25	12	75	4	533-208W	533-208W-1	533-208W-3
	16	32	16	88	4	533-210W	533-210W-1	533-210W-3
	20	38	20	100	4	533-212W	533-212W-1	533-212W-3
	25	38	25	100	5	533-214W	533-214W-1	533-214W-3

'W' appended to part numbers indicates this tool is manufactured with a flat on the shank.

"W" 附在零件编号上表示该工具在手柄上制造有平坦表面。

SQUARE END AXMILLS

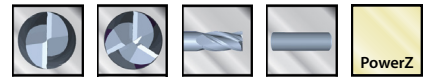

铝合金专用Axmill平底铣刀

HIGH PERFORMANCE ENDMILLS

2 & 3 Flutes	coated and uncoated	Unique flute and relief angles for aluminum	Faster speeds and feeds
2 & 3刃	涂层 & 无涂层	独特的刀刃和后角设计适合铝材加工	更快的转速和进给

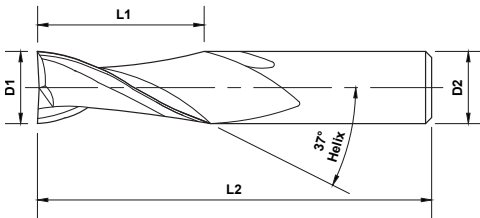

Non-Ferrous
N

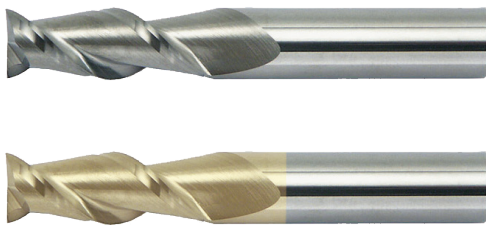

Uncoated
PowerZ



Length Key (K)

Stub
 Standard
 Long

Quick Ship Items



	OD	LOC	SHK	OAL	Uncoated		PowerZ	
					2 Flute	3 Flute	2 Flute	3 Flute
	D1	L1	D2	L2				
	6	19	6	63	514-002	520-002	514-002-4	520-002-4
	8	20	8	63	514-004	520-004	514-004-4	520-004-4
	10	22	10	63	514-006	520-006	514-006-4	520-006-4
	12	25	12	75	514-008	520-008	514-008-4	520-008-4
	16	32	16	88	514-010	520-010	514-010-4	520-010-4
	20	36	20	100	514-012	520-012	514-012-4	520-012-4

CORNER RADIUS AXMILLS

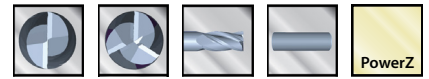

铝合金专用Axmill倒R角铣刀

2 & 3 Flutes	coated and uncoated	Unique flute and relief angles for aluminum	Faster speeds and feeds
2 & 3刃	涂层 & 无涂层	独特的刀刃和后角设计适合铝材加工	更快的转速和进给

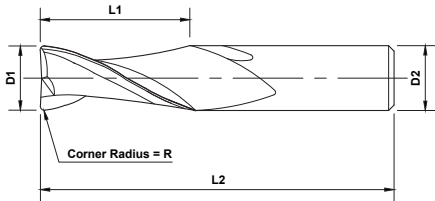

Non-Ferrous
N

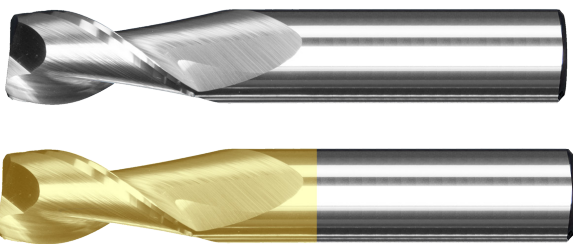

Uncoated
PowerZ



Length Key (K)

■ Stub
 ■ Standard
 ■ Long



	OD	LOC	SHK	OAL	Radius	Uncoated		PowerZ	
						2 Flute	3 Flute	2 Flute	3 Flute
	D1	L1	D2	L2	R				
6		19	6	63	0.50	514-401	520-401	514-401-4	520-401-4
		19	6	63	1.00	514-403	520-403	514-403-4	520-403-4
8		20	8	63	0.50	514-411	520-411	514-411-4	520-411-4
		20	8	63	1.00	514-413	520-413	514-413-4	520-413-4
10		22	10	63	0.50	514-421	520-421	514-421-4	520-421-4
		22	10	63	1.00	514-423	520-423	514-423-4	520-423-4
12		25	12	75	0.50	514-431	520-431	514-431-4	520-431-4
		25	12	75	1.00	514-433	520-433	514-433-4	520-433-4
16		32	16	88	0.50	514-441	520-441	514-441-4	520-441-4
		32	16	88	1.00	514-443	520-443	514-443-4	520-443-4
20		36	20	100	0.50	514-451	520-451	514-451-4	520-451-4
		36	20	100	1.00	514-453	520-453	514-453-4	520-453-4

SQUARE END CHIPBREAKER AXMILLS

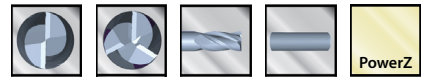

带碎屑刃Axmill 平底铣刀

HIGH PERFORMANCE ENDMILLS

2 & 3 Flutes	coated and uncoated	Unique flute and relief angles for aluminum	Faster speeds and feeds
2 & 3刃	涂层 & 无涂层	独特的刀刃和后角设计适合铝材加工	更快的转速和进给

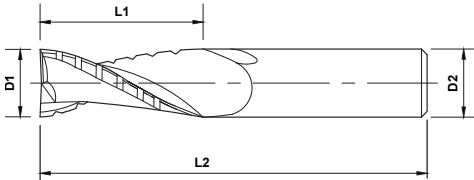

Non-Ferrous
N

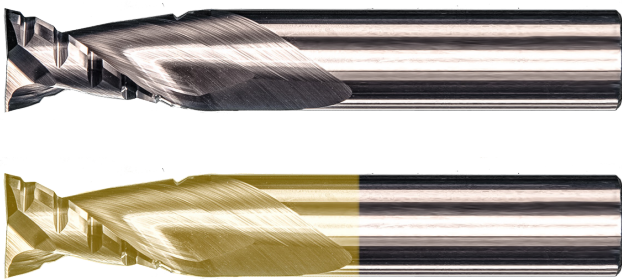

Uncoated
PowerZ



Length Key (K)

■ Stub
 ■ Standard
 ■ Long



	OD	LOC	SHK	OAL	Uncoated		PowerZ	
					2 Flute	3 Flute	2 Flute	3 Flute
	D1	L1	D2	L2	2 Flute	3 Flute	2 Flute	3 Flute
Standard	6	19	6	63	517-002	523-002	517-002-4	523-002-4
	8	20	8	63	517-004	523-004	517-004-4	523-004-4
	10	22	10	63	517-006	523-006	517-006-4	523-006-4
	12	25	12	75	517-008	523-008	517-008-4	523-008-4
	16	32	16	88	517-010	523-010	517-010-4	523-010-4
	20	36	20	100	517-012	523-012	517-012-4	523-012-4

CORNER RADIUS CHIPBREAKER AXMILLS



带碎屑刃Axmill倒R角铣刀

2 & 3 Flutes	coated and uncoated	Unique flute and relief angles for aluminum	Faster speeds and feeds
2 & 3刃	涂层 & 无涂层	独特的刀刃和后角设计适合铝材加工	更快的转速和进给

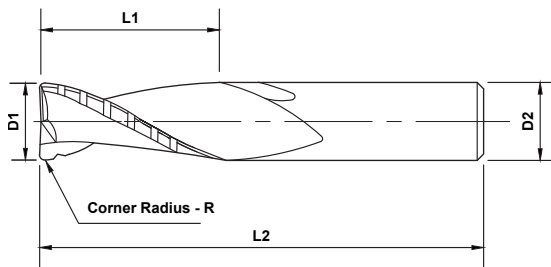

Non-Ferrous
N

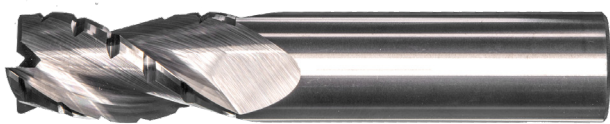

Uncoated



Length Key (K)

■ Stub
 ■ Standard
 ■ Long



	OD	LOC	SHK	OAL	Radius	Uncoated		PowerZ	
	D1	L1	D2	L2	R				
6		19	6	63	0.50	517-401	523-401	517-401-4	523-401-4
		19	6	63	1.00	517-403	523-403	517-403-4	523-403-4
8		20	8	63	0.50	517-411	523-411	517-411-4	523-411-4
		20	8	63	1.00	517-413	523-413	517-413-4	523-413-4
10		22	10	63	0.50	517-421	523-421	517-421-4	523-421-4
		22	10	63	1.00	517-423	523-423	517-423-4	523-423-4
12		25	12	75	0.50	517-431	523-431	517-431-4	523-431-4
		25	12	75	1.00	517-433	523-433	517-433-4	523-433-4
16		32	16	88	0.50	517-441	523-441	517-441-4	523-441-4
		32	16	88	1.00	517-443	523-443	517-443-4	523-443-4
20		36	20	100	0.50	517-451	523-451	517-451-4	523-451-4
		36	20	100	1.00	517-453	523-453	517-453-4	523-453-4

45° HELIX SQUARE HYPERMILLS

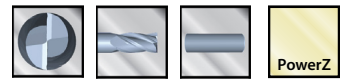

45°螺旋刃平底铝合金刀

HIGH PERFORMANCE ENDMILLS

2 Flutes	coated and uncoated
2刃	涂层 & 无涂层

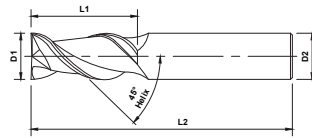

Non-Ferrous
N

	OD	LOC	SHK	OAL	Uncoated	PowerZ
	D1	L1	D2	L2		
	6	25	6	63	528-002	528-002-4
	8	25	8	63	528-004	528-004-4
	10	25	10	70	528-006	528-006-4
	12	32	12	75	528-008	528-008-4
	16	42	16	88	528-010	528-010-4
	20	48	20	100	528-012	528-012-4

55° HELIX SQUARE ALUMAZIPS

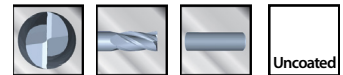

55°螺旋刃平底铝合金铣刀

2 Flutes	uncoated
2刃	无涂层



Uncoated

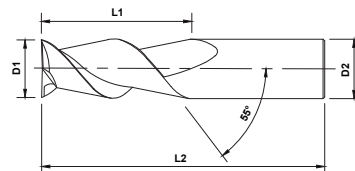

Non-Ferrous
N

	OD	LOC	SHK	OAL	Uncoated
	D1	L1	D2	L2	
	3	12	3	38	528-202
	4	14	4	50	528-204
	5	19	5	50	528-206
	6	19	6	63	528-208
	8	19	8	63	528-210
	10	22	10	70	528-212
	12	25	12	83	528-214
	14	30	14	83	528-216
	16	32	16	88	528-218
	20	38	20	100	528-220
	25	38	25	100	528-222

PRO+ PERFORMANCE ENDMILLS 超性能立铣刀

- **V4 Pro+**
- **V5 Pro+**
- **HY5 Pro+**
- **F45 Pro+**
- **V7 Pro+**

PRO+

Harness the power of our silicon based coatings; PowerN and PowerNR.

These coatings make our tools outstanding in high heat applications suited for hard material machining.

Our special honed flutes result in quieter running and an increase in overall tool precision.



































































利用我們的矽塗層的強大功能； PowerN和 PowerNR。

這些塗層使我們的工具在高溫應用中表現良好，並且適用於硬質材料加工。

我們的特殊珩磨槽可實現更安靜的操作並提高整體工具精度。

TABLE OF CONTENTS - 目录

	V4 Pro+ Square Endmills V4® V4 超 平底铣刀	84
	V4 Pro+ Ball Endmills V4® V4 超 球头铣刀	86
	V4 Pro+ Corner Radius Endmills V4® V4 超 倒R角刀铣刀	88
	V5 Pro+ Square Endmills V5® V5 超 平底铣刀	93
	V5 Pro+ Ball Endmills V5® V5 超 球头铣刀	94
	V5 Pro+ Corner Radius Endmills V5® V5 超 倒R角铣刀	95
	HY5 Pro+ Square Endmills HY5® HY5 超 平底铣刀	96
	HY5 Pro+ Corner Radius Endmills HY5® HY5 超 倒R角铣刀	97
	F45 Pro+ Square Endmills F45® F45, 超 6刃平底铣刀	102
	F45 Pro+ Corner Radius Endmills F45® F45, 超 6刃倒R角铣刀	103
	V7 Pro+ Endmills V7® V7, 超.	103











					
					
					
					
					
					
					
					
					
					
					

PRO+ PERFORMANCE ENDMILLS

LEGENDS



图示说明

Features - 产品特点

	4 Flutes 4刃		Square End 平底铣刀		Ball End 球头铣刀
	5 Flutes 5刃		Plain Shank 普通刀柄		Double End Sq. 双端平底方头铣刀
	6+ Flutes 6刃		Corner Radius 倒R角		Double End Ball 双端球头铣刀
	Weldon Flat 侧固刀柄				

Coatings

涂层

	Uncoated 无涂层		PowerN PowerN (nACo)		PowerNR PowerNR (nACro)
---	-----------------	---	-------------------------	---	----------------------------

V4 PRO+ SQUARE ENDMILLS

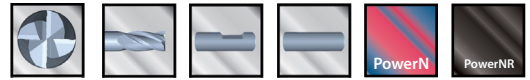

V4 超平底铣刀

4 Flutes 4刃	Coated with or without flat 涂层, 普通刀杆和侧固刀杆	Unique variable design, coating, and edge quality 独特的可变设计, 涂层和边缘质量
----------------	--	---

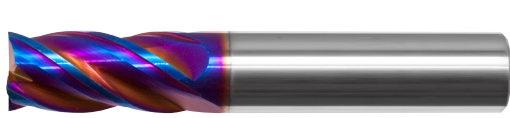
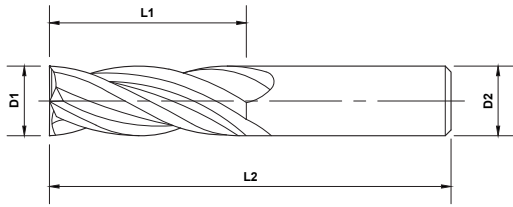

- Stub, Series 552, PowerN
- Standard, Series 550, PowerN
- Long, Series 551, PowerN

V4

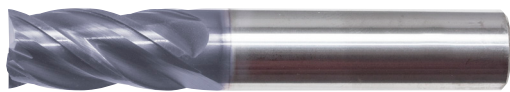

- Stub, Series 552, PowerNR
- Standard, Series 550, PowerNR
- Long, Series 551, PowerNR

PRO+

Length Key (K)

- Standard
- Stub
- Long

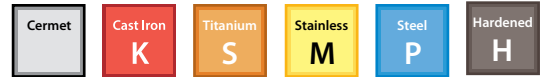

K	OD D1	LOC L1	SHK D2	OAL L2	PowerN		PowerNR	
					No Flat	With Flat	No Flat	With Flat
3		6	3	38	552-002-5	552-002W-5	552-002-8	552-002W-8
		12	3	38	550-002-5	550-002W-5	550-002-8	550-002W-8
		20	3	65	551-002-5	551-002W-5	551-002-8	551-002W-8
4		8	4	50	552-004-5	552-004W-5	552-004-8	552-004W-8
		20	4	65	551-004-5	551-004W-5	551-004-8	551-004W-8
5		10	5	50	552-006-5	552-006W-5	552-006-8	552-006W-8
		16	5	50	550-014-5	550-014W-5	550-014-8	550-014W-8
		20	5	75	551-006-5	551-006W-5	551-006-8	551-006W-8
6		12	6	50	552-008-5	552-008W-5	552-008-8	552-008W-8
		19	6	63	550-018-5	550-018W-5	550-018-8	550-018W-8
		25	6	75	551-008-5	551-008W-5	551-008-8	551-008W-8
8		12	8	50	552-012-5	552-012W-5	552-012-8	552-012W-8
		19	8	63	550-020-5	550-020W-5	550-020-8	550-020W-8
		25	8	75	551-010-5	551-010W-5	551-010-8	551-010W-8
10		14	10	50	552-014-5	552-014W-5	552-014-8	552-014W-8
		22	10	70	550-022-5	550-022W-5	550-022-8	550-022W-8
		38	10	100	551-012-5	551-012W-5	551-012-8	551-012W-8

We manufacture a full range of cutting diameters. Please call for availability.
我们生产全系列的切割直径。请致电查询空房情况。

V4 PRO+ SQUARE ENDMILLS

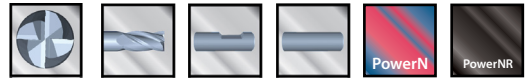

V4 超平底铣刀

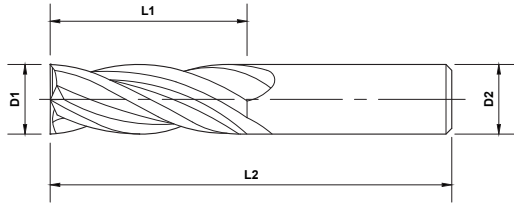

PRO+ PERFORMANCE ENDMILLS



Length Key (K)

Standard Stub Long



K	OD	LOC	SHK	OAL	PowerN		PowerNR	
	D1	L1	D2	L2	No Flat	With Flat	No Flat	With Flat
12	12	16	12	63	552-016-5	552-016W-5	552-016-8	552-016W-8
		25	12	75	550-024-5	550-024W-5	550-024-8	550-024W-8
		50	12	100	551-014-5	551-014W-5	551-014-8	551-014W-8
14	14	25	14	88	550-026-5	550-026W-5	550-026-8	550-026W-8
		56	14	125	551-016-5	551-016W-5	551-016-8	551-016W-8
16	16	32	16	88	550-028-5	550-028W-5	550-028-8	550-028W-8
		56	16	150	551-018-5	551-018W-5	551-018-8	551-018W-8
18	18	36	18	100	550-030-5	550-030W-5	550-030-8	550-030W-8
		56	18	150	551-020-5	551-020W-5	551-020-8	551-020W-8
20	20	38	20	100	550-032-5	550-032W-5	550-032-8	550-032W-8
		56	20	150	551-022-5	551-022W-5	551-022-8	551-022W-8
25	25	38	25	100	550-034-5	550-034W-5	550-034-8	550-034W-8
		70	25	150	551-024-5	551-024W-5	551-024-8	551-024W-8

We manufacture a full range of cutting diameters. Please call for availability.
我们生产全系列的切割直径。请致电查询空房情况。

V4 PRO+ BALL ENDMILLS

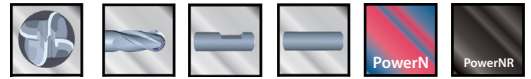

V4 超球头铣刀

4 Flutes 4刃	Coated with or without flat 涂层, 普通刀杆和侧固刀杆	Unique variable design, coating, and edge quality 独特的可变设计, 涂层和边缘质量
----------------	--	---

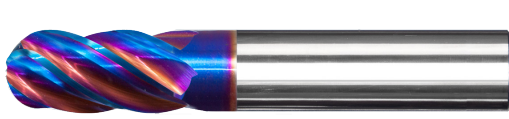
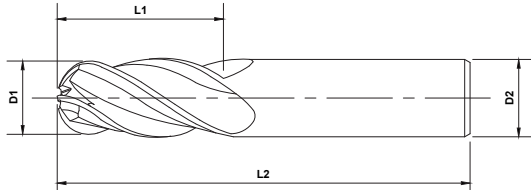

- Stub, Series 552, PowerN
- Standard, Series 550, PowerN
- Long, Series 551, PowerN



- Stub, Series 552, PowerNR
- Standard, Series 550, PowerNR
- Long, Series 551, PowerNR

Length Key (K)

■ Standard ■ Stub ■ Long



K	OD	LOC	SHK	OAL	PowerN		PowerNR	
					No Flat	With Flat	No Flat	With Flat
3	D1	L1	D2	L2	552-202-5	552-202W-5	552-202-8	552-202W-8
		6	3	38	550-202-5	550-202W-5	550-202-8	550-202W-8
		12	3	38	551-202-5	551-202W-5	551-202-8	551-202W-8
4	D1	L1	D2	L2	552-204-5	552-204W-5	552-204-8	552-204W-8
		8	4	50	550-208-5	550-208W-5	550-208-8	550-208W-8
		14	4	50	551-204-5	551-204W-5	551-204-8	551-204W-8
5	D1	L1	D2	L2	552-206-5	552-206W-5	552-206-8	552-206W-8
		10	5	50	550-214-5	550-214W-5	550-214-8	550-214W-8
		16	5	50	551-206-5	551-206W-5	551-206-8	551-206W-8
6	D1	L1	D2	L2	552-208-5	552-208W-5	552-208-8	552-208W-8
		12	6	50	550-218-5	550-218W-5	550-218-8	550-218W-8
		19	6	63	551-208-5	551-208W-5	551-208-8	551-208W-8
8	D1	L1	D2	L2	552-212-5	552-212W-5	552-212-8	552-212W-8
		12	8	50	550-220-5	550-220W-5	550-220-8	550-220W-8
		19	8	63	551-210-5	551-210W-5	551-210-8	551-210W-8
10	D1	L1	D2	L2	552-214-5	552-214W-5	552-214-8	552-214W-8
		14	10	50	550-222-5	550-222W-5	550-222-8	550-222W-8
		22	10	70	551-212-5	551-212W-5	551-212-8	551-212W-8
					552-214-5	552-214W-5	552-214-8	552-214W-8
					550-222-5	550-222W-5	550-222-8	550-222W-8
					551-212-5	551-212W-5	551-212-8	551-212W-8

We manufacture a full range of cutting diameters. Please call for availability.
我们生产全系列的切割直径。请致电查询空房情况。

V4 PRO+ BALL ENDMILLS

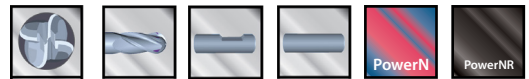

V4 超球头铣刀

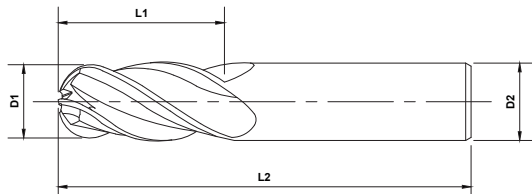

PRO+ PERFORMANCE ENDMILLS

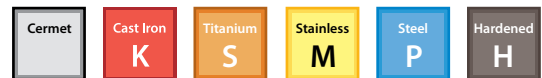

Length Key (K)

Standard Stub Long



K	OD	LOC	SHK	OAL	PowerN		PowerNR	
	D1	L1	D2	L2	No Flat	With Flat	No Flat	With Flat
12	12	16	12	63	552-216-5	552-216W-5	552-216-8	552-216W-8
		25	12	75	550-224-5	550-224W-5	550-224-8	550-224W-8
		50	12	100	551-214-5	551-214W-5	551-214-8	551-214W-8
14	14	25	14	88	550-226-5	550-226W-5	550-226-8	550-226W-8
		56	14	125	551-216-5	551-216W-5	551-216-8	551-216W-8
16	16	32	16	88	550-228-5	550-228W-5	550-228-8	550-228W-8
		56	16	150	551-218-5	551-218W-5	551-218-8	551-218W-8
18	18	36	18	100	550-230-5	550-230W-5	550-230-8	550-230W-8
		56	18	150	551-220-5	551-220W-5	551-220-8	551-220W-8
20	20	38	20	100	550-232-5	550-232W-5	550-232-8	550-232W-8
		56	20	150	551-222-5	551-222W-5	551-222-8	551-222W-8
25	25	38	25	100	550-234-5	550-234W-5	550-234-8	550-234W-8
		70	25	150	551-224-5	551-224W-5	551-224-8	551-224W-8

We manufacture a full range of cutting diameters. Please call for availability.
我们生产全系列的切割直径。请致电查询空房情况。

V4 PRO+ CORNER RADIUS

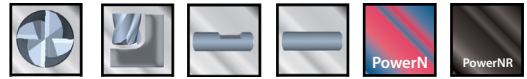

V4 超 倒R角刀铣刀

4 Flutes	Coated with or without flat
4刃	涂层, 普通刀杆和侧固刀杆
Unique variable design, coating, and edge quality	Quiet operation and better finish
独特的可变设计, 涂层和边缘质量	运行安静和更好的表面光洁度

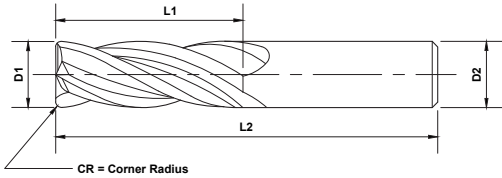

- Stub, Series 552, PowerN
- Standard, Series 550, PowerN
- Long, Series 551, PowerN

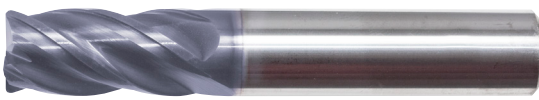

- Stub, Series 552, PowerNR
- Standard, Series 550, PowerNR
- Long, Series 551, PowerNR



Length Key (K)



K	OD	LOC	SHK	OAL	Radius	PowerN		PowerNR			
						No Flat	With Flat	No Flat	With Flat		
3	D1	L1	D2	L2	R	552-401-5	552-401W-5	552-401-8	552-401W-8		
						552-402-5	552-402W-5	552-402-8	552-402W-8		
						552-403-5	552-403W-5	552-403-8	552-403W-8		
						552-404-5	552-404W-5	552-404-8	552-404W-8		
		3	3	38	38	0.25	550-400-5	550-400W-5	550-400-8	550-400W-8	
							550-401-5	550-401W-5	550-401-8	550-401W-8	
							550-402-5	550-402W-5	550-402-8	550-402W-8	
							551-400-5	551-400W-5	551-400-8	551-400W-8	
				20	3	65	0.25	551-401-5	551-401W-5	551-401-8	551-401W-8
								551-402-5	551-402W-5	551-402-8	551-402W-8
								551-403-5	551-403W-5	551-403-8	551-403W-8
								551-404-5	551-404W-5	551-404-8	551-404W-8
4	D1	L1	D2	L2	R	552-410-5	552-410W-5	552-410-8	552-410W-8		
						552-411-5	552-411W-5	552-411-8	552-411W-8		
						552-412-5	552-412W-5	552-412-8	552-412W-8		
						552-413-5	552-413W-5	552-413-8	552-413W-8		
		4	4	50	50	0.25	550-420-5	550-420W-5	550-420-8	550-420W-8	
							550-421-5	550-421W-5	550-421-8	550-421W-8	
							550-422-5	550-422W-5	550-422-8	550-422W-8	
							550-423-5	550-423W-5	550-423-8	550-423W-8	
				20	4	65	0.25	551-410-5	551-410W-5	551-410-8	551-410W-8
								551-411-5	551-411W-5	551-411-8	551-411W-8
								551-412-5	551-412W-5	551-412-8	551-412W-8
								551-413-5	551-413W-5	551-413-8	551-413W-8
5	D1	L1	D2	L2	R	552-420-5	552-420W-5	552-420-8	552-420W-8		
						552-421-5	552-421W-5	552-421-8	552-421W-8		
						552-422-5	552-422W-5	552-422-8	552-422W-8		
		16	5	50	0.25	550-440-5	550-440W-5	550-440-8	550-440W-8		
						550-441-5	550-441W-5	550-441-8	550-441W-8		
						550-442-5	550-442W-5	550-442-8	550-442W-8		

We manufacture a full range of cutting diameters and endcut radii. Please call for availability.
我们生产全系列的切割直径。请致电查询空房情况。

V4 PRO+ CORNER RADIUS

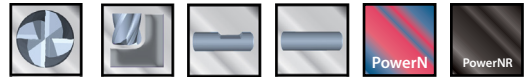

V4 超 倒R角刀铣刀

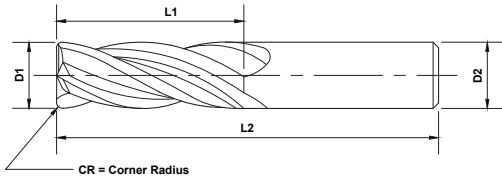

Length Key (K)



K	OD	LOC	SHK	OAL	Radius	PowerN		PowerNR	
	D1	L1	D2	L2	R	No Flat	With Flat	No Flat	With Flat
5	16	16	5	50	0.75	550-442-5	550-442W-5	550-442-8	550-442W-8
		16	5	50	1.00	550-443-5	550-443W-5	550-443-8	550-443W-8
		20	5	75	0.25	551-420-5	551-420W-5	551-420-8	551-420W-8
		20	5	75	0.50	551-422-5	551-422W-5	551-422-8	551-422W-8
		20	5	75	0.75	551-423-5	551-423W-5	551-423-8	551-423W-8
		20	5	75	1.00	551-424-5	551-424W-5	551-424-8	551-424W-8
6	12	12	6	50	0.25	552-430-5	552-430W-5	552-430-8	552-430W-8
		12	6	50	0.50	552-431-5	552-431W-5	552-431-8	552-431W-8
		12	6	50	0.75	552-432-5	552-432W-5	552-432-8	552-432W-8
		12	6	50	1.00	552-433-5	552-433W-5	552-433-8	552-433W-8
		12	6	50	1.25	552-434-5	552-434W-5	552-434-8	552-434W-8
		12	6	50	1.50	552-435-5	552-435W-5	552-435-8	552-435W-8
	19	19	6	63	0.25	550-460-5	550-460W-5	550-460-8	550-460W-8
		19	6	63	0.50	550-461-5	550-461W-5	550-461-8	550-461W-8
		19	6	63	0.75	550-462-5	550-462W-5	550-462-8	550-462W-8
		19	6	63	1.00	550-463-5	550-463W-5	550-463-8	550-463W-8
		19	6	63	1.25	550-464-5	550-464W-5	550-464-8	550-464W-8
		19	6	63	1.50	550-465-5	550-465W-5	550-465-8	550-465W-8
	25	25	6	75	0.25	551-430-5	551-430W-5	551-430-8	551-430W-8
		25	6	75	0.50	551-431-5	551-431W-5	551-431-8	551-431W-8
		25	6	75	0.75	551-432-5	551-432W-5	551-432-8	551-432W-8
		25	6	75	1.00	551-433-5	551-433W-5	551-433-8	551-433W-8
		25	6	75	1.25	551-434-5	551-434W-5	551-434-8	551-434W-8
		25	6	75	1.50	551-435-5	551-435W-5	551-435-8	551-435W-8
8	12	12	8	50	0.50	552-451-5	552-451W-5	552-451-8	552-451W-8
		12	8	50	0.75	552-452-5	552-452W-5	552-452-8	552-452W-8
		12	8	50	1.00	552-453-5	552-453W-5	552-453-8	552-453W-8
		12	8	50	1.25	552-454-5	552-454W-5	552-454-8	552-454W-8
		12	8	50	1.50	552-455-5	552-455W-5	552-455-8	552-455W-8
		12	8	50	2.00	552-456-5	552-456W-5	552-456-8	552-456W-8
	19	19	8	63	0.50	550-471-5	550-471W-5	550-471-8	550-471W-8
		19	8	63	0.75	550-472-5	550-472W-5	550-472-8	550-472W-8
		19	8	63	1.00	550-473-5	550-473W-5	550-473-8	550-473W-8
		19	8	63	1.25	550-474-5	550-474W-5	550-474-8	550-474W-8
		19	8	63	1.50	550-475-5	550-475W-5	550-475-8	550-475W-8
		19	8	63	2.00	550-476-5	550-476W-5	550-476-8	550-476W-8
		19	8	63	3.00	550-477-5	550-477W-5	550-477-8	550-477W-8

We manufacture a full range of cutting diameters and endcut radii. Please call for availability. 我们生产全系列的切割直径。请致电查询空房情况。



V4 PRO+ CORNER RADIUS

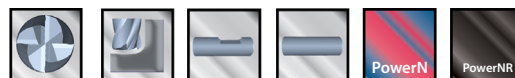

V4 超 倒R角刀铣刀

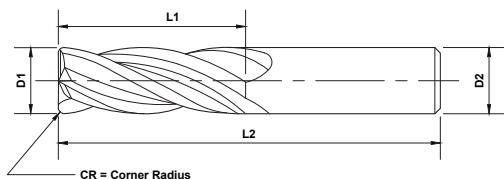

Length Key (K)



K	OD	LOC	SHK	OAL	Radius	PowerN		PowerNR						
	D1	L1	D2	L2	R	No Flat	With Flat	No Flat	With Flat					
8	25	8	8	75	0.50	551-441-5	551-441W-5	551-441-8	551-441W-8					
					0.75	551-442-5	551-442W-5	551-442-8	551-442W-8					
					1.00	551-443-5	551-443W-5	551-443-8	551-443W-8					
					1.25	551-444-5	551-444W-5	551-444-8	551-444W-8					
					1.50	551-445-5	551-445W-5	551-445-8	551-445W-8					
					2.00	551-446-5	551-446W-5	551-446-8	551-446W-8					
					3.00	551-447-5	551-447W-5	551-447-8	551-447W-8					
10	14	10	50	50	0.50	552-461-5	552-461W-5	552-461-8	552-461W-8					
					0.75	552-462-5	552-462W-5	552-462-8	552-462W-8					
					1.00	552-463-5	552-463W-5	552-463-8	552-463W-8					
					1.25	552-464-5	552-464W-5	552-464-8	552-464W-8					
					1.50	552-465-5	552-465W-5	552-465-8	552-465W-8					
					2.00	552-466-5	552-466W-5	552-466-8	552-466W-8					
					3.00	552-467-5	552-467W-5	552-467-8	552-467W-8					
					22	10	70	70	70	0.50	550-481-5	550-481W-5	550-481-8	550-481W-8
										0.75	550-482-5	550-482W-5	550-482-8	550-482W-8
										1.00	550-483-5	550-483W-5	550-483-8	550-483W-8
										1.25	550-484-5	550-484W-5	550-484-8	550-484W-8
										1.50	550-485-5	550-485W-5	550-485-8	550-485W-8
										2.00	550-486-5	550-486W-5	550-486-8	550-486W-8
					38	10	100	100	100	0.50	551-451-5	551-451W-5	551-451-8	551-451W-8
0.75	551-452-5	551-452W-5	551-452-8	551-452W-8										
1.00	551-453-5	551-453W-5	551-453-8	551-453W-8										
1.25	551-454-5	551-454W-5	551-454-8	551-454W-8										
1.50	551-455-5	551-455W-5	551-455-8	551-455W-8										
2.00	551-456-5	551-456W-5	551-456-8	551-456W-8										
3.00	551-457-5	551-457W-5	551-457-8	551-457W-8										
12	16	12	63	63						0.50	552-471-5	552-471W-5	552-471-8	552-471W-8
					0.75	552-472-5	552-472W-5	552-472-8	552-472W-8					
					1.00	552-473-5	552-473W-5	552-473-8	552-473W-8					
					1.25	552-474-5	552-474W-5	552-474-8	552-474W-8					
					1.50	552-475-5	552-475W-5	552-475-8	552-475W-8					
					2.00	552-476-5	552-476W-5	552-476-8	552-476W-8					
					3.00	552-477-5	552-477W-5	552-477-8	552-477W-8					
					4.00	552-478-5	552-478W-5	552-478-8	552-478W-8					
					25	12	75	75	75	0.50	550-491-5	550-491W-5	550-491-8	550-491W-8
										0.75	550-492-5	550-492W-5	550-492-8	550-492W-8
										1.00	550-493-5	550-493W-5	550-493-8	550-493W-8
										1.25	550-494-5	550-494W-5	550-494-8	550-494W-8
										1.50	550-495-5	550-495W-5	550-495-8	550-495W-8
										2.00	550-496-5	550-496W-5	550-496-8	550-496W-8
										3.00	550-497-5	550-497W-5	550-497-8	550-497W-8
										4.00	550-498-5	550-498W-5	550-498-8	550-498W-8

We manufacture a full range of cutting diameters and endcut radii. Please call for availability.
我们生产全系列的切割直径。请致电查询空房情况。

V4 PRO+ CORNER RADIUS

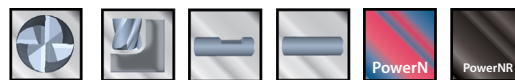

V4 超 倒R角刀铣刀

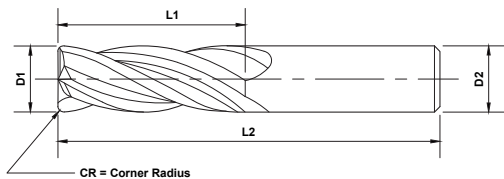

Length Key (K)



PRO+ PERFORMANCE ENDMILLS

K	OD	LOC	SHK	OAL	Radius	PowerN		PowerNR	
	D1	L1	D2	L2	R	No Flat	With Flat	No Flat	With Flat
12	50	50	12	100	0.50	551-461-5	551-461W-5	551-461-8	551-461W-8
		50	12	100	0.75	551-462-5	551-462W-5	551-462-8	551-462W-8
		50	12	100	1.00	551-463-5	551-463W-5	551-463-8	551-463W-8
		50	12	100	1.25	551-464-5	551-464W-5	551-464-8	551-464W-8
		50	12	100	1.50	551-465-5	551-465W-5	551-465-8	551-465W-8
		50	12	100	2.00	551-466-5	551-466W-5	551-466-8	551-466W-8
		50	12	100	3.00	551-467-5	551-467W-5	551-467-8	551-467W-8
14	25	25	14	88	0.50	550-501-5	550-501W-5	550-501-8	550-501W-8
		25	14	88	0.75	550-502-5	550-502W-5	550-502-8	550-502W-8
		25	14	88	1.00	550-503-5	550-503W-5	550-503-8	550-503W-8
		25	14	88	1.50	550-505-5	550-505W-5	550-505-8	550-505W-8
		25	14	88	2.00	550-506-5	550-506W-5	550-506-8	550-506W-8
		25	14	88	3.00	550-507-5	550-507W-5	550-507-8	550-507W-8
		25	14	88	4.00	550-508-5	550-508W-5	550-508-8	550-508W-8
	56	56	14	125	0.50	551-471-5	551-471W-5	551-471-8	551-471W-8
		56	14	125	0.75	551-472-5	551-472W-5	551-472-8	551-472W-8
		56	14	125	1.00	551-473-5	551-473W-5	551-473-8	551-473W-8
		56	14	125	1.50	551-475-5	551-475W-5	551-475-8	551-475W-8
		56	14	125	2.00	551-476-5	551-476W-5	551-476-8	551-476W-8
		56	14	125	3.00	551-477-5	551-477W-5	551-477-8	551-477W-8
16	32	32	16	88	0.50	550-511-5	550-511W-5	550-511-8	550-511W-8
		32	16	88	0.75	550-512-5	550-512W-5	550-512-8	550-512W-8
		32	16	88	1.00	550-513-5	550-513W-5	550-513-8	550-513W-8
		32	16	88	1.50	550-515-5	550-515W-5	550-515-8	550-515W-8
		32	16	88	2.00	550-516-5	550-516W-5	550-516-8	550-516W-8
		32	16	88	3.00	550-517-5	550-517W-5	550-517-8	550-517W-8
		32	16	88	4.00	550-518-5	550-518W-5	550-518-8	550-518W-8
	56	56	16	150	0.50	551-481-5	551-481W-5	551-481-8	551-481W-8
		56	16	150	0.75	551-482-5	551-482W-5	551-482-8	551-482W-8
		56	16	150	1.00	551-483-5	551-483W-5	551-483-8	551-483W-8
		56	16	150	1.50	551-485-5	551-485W-5	551-485-8	551-485W-8
		56	16	150	2.00	551-486-5	551-486W-5	551-486-8	551-486W-8
		56	16	150	3.00	551-487-5	551-487W-5	551-487-8	551-487W-8
18	36	36	18	100	0.50	550-521-5	550-521W-5	550-521-8	550-521W-8
		36	18	100	0.75	550-522-5	550-522W-5	550-522-8	550-522W-8
		36	18	100	1.00	550-523-5	550-523W-5	550-523-8	550-523W-8
		36	18	100	1.50	550-525-5	550-525W-5	550-525-8	550-525W-8
		36	18	100	2.00	550-526-5	550-526W-5	550-526-8	550-526W-8
		36	18	100	3.00	550-527-5	550-527W-5	550-527-8	550-527W-8
		36	18	100	4.00	550-528-5	550-528W-5	550-528-8	550-528W-8

We manufacture a full range of cutting diameters and endcut radii. Please call for availability. 我们生产全系列的切割直径。请致电查询空房情况。

V4 PRO+ CORNER RADIUS

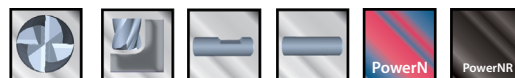

V4 超 倒R角刀铣刀

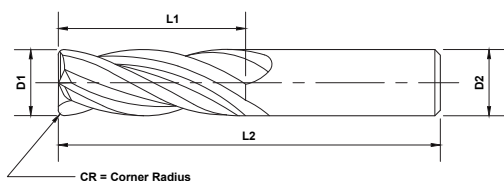

Length Key (K)

Standard Stub Long



K	OD	LOC	SHK	OAL	Radius	PowerN		PowerNR		
	D1	L1	D2	L2	R	No Flat	With Flat	No Flat	With Flat	
18	56	18	18	150	0.50	551-491-5	551-491W-5	551-491-8	551-491W-8	
					0.75	551-492-5	551-492W-5	551-492-8	551-492W-8	
					1.00	551-493-5	551-493W-5	551-493-8	551-493W-8	
					1.50	551-495-5	551-495W-5	551-495-8	551-495W-8	
					2.00	551-496-5	551-496W-5	551-496-8	551-496W-8	
					3.00	551-497-5	551-497W-5	551-497-8	551-497W-8	
					4.00	551-498-5	551-498W-5	551-498-8	551-498W-8	
20	38	20	100	100	0.50	550-531-5	550-531W-5	550-531-8	550-531W-8	
					0.75	550-532-5	550-532W-5	550-532-8	550-532W-8	
					1.00	550-533-5	550-533W-5	550-533-8	550-533W-8	
					1.50	550-535-5	550-535W-5	550-535-8	550-535W-8	
					2.00	550-536-5	550-536W-5	550-536-8	550-536W-8	
					3.00	550-537-5	550-537W-5	550-537-8	550-537W-8	
					4.00	550-538-5	550-538W-5	550-538-8	550-538W-8	
	56	20	150	150	150	0.50	551-501-5	551-501W-5	551-501-8	551-501W-8
						0.75	551-502-5	551-502W-5	551-502-8	551-502W-8
						1.00	551-503-5	551-503W-5	551-503-8	551-503W-8
						1.50	551-505-5	551-505W-5	551-505-8	551-505W-8
						2.00	551-506-5	551-506W-5	551-506-8	551-506W-8
						3.00	551-507-5	551-507W-5	551-507-8	551-507W-8
						4.00	551-508-5	551-508W-5	551-508-8	551-508W-8
5.00	551-509-5	551-509W-5	551-509-8	551-509W-8						
25	38	25	100	100	0.50	550-541-5	550-541W-5	550-541-8	550-541W-8	
					0.75	550-542-5	550-542W-5	550-542-8	550-542W-8	
					1.00	550-543-5	550-543W-5	550-543-8	550-543W-8	
					1.50	550-545-5	550-545W-5	550-545-8	550-545W-8	
					2.00	550-546-5	550-546W-5	550-546-8	550-546W-8	
					3.00	550-547-5	550-547W-5	550-547-8	550-547W-8	
					4.00	550-548-5	550-548W-5	550-548-8	550-548W-8	
	70	25	150	150	150	0.50	551-511-5	551-511W-5	551-511-8	551-511W-8
						0.75	551-512-5	551-512W-5	551-512-8	551-512W-8
						1.00	551-513-5	551-513W-5	551-513-8	551-513W-8
						1.50	551-515-5	551-515W-5	551-515-8	551-515W-8
						2.00	551-516-5	551-516W-5	551-516-8	551-516W-8
						3.00	551-517-5	551-517W-5	551-517-8	551-517W-8
						4.00	551-518-5	551-518W-5	551-518-8	551-518W-8
5.00	551-519-5	551-519W-5	551-519-8	551-519W-8						

We manufacture a full range of cutting diameters and endcut radii. Please call for availability. 我们生产全系列的切割直径。请致电查询空房情况。

V5 PRO+ SQUARE ENDMILLS

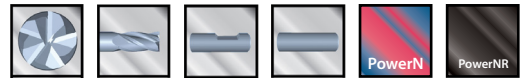

V5 超平底铣刀

5 Flutes 5刃	Coated with or without flat 涂层, 普通刀杆和侧固刀杆	Quiet operation and better finish 运行安静和更好的表面光洁度
----------------	--	--

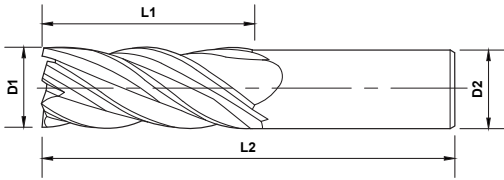

PRO+ PERFORMANCE ENDMILLS

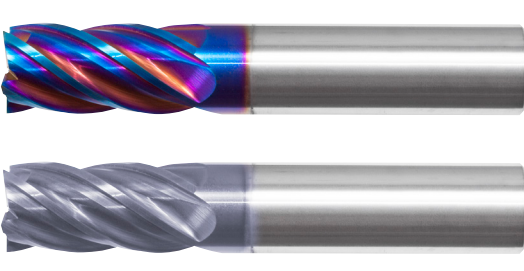

- Stub, Series 555, PowerN
 - Standard, Series 553, PowerN
 - Long, Series 554, PowerN
-
- Stub, Series 555, PowerNR
 - Standard, Series 553, PowerNR
 - Long, Series 554, PowerNR



Length Key (K)

Standard
 Stub
 Long



K	OD	LOC	SHK	OAL	PowerN		PowerNR	
	D1	L1	D2	L2	No Flat	With Flat	No Flat	With Flat
8	8	12	8	50	555-010-5	555-010W-5	555-010-8	555-010W-8
		19	8	63	553-010-5	553-010W-5	553-010-8	553-010W-8
		25	8	75	554-010-5	554-010W-5	554-010-8	554-010W-8
10	10	14	10	50	555-012-5	555-012W-5	555-012-8	555-012W-8
		22	10	70	553-012-5	553-012W-5	553-012-8	553-012W-8
		38	10	100	554-012-5	554-012W-5	554-012-8	554-012W-8
12	12	16	12	63	555-014-5	555-014W-5	555-014-8	555-014W-8
		25	12	75	553-014-5	553-014W-5	553-014-8	553-014W-8
		50	12	100	554-014-5	554-014W-5	554-014-8	554-014W-8
14	14	25	14	88	553-016-5	553-016W-5	553-016-8	553-016W-8
		56	14	125	554-016-5	554-016W-5	554-016-8	554-016W-8
16	16	32	16	88	553-018-5	553-018W-5	553-018-8	553-018W-8
		56	16	150	554-018-5	554-018W-5	554-018-8	554-018W-8
18	18	36	18	100	553-020-5	553-020W-5	553-020-8	553-020W-8
		56	18	150	554-020-5	554-020W-5	554-020-8	554-020W-8
20	20	38	20	100	553-022-5	553-022W-5	553-022-8	553-022W-8
		56	20	150	554-022-5	554-022W-5	554-022-8	554-022W-8
25	25	38	25	100	553-024-5	553-024W-5	553-024-8	553-024W-8
		70	25	150	554-024-5	554-024W-5	554-024-8	554-024W-8

We manufacture a full range of cutting diameters. Please call for availability.
我们生产全系列的切割直径。请致电查询空房情况。

V5 PRO+ BALL ENDMILLS

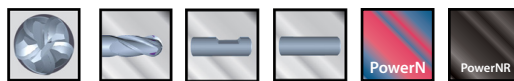

V5 超球头铣刀

5 Flutes 5刃	Coated with or without flat 涂层, 普通刀杆和侧固刀杆	Quiet operation and better finish 运行安静和更好的表面光洁度
----------------	--	--

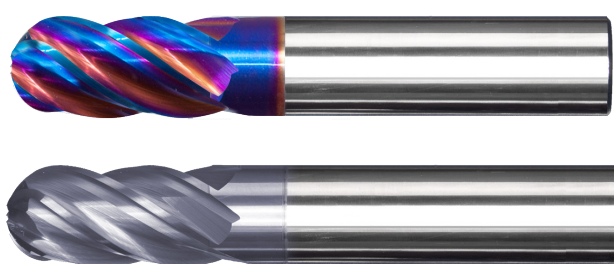
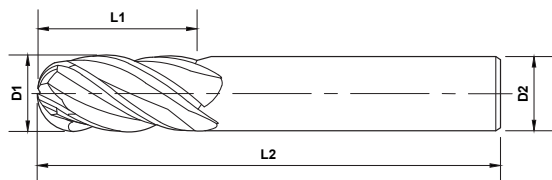

- Stub, Series 555, PowerN
 - Standard, Series 553, PowerN
 - Long, Series 554, PowerN
-
- Stub, Series 555, PowerNR
 - Standard, Series 553, PowerNR
 - Long, Series 554, PowerNR



Length Key (K)

Standard
 Stub
 Long



K	OD	LOC	SHK	OAL	PowerN		PowerNR	
	D1	L1	D2	L2	No Flat	With Flat	No Flat	With Flat
8	8	12	8	50	555-210-5	555-210W-5	555-210-8	555-210W-8
		19	8	63	553-210-5	553-210W-5	553-210-8	553-210W-8
		25	8	75	554-210-5	554-210W-5	554-210-8	554-210W-8
10	10	14	10	50	555-212-5	555-212W-5	555-212-8	555-212W-8
		22	10	70	553-212-5	553-212W-5	553-212-8	553-212W-8
		38	10	100	554-212-5	554-212W-5	554-212-8	554-212W-8
12	12	16	12	63	555-214-5	555-214W-5	555-214-8	555-214W-8
		25	12	75	553-214-5	553-214W-5	553-214-8	553-214W-8
		50	12	100	554-214-5	554-214W-5	554-214-8	554-214W-8
14	14	25	14	88	553-216-5	553-216W-5	553-216-8	553-216W-8
		56	14	125	554-216-5	554-216W-5	554-216-8	554-216W-8
16	16	32	16	88	553-218-5	553-218W-5	553-218-8	553-218W-8
		56	16	150	554-218-5	554-218W-5	554-218-8	554-218W-8
18	18	36	18	100	553-220-5	553-220W-5	553-220-8	553-220W-8
		56	18	150	554-220-5	554-220W-5	554-220-8	554-220W-8
20	20	38	20	100	553-222-5	553-222W-5	553-222-8	553-222W-8
		56	20	150	554-222-5	554-222W-5	554-222-8	554-222W-8
25	25	38	25	100	553-224-5	553-224W-5	553-224-8	553-224W-8
		70	25	150	554-224-5	554-224W-5	554-224-8	554-224W-8

We manufacture a full range of cutting diameters. Please call for availability.
我们生产全系列的切割直径。请致电查询空房情况。

V5 PRO+ CORNER RADIUS

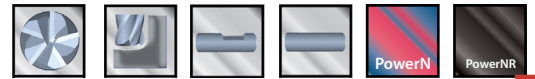

V5 超 倒R角铣刀

5 Flutes 5刃	Coated with or without flat 涂层, 普通刀杆和侧固刀杆	Quiet operation and better finish 运行安静和更好的表面光洁度
----------------	--	--

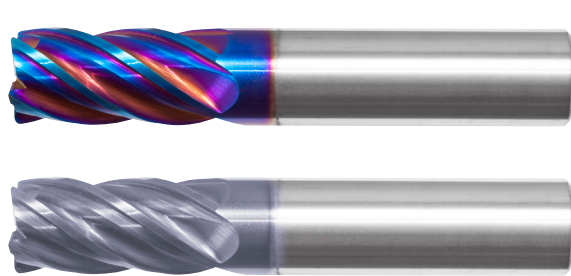
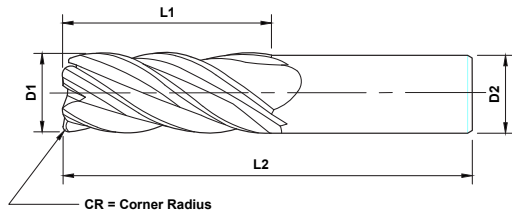

- Stub, Series 555, PowerN
 - Standard, Series 553, PowerN
 - Long, Series 554, PowerN
-
- Stub, Series 555, PowerNR
 - Standard, Series 553, PowerNR
 - Long, Series 554, PowerNR



Length Key (K)

- Standard
- Stub
- Long



K	OD D1	LOC L1	SHK D2	OAL L2	Radius R	PowerN		PowerNR	
						No Flat	With Flat	No Flat	With Flat
8	8	12	8	50	0.50	555-441-5	555-441W-5	555-441-8	555-441W-8
		19	8	63	0.50	553-441-5	553-441W-5	553-441-8	553-441W-8
		25	8	75	0.50	554-441-5	554-441W-5	554-441-8	554-441W-8
10	10	14	10	50	0.50	555-451-5	555-451W-5	555-451-8	555-451W-8
		22	10	70	0.50	553-451-5	553-451W-5	553-451-8	553-451W-8
		38	10	100	0.50	554-451-5	554-451W-5	554-451-8	554-451W-8
12	12	16	12	63	0.75	555-462-5	555-462W-5	555-462-8	555-462W-8
		25	12	75	0.75	553-462-5	553-462W-5	553-462-8	553-462W-8
		50	12	100	0.75	554-462-5	554-462W-5	554-462-8	554-462W-8
14	14	25	14	88	0.75	553-472-5	553-472W-5	553-472-8	553-472W-8
		56	14	125	0.75	554-472-5	554-472W-5	554-472-8	554-472W-8
16	16	32	16	88	0.75	553-482-5	553-482W-5	553-482-8	553-482W-8
		56	16	150	0.75	554-482-5	554-482W-5	554-482-8	554-482W-8
18	18	36	18	100	0.75	553-492-5	553-492W-5	553-492-8	553-492W-8
		56	18	150	0.75	554-492-5	554-492W-5	554-492-8	554-492W-8
20	20	38	20	100	0.75	553-502-5	553-502W-5	553-502-8	553-502W-8
		56	20	150	0.75	554-502-5	554-502W-5	554-502-8	554-502W-8
25	25	38	25	100	0.75	553-512-5	553-512W-5	553-512-8	553-512W-8
		70	25	150	0.75	554-512-5	554-512W-5	554-512-8	554-512W-8

We manufacture a full range of cutting diameters and endcut radii. Please call for availability.
我们生产全系列的切割直径。请致电查询空房情况。

HY5 PRO+ SQUARE ENDMILLS

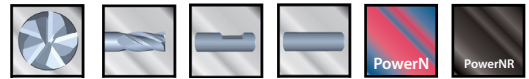

HY5 超平底铣刀

5 Flutes 5刃	Coated with or without flat 涂层, 普通刀杆和侧固刀杆	Unique 45° 5 flute design, superior coating and edge quality 独特的45°5长笛设计, 卓越的涂层和边缘质量
----------------	--	---

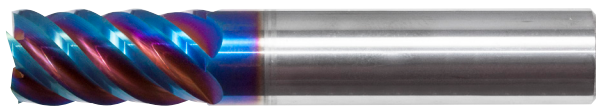
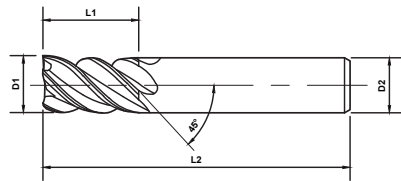

- Stub, Series 558, PowerN
- Standard, Series 556, PowerN
- Long, Series 557, PowerN

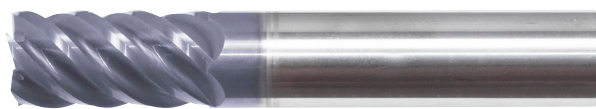

- Stub, Series 558, PowerNR
- Standard, Series 556, PowerNR
- Long, Series 557, PowerNR



Length Key (K)



K	OD	LOC	SHK	OAL	PowerN		PowerNR	
	D1	L1	D2	L2	No Flat	With Flat	No Flat	With Flat
3		6	3	38	558-002-5	558-002W-5	558-002-8	558-002W-8
		12	3	38	556-002-5	556-002W-5	556-002-8	556-002W-8
		20	3	65	557-002-5	557-002W-5	557-002-8	557-002W-8
4		8	4	50	558-004-5	558-004W-5	558-004-8	558-004W-8
		14	4	50	556-008-5	556-008W-5	556-008-8	556-008W-8
		20	4	65	557-004-5	557-004W-5	557-004-8	557-004W-8
5		10	5	50	558-006-5	558-006W-5	558-006-8	558-006W-8
		16	5	50	556-014-5	556-014W-5	556-014-8	556-014W-8
		20	5	75	557-006-5	557-006W-5	557-006-8	557-006W-8
6		12	6	50	558-008-5	558-008W-5	558-008-8	558-008W-8
		19	6	63	556-018-5	556-018W-5	556-018-8	556-018W-8
		25	6	75	557-008-5	557-008W-5	557-008-8	557-008W-8
8		12	8	50	558-012-5	558-012W-5	558-012-8	558-012W-8
		19	8	63	556-020-5	556-020W-5	556-020-8	556-020W-8
		25	8	75	557-010-5	557-010W-5	557-010-8	557-010W-8
10		14	10	50	558-014-5	558-014W-5	558-014-8	558-014W-8
		22	10	70	556-022-5	556-022W-5	556-022-8	556-022W-8
		38	10	100	557-012-5	557-012W-5	557-012-8	557-012W-8
12		16	12	63	558-016-5	558-016W-5	558-016-8	558-016W-8
		25	12	75	556-024-5	556-024W-5	556-024-8	556-024W-8
		50	12	100	557-014-5	557-014W-5	557-014-8	557-014W-8
14		25	14	88	556-026-5	556-026W-5	556-026-8	556-026W-8
		56	14	125	557-016-5	557-016W-5	557-016-8	557-016W-8
16		32	16	88	556-028-5	556-028W-5	556-028-8	556-028W-8
		56	16	150	557-018-5	557-018W-5	557-018-8	557-018W-8
18		36	18	100	556-030-5	556-030W-5	556-030-8	556-030W-8
		56	18	150	557-020-5	557-020W-5	557-020-8	557-020W-8
20		38	20	100	556-032-5	556-032W-5	556-032-8	556-032W-8
		56	20	150	557-022-5	557-022W-5	557-022-8	557-022W-8
25		38	25	100	556-034-5	556-034W-5	556-034-8	556-034W-8
		70	25	150	557-024-5	557-024W-5	557-024-8	557-024W-8

We manufacture a full range of cutting diameters. Please call for availability.
我们生产全系列的切割直径。请致电查询空房情况。

HY5 PRO+ CORNER RADIUS

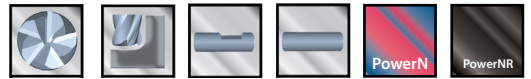

HY5 超 倒R角铣刀

5 Flutes 5刃	Coated with or without flat 涂层, 普通刀杆和侧固刀杆	Unique 45° 5 flute design, superior coating and edge quality 独特的45°5长笛设计, 卓越的涂层和边缘质量
----------------	--	---

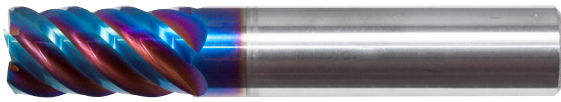
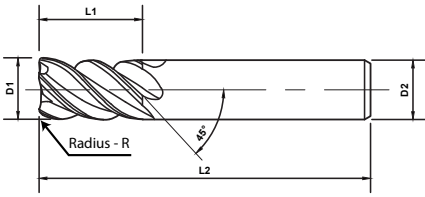

- Stub, Series 558, PowerN
- Standard, Series 556, PowerN
- Long, Series 557, PowerN

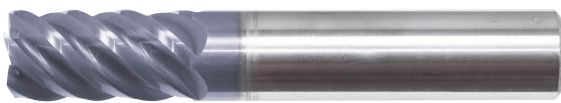

- Stub, Series 558, PowerN
- Standard, Series 556, PowerNR
- Long, Series 557, PowerNR



Length Key (K)



K	OD	LOC	SHK	OAL	Radius	PowerN		PowerNR	
	D1	L1	D2	L2	R	No Flat	With Flat	No Flat	With Flat
3	6	38	3	0.25	558-401-5	558-401W-5	558-401-8	558-401W-8	
			3	0.50	558-402-5	558-402W-5	558-402-8	558-402W-8	
			3	0.75	558-403-5	558-403W-5	558-403-8	558-403W-8	
			3	1.00	558-404-5	558-404W-5	558-404-8	558-404W-8	
			3	0.25	556-400-5	556-400W-5	556-400-8	556-400W-8	
			3	0.50	556-401-5	556-401W-5	556-401-8	556-401W-8	
			3	0.75	556-402-5	556-402W-5	556-402-8	556-402W-8	
			3	0.25	557-400-5	557-400W-5	557-400-8	557-400W-8	
			3	0.50	557-401-5	557-401W-5	557-401-8	557-401W-8	
			3	0.75	557-402-5	557-402W-5	557-402-8	557-402W-8	
			3	1.00	557-403-5	557-403W-5	557-403-8	557-403W-8	
			4	8	50	4	0.25	558-410-5	558-410W-5
4	0.50	558-411-5				558-411W-5	558-411-8	558-411W-8	
4	0.75	558-412-5				558-412W-5	558-412-8	558-412W-8	
4	1.00	558-413-5				558-413W-5	558-413-8	558-413W-8	
4	0.25	556-420-5				556-420W-5	556-420-8	556-420W-8	
4	0.50	556-421-5				556-421W-5	556-421-8	556-421W-8	
4	0.75	556-422-5				556-422W-5	556-422-8	556-422W-8	
4	1.00	556-423-5				556-423W-5	556-423-8	556-423W-8	
4	0.25	557-410-5				557-410W-5	557-410-8	557-410W-8	
4	0.50	557-411-5				557-411W-5	557-411-8	557-411W-8	
4	0.75	557-412-5				557-412W-5	557-412-8	557-412W-8	
4	1.00	557-413-5				557-413W-5	557-413-8	557-413W-8	
5	10	50	5	0.25	558-420-5	558-420W-5	558-420-8	558-420W-8	
			5	0.50	558-421-5	558-421W-5	558-421-8	558-421W-8	
			5	0.75	558-422-5	558-422W-5	558-422-8	558-422W-8	
			5	1.00	558-423-5	558-423W-5	558-423-8	558-423W-8	
			5	0.25	556-440-5	556-440W-5	556-440-8	556-440W-8	
			5	0.50	556-441-5	556-441W-5	556-441-8	556-441W-8	
			5	0.75	556-442-5	556-442W-5	556-442-8	556-442W-8	
			5	1.00	556-443-5	556-443W-5	556-443-8	556-443W-8	

We manufacture a full range of cutting diameters and endcut radii. Please call for availability. 我们生产全系列的切割直径。请致电查询空房情况。

HY5 PRO+ CORNER RADIUS

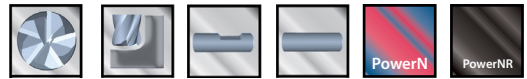

HY5 超倒R角铣刀

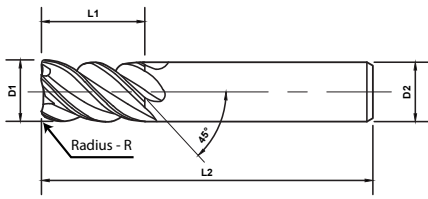

Length Key (K)

Standard Stub Long



K	OD	LOC	SHK	OAL	Radius	PowerN		PowerNR	
	D1	L1	D2	L2	R	No Flat	With Flat	No Flat	With Flat
5	20	20	5	75	0.25	557-420-5	557-420W-5	557-420-8	557-420W-8
		20	5	75	0.50	557-422-5	557-422W-5	557-422-8	557-422W-8
		20	5	75	0.75	557-423-5	557-423W-5	557-423-8	557-423W-8
		20	5	75	1.00	557-424-5	557-424W-5	557-424-8	557-424W-8
6	12	6	50	0.25	558-430-5	558-430W-5	558-430-8	558-430W-8	
		6	50	0.50	558-431-5	558-431W-5	558-431-8	558-431W-8	
		6	50	0.75	558-432-5	558-432W-5	558-432-8	558-432W-8	
		6	50	1.00	558-433-5	558-433W-5	558-433-8	558-433W-8	
		6	50	1.25	558-434-5	558-434W-5	558-434-8	558-434W-8	
		6	50	1.50	558-435-5	558-435W-5	558-435-8	558-435W-8	
		6	50	2.00	558-436-5	558-436W-5	558-436-8	558-436W-8	
		6	63	0.25	556-460-5	556-460W-5	556-460-8	556-460W-8	
		6	63	0.50	556-461-5	556-461W-5	556-461-8	556-461W-8	
		6	63	0.75	556-462-5	556-462W-5	556-462-8	556-462W-8	
		6	63	1.00	556-463-5	556-463W-5	556-463-8	556-463W-8	
		6	63	1.25	556-464-5	556-464W-5	556-464-8	556-464W-8	
8	12	8	50	0.50	558-451-5	558-451W-5	558-451-8	558-451W-8	
		8	50	0.75	558-452-5	558-452W-5	558-452-8	558-452W-8	
		8	50	1.00	558-453-5	558-453W-5	558-453-8	558-453W-8	
		8	50	1.25	558-454-5	558-454W-5	558-454-8	558-454W-8	
		8	50	1.50	558-455-5	558-455W-5	558-455-8	558-455W-8	
		8	50	2.00	558-456-5	558-456W-5	558-456-8	558-456W-8	
		8	50	3.00	558-457-5	558-457W-5	558-457-8	558-457W-8	
		8	63	0.50	556-471-5	556-471W-5	556-471-8	556-471W-8	
		8	63	0.75	556-472-5	556-472W-5	556-472-8	556-472W-8	
		8	63	1.00	556-473-5	556-473W-5	556-473-8	556-473W-8	
		8	63	1.25	556-474-5	556-474W-5	556-474-8	556-474W-8	
		8	63	1.50	556-475-5	556-475W-5	556-475-8	556-475W-8	
8	19	8	63	2.00	556-476-5	556-476W-5	556-476-8	556-476W-8	
		8	63	3.00	556-477-5	556-477W-5	556-477-8	556-477W-8	
		8	75	0.50	557-441-5	557-441W-5	557-441-8	557-441W-8	
		8	75	0.75	557-442-5	557-442W-5	557-442-8	557-442W-8	
		8	75	1.00	557-443-5	557-443W-5	557-443-8	557-443W-8	
		8	75	1.25	557-444-5	557-444W-5	557-444-8	557-444W-8	
		8	75	1.50	557-445-5	557-445W-5	557-445-8	557-445W-8	
		8	75	2.00	557-446-5	557-446W-5	557-446-8	557-446W-8	
		8	75	3.00	557-447-5	557-447W-5	557-447-8	557-447W-8	

We manufacture a full range of cutting diameters and endcut radii. Please call for availability.
我们生产全系列的切割直径。请致电查询空房情况。

HY5 PRO+ CORNER RADIUS

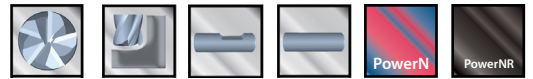

HY5 超倒R角铣刀

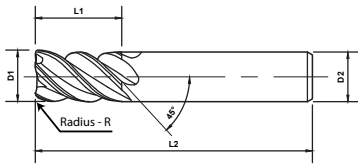

Length Key (K)



K	OD	LOC	SHK	OAL	Radius	PowerN		PowerNR				
	D1	L1	D2	L2	R	No Flat	With Flat	No Flat	With Flat			
10	14	10	10	50	0.50	558-461-5	558-461W-5	558-461-8	558-461W-8			
					0.75	558-462-5	558-462W-5	558-462-8	558-462W-8			
					1.00	558-463-5	558-463W-5	558-463-8	558-463W-8			
					1.25	558-464-5	558-464W-5	558-464-8	558-464W-8			
					1.50	558-465-5	558-465W-5	558-465-8	558-465W-8			
					2.00	558-466-5	558-466W-5	558-466-8	558-466W-8			
					3.00	558-467-5	558-467W-5	558-467-8	558-467W-8			
					22	10	70	0.50	556-481-5	556-481W-5	556-481-8	556-481W-8
								0.75	556-482-5	556-482W-5	556-482-8	556-482W-8
								1.00	556-483-5	556-483W-5	556-483-8	556-483W-8
								1.25	556-484-5	556-484W-5	556-484-8	556-484W-8
								1.50	556-485-5	556-485W-5	556-485-8	556-485W-8
								2.00	556-486-5	556-486W-5	556-486-8	556-486W-8
					38	10	100	0.50	557-451-5	557-451W-5	557-451-8	557-451W-8
								0.75	557-452-5	557-452W-5	557-452-8	557-452W-8
								1.00	557-453-5	557-453W-5	557-453-8	557-453W-8
								1.25	557-454-5	557-454W-5	557-454-8	557-454W-8
								1.50	557-455-5	557-455W-5	557-455-8	557-455W-8
								2.00	557-456-5	557-456W-5	557-456-8	557-456W-8
								3.00	557-457-5	557-457W-5	557-457-8	557-457W-8
12	16	12	0.50	558-471-5				558-471W-5	558-471-8	558-471W-8		
			0.75	558-472-5	558-472W-5	558-472-8	558-472W-8					
			1.00	558-473-5	558-473W-5	558-473-8	558-473W-8					
			1.25	558-474-5	558-474W-5	558-474-8	558-474W-8					
			1.50	558-475-5	558-475W-5	558-475-8	558-475W-8					
			2.00	558-476-5	558-476W-5	558-476-8	558-476W-8					
			3.00	558-477-5	558-477W-5	558-477-8	558-477W-8					
			4.00	558-478-5	558-478W-5	558-478-8	558-478W-8					
			25	12	75	0.50	556-491-5	556-491W-5	556-491-8	556-491W-8		
						0.75	556-492-5	556-492W-5	556-492-8	556-492W-8		
						1.00	556-493-5	556-493W-5	556-493-8	556-493W-8		
						1.25	556-494-5	556-494W-5	556-494-8	556-494W-8		
						1.50	556-495-5	556-495W-5	556-495-8	556-495W-8		
						2.00	556-496-5	556-496W-5	556-496-8	556-496W-8		
50	12	100	0.50	557-461-5	557-461W-5	557-461-8	557-461W-8					
			0.75	557-462-5	557-462W-5	557-462-8	557-462W-8					
			1.00	557-463-5	557-463W-5	557-463-8	557-463W-8					
			1.25	557-464-5	557-464W-5	557-464-8	557-464W-8					
			1.50	557-465-5	557-465W-5	557-465-8	557-465W-8					
			2.00	557-466-5	557-466W-5	557-466-8	557-466W-8					
			3.00	557-467-5	557-467W-5	557-467-8	557-467W-8					
			4.00	557-468-5	557-468W-5	557-468-8	557-468W-8					

We manufacture a full range of cutting diameters and endcut radii. Please call for availability. 我们生产全系列的切割直径。请致电查询空房情况。



HY5 PRO+ CORNER RADIUS

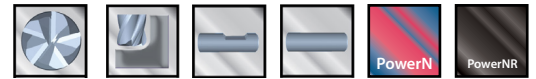

HY5 超 倒R角铣刀

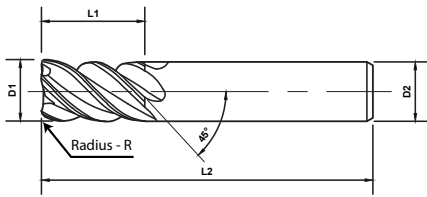

Length Key (K)

Standard Stub Long



K	OD	LOC	SHK	OAL	Radius	PowerN		PowerNR					
	D1	L1	D2	L2	R	No Flat	With Flat	No Flat	With Flat				
14	25	14	88	88	0.50	556-501-5	556-501W-5	556-501-8	556-501W-8				
					0.75	556-502-5	556-502W-5	556-502-8	556-502W-8				
					1.00	556-503-5	556-503W-5	556-503-8	556-503W-8				
					1.50	556-505-5	556-505W-5	556-505-8	556-505W-8				
					2.00	556-506-5	556-506W-5	556-506-8	556-506W-8				
					3.00	556-507-5	556-507W-5	556-507-8	556-507W-8				
					4.00	556-508-5	556-508W-5	556-508-8	556-508W-8				
					56	14	125	125	0.50	557-471-5	557-471W-5	557-471-8	557-471W-8
									0.75	557-472-5	557-472W-5	557-472-8	557-472W-8
									1.00	557-473-5	557-473W-5	557-473-8	557-473W-8
									1.50	557-475-5	557-475W-5	557-475-8	557-475W-8
									2.00	557-476-5	557-476W-5	557-476-8	557-476W-8
									3.00	557-477-5	557-477W-5	557-477-8	557-477W-8
									4.00	557-478-5	557-478W-5	557-478-8	557-478W-8
16	32	16	88	88	0.50	556-511-5	556-511W-5	556-511-8	556-511W-8				
					0.75	556-512-5	556-512W-5	556-512-8	556-512W-8				
					1.00	556-513-5	556-513W-5	556-513-8	556-513W-8				
					1.50	556-515-5	556-515W-5	556-515-8	556-515W-8				
					2.00	556-516-5	556-516W-5	556-516-8	556-516W-8				
					3.00	556-517-5	556-517W-5	556-517-8	556-517W-8				
					4.00	556-518-5	556-518W-5	556-518-8	556-518W-8				
					56	16	150	150	0.50	557-481-5	557-481W-5	557-481-8	557-481W-8
									0.75	557-482-5	557-482W-5	557-482-8	557-482W-8
									1.00	557-483-5	557-483W-5	557-483-8	557-483W-8
									1.50	557-485-5	557-485W-5	557-485-8	557-485W-8
									2.00	557-486-5	557-486W-5	557-486-8	557-486W-8
									3.00	557-487-5	557-487W-5	557-487-8	557-487W-8
									4.00	557-488-5	557-488W-5	557-488-8	557-488W-8
18	36	18	100	100	0.50	556-521-5	556-521W-5	556-521-8	556-521W-8				
					0.75	556-522-5	556-522W-5	556-522-8	556-522W-8				
					1.00	556-523-5	556-523W-5	556-523-8	556-523W-8				
					1.50	556-525-5	556-525W-5	556-525-8	556-525W-8				
					2.00	556-526-5	556-526W-5	556-526-8	556-526W-8				
					3.00	556-527-5	556-527W-5	556-527-8	556-527W-8				
					4.00	556-528-5	556-528W-5	556-528-8	556-528W-8				
					56	18	150	150	0.50	557-491-5	557-491W-5	557-491-8	557-491W-8
									0.75	557-492-5	557-492W-5	557-492-8	557-492W-8
									1.00	557-493-5	557-493W-5	557-493-8	557-493W-8
									1.50	557-495-5	557-495W-5	557-495-8	557-495W-8
									2.00	557-496-5	557-496W-5	557-496-8	557-496W-8
									3.00	557-497-5	557-497W-5	557-497-8	557-497W-8
									4.00	557-498-5	557-498W-5	557-498-8	557-498W-8

We manufacture a full range of cutting diameters and endcut radii. Please call for availability. 我们生产全系列的切割直径。请致电查询空房情况。

HY5 PRO+ CORNER RADIUS

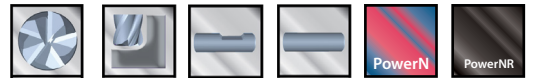

HY5 超倒R角铣刀

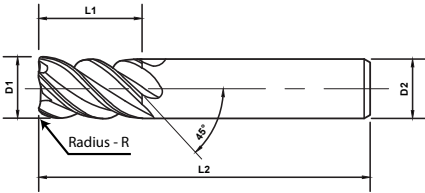

PRO+ PERFORMANCE ENDMILLS

Length Key (K)

Standard Stub Long



K	OD	LOC	SHK	OAL	Radius	PowerN		PowerNR						
	D1	L1	D2	L2	R	No Flat	With Flat	No Flat	With Flat					
20	38	20	20	100	0.50	556-531-5	556-531W-5	556-531-8	556-531W-8					
					0.75	556-532-5	556-532W-5	556-532-8	556-532W-8					
					1.00	556-533-5	556-533W-5	556-533-8	556-533W-8					
					1.50	556-535-5	556-535W-5	556-535-8	556-535W-8					
					2.00	556-536-5	556-536W-5	556-536-8	556-536W-8					
					3.00	556-537-5	556-537W-5	556-537-8	556-537W-8					
		20	150	20	150	0.50	556-538-5	556-538W-5	556-538-8	556-538W-8				
						0.75	556-539-5	556-539W-5	556-539-8	556-539W-8				
						1.00	557-501-5	557-501W-5	557-501-8	557-501W-8				
						1.50	557-502-5	557-502W-5	557-502-8	557-502W-8				
						2.00	557-503-5	557-503W-5	557-503-8	557-503W-8				
						3.00	557-505-5	557-505W-5	557-505-8	557-505W-8				
		20	150	20	150	4.00	557-506-5	557-506W-5	557-506-8	557-506W-8				
						5.00	557-507-5	557-507W-5	557-507-8	557-507W-8				
						4.00	557-508-5	557-508W-5	557-508-8	557-508W-8				
						5.00	557-509-5	557-509W-5	557-509-8	557-509W-8				
						25	38	25	100	0.50	556-541-5	556-541W-5	556-541-8	556-541W-8
										0.75	556-542-5	556-542W-5	556-542-8	556-542W-8
1.00	556-543-5	556-543W-5	556-543-8	556-543W-8										
1.50	556-545-5	556-545W-5	556-545-8	556-545W-8										
2.00	556-546-5	556-546W-5	556-546-8	556-546W-8										
3.00	556-547-5	556-547W-5	556-547-8	556-547W-8										
25	150	25	150	4.00	556-548-5			556-548W-5	556-548-8	556-548W-8				
				5.00	556-549-5			556-549W-5	556-549-8	556-549W-8				
				0.50	557-511-5			557-511W-5	557-511-8	557-511W-8				
				0.75	557-512-5			557-512W-5	557-512-8	557-512W-8				
				1.00	557-513-5			557-513W-5	557-513-8	557-513W-8				
				1.50	557-515-5			557-515W-5	557-515-8	557-515W-8				
25	150	25	150	2.00	557-516-5	557-516W-5	557-516-8	557-516W-8						
				3.00	557-517-5	557-517W-5	557-517-8	557-517W-8						
				4.00	557-518-5	557-518W-5	557-518-8	557-518W-8						
				5.00	557-519-5	557-519W-5	557-519-8	557-519W-8						

We manufacture a full range of cutting diameters and endcut radii. Please call for availability. 我们生产全系列的切割直径。请致电查询空房情况。



F45 PRO+ SQUARE ENDMILLS

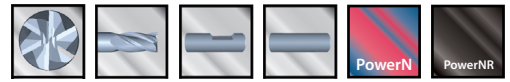

F45, 超 6刃平底铣刀

6 Flutes	Coated	Unique 45° 6 flute design, superior coating and edge quality
6刃	涂层	独特的45°6长笛设计，卓越的涂层和边缘质量

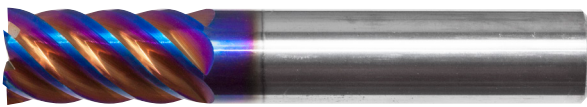
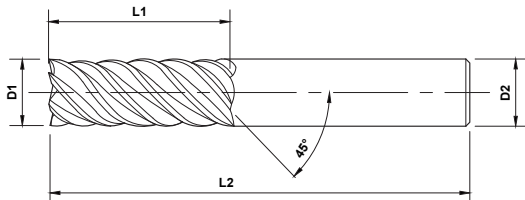

Standard, Series 559, PowerN

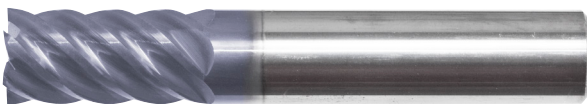

Standard, Series 559, PowerNR

Length Key (K)

Standard (dark blue), Stub (light blue), Long (black)



	OD	LOC	SHK	OAL	PowerN	PowerNR
K	D1	L1	D2	L2		
	5	16	5	50	559-002-5	559-002-8
	6	19	6	63	559-004-5	559-004-8
	7	19	8	63	559-006-5	559-006-8
	8	21	8	63	559-008-5	559-008-8
	9	22	10	70	559-010-5	559-010-8
	10	25	10	70	559-012-5	559-012-8
	11	25	11	70	559-014-5	559-014-8
	12	25	12	75	559-016-5	559-016-8
	14	30	14	88	559-018-5	559-018-8
	16	32	16	88	559-020-5	559-020-8
	18	35	18	100	559-022-5	559-022-8
	20	38	20	100	559-024-5	559-024-8
	22	38	22	100	559-026-5	559-026-8
	25	38	25	100	559-028-5	559-028-8

We manufacture a full range of cutting diameters. Please call for availability.
我们生产全系列的切割直径。请致电查询空房情况。

F45 PRO+ CORNER RADIUS

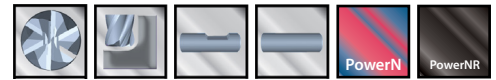

F45, 超 6刃倒R角铣刀

6 Flutes	Coated	Unique 45° 6 flute design, superior coating and edge quality
6刃	涂层	独特的45°6长笛设计, 卓越的涂层和边缘质量

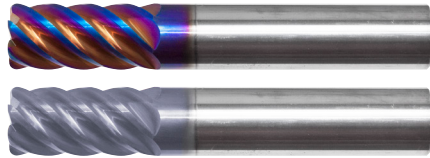

Standard, Series 559, PowerN

Standard, Series 559, PowerNR

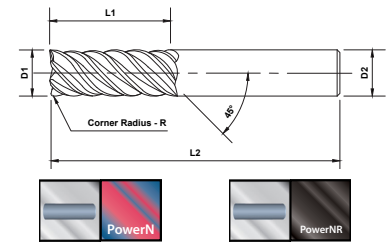

	OD	LOC	SHK	OAL	Radius	PowerN	PowerNR
K	D1	L1	D2	L2	R		
	6	19	6	63	0.25	559-210-5	559-210-8
	7	19	8	63	0.25	559-220-5	559-220-8
	8	21	8	63	0.25	559-230-5	559-230-8
	9	22	10	70	0.50	559-241-5	559-241-8
	10	25	10	70	0.50	559-251-5	559-251-8
	11	25	11	70	0.50	559-261-5	559-261-8
	12	25	12	75	0.50	559-271-5	559-271-8
	14	30	14	88	0.50	559-281-5	559-281-8
	16	32	16	88	0.50	559-291-5	559-291-8
	18	35	18	100	1.00	559-303-5	559-303-8
	20	38	20	100	1.00	559-313-5	559-313-8
	22	38	22	100	1.00	559-323-5	559-323-8
	25	38	25	100	1.25	559-334-5	559-334-8

We manufacture a full range of cutting diameters and endcut radii. Please call for availability. 我们生产全系列的切割直径。请致电查询空房情况。

PRO+ PERFORMANCE ENDMILLS

V7 PRO+ ENDMILLS

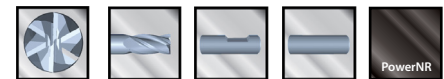

V7, 超

7 Flutes	Coated	Progressive Helix	Non-Center Cutting Design
7刃	涂层	渐进式螺旋	无中心切割设计

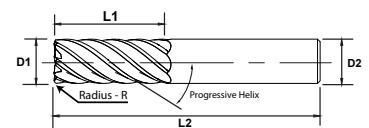

Standard, Series 449, PowerNR

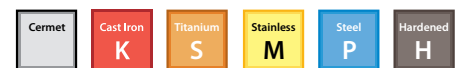

	OD	LOC	SHK	OAL	Square	.50mm Corner Radius	1mm Corner Radius	2mm Corner Radius	3mm Corner Radius	4mm Corner Radius
K	D1	L1	D2	L2						
	6	13	6	57	549-006-8	549-421-8	549-423-8	549-426-8	-	-
	8	19	8	63	549-014-8	549-461-8	549-463-8	549-466-8	549-467-8	-
	10	19	10	63	549-020-8	549-491-8	549-493-8	549-496-8	549-497-8	549-498-8
	12	32	12	84	549-034-8	549-561-8	549-563-8	549-566-8	549-567-8	549-568-8
	16	42	16	92	549-046-8	549-621-8	549-623-8	549-626-8	549-627-8	549-628-8
	20	52	20	102	549-054-8	549-661-8	549-663-8	549-666-8	549-667-8	549-668-8

Available with Weldon Flat - Add **W** to part ID for Weldon flat 449-XXXW-8

CARBIDE DRILLS 硬质合金钻头

- **Jobber Drills** - 标准钻头系列
- **Stub Drills** - 短钻头系列
- **Straight Flute Drills** - 直刃钻头
- **Spade Drills** - 扁铲钻头
- **Spotting Drills** - 定位钻
- **Drill and Countersink** - 钻孔及沉孔钻
- **Multiple Flute Countersinks** - 多刃沉孔钻
- **Chamfer Tools** - 倒角刀

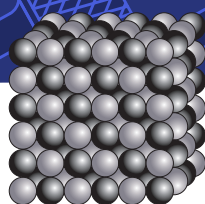

Mastercut's Superior Carbide Blend A-Gr-SiV (Active Grain Sized Volume)

Our superior tungsten carbide gives you the ability to be *aggressive* when you need to be. Growth inhibitors in our submicron carbide blanks maintain the most consistent grain size available, giving you superior hardness AND toughness.





迈斯卡的超级硬质合金材质 - A-Gr-SiV

迈斯卡的超级硬质合金材质 - 拥有均匀亚微米晶粒，完美的硬度和韧性的结合，保证我们的刀具可以面对各种挑战时游刃有余。



LEGEND

图示说明

Features • 产品特点

	2 Flutes 2刃		4 Flutes 4刃		Plain Shank 普通刀柄
	3 Flutes 3刃		6 Flutes 6刃		

Coatings • 涂层

	PowerA PowerA (Aluminum Titanium Nitride AlTiN)		Uncoated 无涂层
---	--	---	-----------------



Mastercut's Superior Carbide Blend – A-Gr-SiV (Active Grain Sized Volume)

Our superior tungsten carbide gives you the ability to be *aggressive* when you need to be. Growth inhibitors in our submicron carbide blanks maintain the most consistent grain size available, giving you superior hardness and toughness.

迈斯卡的超级硬质合金材质 - A-Gr-SiV

迈斯卡的超级硬质合金材质 - 拥有均匀亚微米晶粒，完美的硬度和韧性的结合，保证我们的刀具可以面对各种挑战时游刃有余。

TABLE OF CONTENTS - 目录

	2 Flute Jobber Drills 2刃118°四面尖 标准钻头.....	107	      
	3 Flute Jobber Drills 3刃130°高性能钻尖.....	108	      
	Stub Drills 短钻头.....	110	      
	Medium Length Drills 中长钻头.....	111	      
	Spade Drills 扁铲钻头.....	113	      
	NC Spotting Drills NC 定位钻.....	114	      
	Drill and Countersink / Center Drills 中心沉孔钻.....	115	      
	Countersinks, 1 Flute 沉孔钻 单刃.....	116	    
	Countersinks, 3 Flute 沉孔钻 三刀片.....	117	    
	Countersinks, 6 Flute 沉孔钻 六刀片.....	118	    
	Chamfer Tools 倒角刀.....	119	     

JOBBER DRILLS

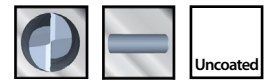

2刃118°四面尖 标准钻头



2 Flute	118° Four Facet Point	Uncoated
2刃	118°四面尖·无涂层	无涂层

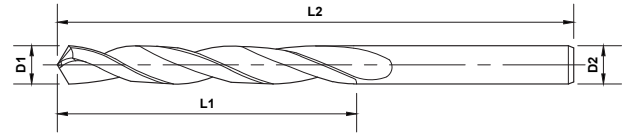

OD	LOC	SHK	OAL	Uncoated
D1	L1	D2	L2	
3	33	3	61	701-006
3.1	36	3.1	65	701-008
3.2	36	3.2	65	701-010
3.3	36	3.3	65	701-012
3.4	39	3.4	70	701-014
3.5	39	3.5	70	701-016
3.6	39	3.6	70	701-018
3.7	39	3.7	70	701-020
3.8	43	3.8	75	701-022
3.9	43	3.9	75	701-024
4	43	4	75	701-026
4.1	43	4.1	75	701-028
4.2	43	4.2	75	701-030
4.3	47	4.3	80	701-032
4.4	47	4.4	80	701-034
4.5	47	4.5	80	701-036
4.6	47	4.6	80	701-038
4.7	47	4.7	80	701-040
4.8	52	4.8	86	701-042
4.9	52	4.9	86	701-044
5	52	5	86	701-046
5.1	52	5.1	86	701-048
5.2	52	5.2	86	701-050
5.3	52	5.3	86	701-052
5.4	57	5.4	93	701-054
5.5	57	5.5	93	701-056
5.6	57	5.6	93	701-058
5.7	57	5.7	93	701-060
5.8	57	5.8	93	701-062
5.9	57	5.9	93	701-064
6	57	6	93	701-066
6.1	63	6.1	101	701-068
6.2	63	6.2	101	701-070
6.3	63	6.3	101	701-072
6.4	63	6.4	101	701-074
6.5	63	6.5	101	701-076
6.6	63	6.6	101	701-078
6.7	63	6.7	101	701-080
6.8	69	6.8	109	701-082
6.9	69	6.9	109	701-084

OD	LOC	SHK	OAL	Uncoated
D1	L1	D2	L2	
7	69	7	109	701-086
7.1	69	7.1	109	701-088
7.2	69	7.2	109	701-090
7.3	69	7.3	109	701-092
7.4	69	7.4	109	701-094
7.5	69	7.5	109	701-096
7.6	75	7.6	117	701-098
7.7	75	7.7	117	701-100
7.8	75	7.8	117	701-102
7.9	75	7.9	117	701-104
8	75	8	117	701-106
8.1	75	8.1	117	701-108
8.2	75	8.2	117	701-110
8.3	75	8.3	117	701-112
8.4	75	8.4	117	701-114
8.5	75	8.5	117	701-116
8.6	81	8.6	125	701-118
8.7	81	8.7	125	701-120
8.8	81	8.8	125	701-122
8.9	81	8.9	125	701-124
9	81	9	125	701-126
9.1	81	9.1	125	701-128
9.2	81	9.2	125	701-130
9.3	81	9.3	125	701-132
9.4	81	9.4	125	701-134
9.5	81	9.5	125	701-136
9.6	87	9.6	133	701-138
9.7	87	9.7	133	701-140
9.8	87	9.8	133	701-142
9.9	87	9.9	133	701-144
10	87	10	133	701-146
10.2	87	10.2	133	701-148
10.5	87	10.5	133	701-150
11	94	11	142	701-152
11.5	94	11.5	142	701-154
12	101	12	151	701-156
14.5	114	14.5	169	701-158
15	114	15	169	701-160
15.5	120	15.5	178	701-162

CARBIDE DRILLS

3 FLUTE JOBBER DRILLS

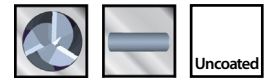

3 刃 130° 高性能钻尖

3 Flute	130° Four Facet Point	Uncoated
3刃	130°四面尖•无涂层	无涂层

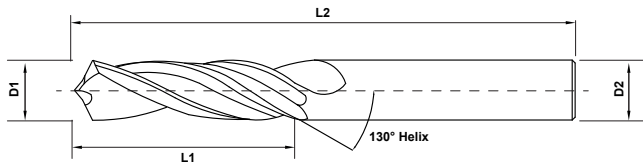

OD	LOC	SHK	OAL	Uncoated
D1	L1	D2	L2	
4	22	4	55	701-502
4.1	22	4.1	55	701-504
4.2	22	4.2	55	701-506
4.3	24	4.3	58	701-508
4.4	24	4.4	58	701-510
4.5	24	4.5	58	701-512
4.6	24	4.6	58	701-514
4.7	24	4.7	58	701-516
4.8	26	4.8	62	701-518
4.9	26	4.9	62	701-520
5	26	5	62	701-522
5.1	26	5.1	62	701-524
5.2	26	5.2	62	701-526
5.3	28	5.3	66	701-528
5.4	28	5.4	66	701-530
5.5	28	5.5	66	701-532
5.6	28	5.6	66	701-534
5.7	28	5.7	66	701-536
5.8	28	5.8	66	701-538
5.9	28	5.9	66	701-540
6	31	6	66	701-542
6.1	31	6.1	70	701-544
6.2	31	6.2	70	701-546
6.3	31	6.3	70	701-548
6.4	31	6.4	70	701-550



OD	LOC	SHK	OAL	Uncoated
D1	L1	D2	L2	
6.5	31	6.5	70	701-552
6.6	31	6.6	70	701-554
6.7	31	6.7	70	701-556
6.8	34	6.8	74	701-558
6.9	34	6.9	74	701-560
7	34	7	74	701-562
7.1	34	7.1	74	701-564
7.2	34	7.2	74	701-566
7.3	34	7.3	74	701-568
7.4	34	7.4	74	701-570
7.5	34	7.5	74	701-572
7.6	37	7.6	79	701-574
7.7	37	7.7	79	701-576
7.8	37	7.8	79	701-578
7.9	37	7.9	79	701-580
8	37	8	79	701-582
8.1	37	8.1	79	701-584
8.2	37	8.2	79	701-586
8.3	37	8.3	79	701-588
8.4	37	8.4	79	701-590
8.5	37	8.5	79	701-592
8.6	40	8.6	84	701-594
8.7	40	8.7	84	701-596
8.8	40	8.8	84	701-598
8.9	40	8.9	84	701-600

3 FLUTE JOBBER DRILLS

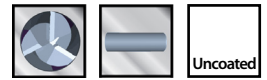

3 刃 130° 高性能钻头



CARBIDE DRILLS



OD	LOC	SHK	OAL	Uncoated
D1	L1	D2	L2	
9	40	9	84	701-602
9.1	40	9.1	84	701-604
9.2	40	9.2	84	701-606
9.3	40	9.3	84	701-608
9.4	40	9.4	84	701-610
9.5	40	9.5	84	701-612
9.6	43	9.6	89	701-614
9.7	43	9.7	89	701-616
9.8	43	9.8	89	701-618
9.9	43	9.9	89	701-620
10	43	10	89	701-622
10.1	43	10.1	89	701-624
10.2	43	10.2	89	701-626
10.3	43	10.3	89	701-628
10.4	43	10.4	89	701-630
10.5	43	10.5	89	701-632
10.6	43	10.6	89	701-634
10.7	43	10.7	89	701-636
10.8	43	10.8	89	701-638
11	47	11	95	701-640

OD	LOC	SHK	OAL	Uncoated
D1	L1	D2	L2	
11.2	47	11.2	95	701-642
11.5	47	11.5	95	701-644
11.8	47	11.8	95	701-646
12	51	12	102	701-648
12.5	51	12.5	102	701-650
13	51	13	102	701-652
13.5	51	13.5	102	701-654
14	54	14	107	701-656
14.5	56	14.5	111	701-658
15	56	15	111	701-660
15.5	58	15.5	115	701-662
16	58	16	115	701-664
16.5	60	16.5	119	701-666
17	60	17	119	701-668
17.5	62	17.5	123	701-670
18	62	18	123	701-672
18.5	64	18.5	127	701-674
19	64	19	127	701-676
19.5	66	19.5	131	701-678
20	66	20	131	701-680

STUB DRILLS

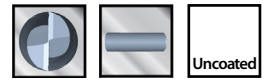

短钻头

2 Flute	118° Four Facet Point	Uncoated
2刃	118°4面尖	无涂层

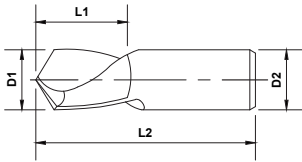

Uncoated



OD	LOC	SHK	OAL	Uncoated
D1	L1	D2	L2	
3	12	3	46	703-002
3.1	14	3.1	49	703-004
3.2	14	3.2	49	703-006
3.3	14	3.3	49	703-008
3.4	15	3.4	52	703-010
3.5	15	3.5	52	703-012
3.6	15	3.6	52	703-014
3.7	15	3.7	52	703-016
3.8	17	3.8	55	703-018
3.9	17	3.9	55	703-020
4	17	4	55	703-022
4.1	17	4.1	55	703-024
4.2	17	4.2	55	703-026
4.3	18	4.3	58	703-028
4.4	18	4.4	58	703-030
4.5	18	4.5	58	703-032
4.6	18	4.6	58	703-034
4.7	18	4.7	58	703-036
4.8	20	4.8	62	703-038
4.9	20	4.9	62	703-040
5	20	5	62	703-042
5.1	20	5.1	62	703-044
5.2	20	5.2	62	703-046
5.3	20	5.3	62	703-048
5.4	21	5.4	66	703-050
5.5	21	5.5	66	703-052
5.6	21	5.6	66	703-054

OD	LOC	SHK	OAL	Uncoated
D1	L1	D2	L2	
5.7	21	5.7	66	703-056
5.8	21	5.8	66	703-058
5.9	21	5.9	66	703-060
6	21	6	66	703-062
6.1	23	6.1	70	703-064
6.2	23	6.2	70	703-066
6.3	23	6.3	70	703-068
6.4	23	6.4	70	703-070
6.5	23	6.5	70	703-072
6.8	23	6.8	70	703-074
6.9	23	6.9	70	703-076
7	25	7	74	703-078
7.5	25	7.5	74	703-080
8	27	8	79	703-082
8.5	27	8.5	79	703-084
9	29	9	84	703-086
9.5	29	9.5	84	703-088
9.6	29	9.6	84	703-090
10	31	10	89	703-092
10.5	31	10.5	89	703-094
11	33	11	95	703-096
11.5	33	11.5	95	703-098
12	35	12	102	703-100
12.5	35	12.5	102	703-102
13	35	13	102	703-104
14	37	14	107	703-106

MEDIUM LENGTH DRILLS

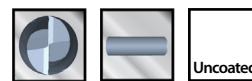

中长钻头

2 Flute	118° Four Facet Point	Uncoated
2刃	118°4面尖	无涂层

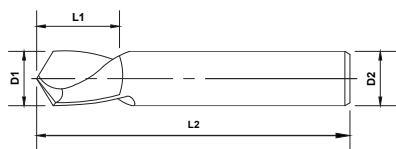

Uncoated



OD	LOC	SHK	OAL	Uncoated
D1	L1	D2	L2	
3	16	3	46	703-502
3.1	16	3.1	46	703-504
3.2	18	3.2	49	703-506
3.3	18	3.3	49	703-508
3.4	20	3.4	52	703-510
3.5	20	3.5	52	703-512
3.6	20	3.6	52	703-514
3.7	20	3.7	52	703-516
3.8	22	3.8	55	703-518
3.9	22	3.9	55	703-520
4	22	4	55	703-522
4.1	22	4.1	55	703-524
4.2	22	4.2	55	703-526
4.3	24	4.3	58	703-528
4.4	24	4.4	58	703-530
4.5	24	4.5	58	703-532
4.6	24	4.6	58	703-534
4.7	24	4.7	58	703-536
4.8	26	4.8	62	703-538
4.9	26	4.9	62	703-540
5	26	5	62	703-542
5.1	26	5.1	62	703-544
5.2	26	5.2	62	703-546
5.3	26	5.3	62	703-548



OD	LOC	SHK	OAL	Uncoated
D1	L1	D2	L2	
5.4	28	5.4	66	703-550
5.5	28	5.5	66	703-552
5.6	28	5.6	66	703-554
5.7	28	5.7	66	703-556
5.8	28	5.8	66	703-558
5.9	28	5.9	66	703-560
6	28	6	66	703-562
6.1	31	6.1	70	703-564
6.2	31	6.2	70	703-566
6.3	31	6.3	70	703-568
6.4	31	6.4	70	703-570
6.5	31	6.5	70	703-572
6.6	31	6.6	70	703-574
6.7	31	6.7	70	703-576
6.8	34	6.8	74	703-578
6.9	34	6.9	74	703-580
7	34	7	74	703-582
7.1	34	7.1	74	703-584
7.2	34	7.2	74	703-586
7.3	34	7.3	74	703-588
7.4	34	7.4	74	703-590
7.5	34	7.5	74	703-592
7.6	37	7.6	79	703-594
7.7	37	7.7	79	703-596

CARBIDE DRILLS

MEDIUM LENGTH DRILLS

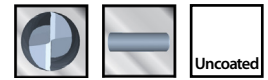

中长钻头



OD	LOC	SHK	OAL	Uncoated
D1	L1	D2	L2	
7.8	37	7.8	79	703-598
7.9	37	7.9	79	703-600
8	37	8	79	703-602
8.1	37	8.1	79	703-604
8.2	37	8.2	79	703-606
8.3	37	8.3	79	703-608
8.4	37	8.4	79	703-610
8.5	37	8.5	79	703-612
8.6	40	8.6	84	703-614
8.7	40	8.7	84	703-616
8.8	40	8.8	84	703-618
8.9	40	8.9	84	703-620
9	40	9	84	703-622
9.1	40	9.1	84	703-624
9.2	40	9.2	84	703-626
9.3	40	9.3	84	703-628
9.4	40	9.4	84	703-630
9.5	40	9.5	84	703-632
9.6	43	9.6	89	703-634
9.7	43	9.7	89	703-636
9.8	43	9.8	89	703-638
9.9	43	9.9	89	703-640
10	43	10	89	703-642
10.1	43	10.1	89	703-644
10.2	43	10.2	89	703-646
10.3	43	10.3	89	703-648



OD	LOC	SHK	OAL	Uncoated
D1	L1	D2	L2	
10.4	43	10.4	89	703-650
10.5	43	10.5	89	703-652
10.6	43	10.6	89	703-654
10.7	43	10.7	89	703-656
10.8	43	10.8	89	703-658
11	47	11	95	703-660
11.2	47	11.2	95	703-662
11.5	47	11.5	95	703-664
11.8	47	11.8	95	703-666
12	51	12	102	703-668
12.5	51	12.5	102	703-670
13	51	13	102	703-672
13.5	51	13.5	102	703-674
14	56	14	111	703-676
14.5	56	14.5	111	703-678
15	56	15	111	703-680
15.5	58	15.5	115	703-682
16	58	16	115	703-684
16.5	60	16.5	119	703-686
17	60	17	119	703-688
17.5	62	17.5	123	703-690
18	62	18	123	703-692
18.5	64	18.5	127	703-694
19	64	19	127	703-696
19.5	66	19.5	131	703-698
20	66	20	131	703-700

SPADE DRILLS

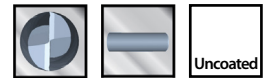

扁铲钻头

2 Flute	118° Point	Uncoated
2刃	118°尖	无涂层

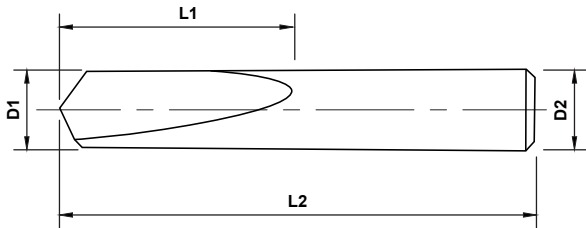

Uncoated

CARBIDE DRILLS

OD	LOC	SHK	OAL	Uncoated
D1	L1	D2	L2	
3	12	3	38	700-002
4	17	4	50	700-004
6	16	6	50	700-006
8	22	8	63	700-008
10	28	10	63	700-010
12	32	12	75	700-012

NC SPOTTING DRILLS

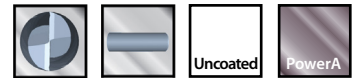

NC 定位钻

2 Flute	90°, 120° point	Coated and Uncoated
2刃	90°, 120°	涂层和无涂层

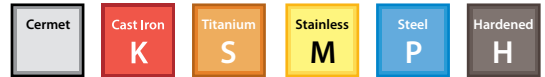
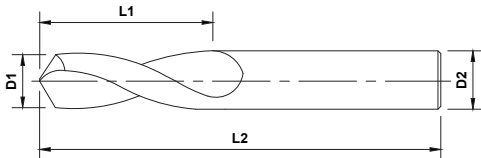

Uncoated



OD	LOC	SHK	OAL	Uncoated		PowerA	
				90°	120°	90°	120°
3	10	3	38	700-402	700-502	700-402-1	700-502-1
4	18	4	63	700-404	700-504	700-404-1	700-504-1
6	20	6	63	700-406	700-506	700-406-1	700-506-1
8	20	8	63	700-408	700-510	700-408-1	700-510-1
10	25	10	75	700-410	700-512	700-410-1	700-512-1
12	25	12	75	700-412	700-514	700-412-1	700-514-1

DRILL AND COUNTERSINK

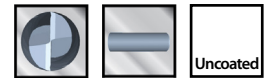

中心沉孔钻

2 Flute	118° point Center Drills • 60°, 82° and 90° Countersink	Uncoated
2刃	118°中心钻, 60°, 82° and 90° 沉孔	无涂层

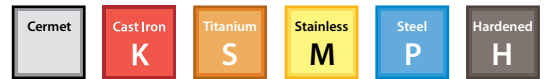
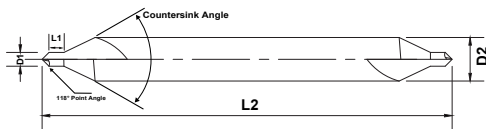

CARBIDE DRILLS



Uncoated

Quick Ship Items

OD	LOC	SHK	OAL	Uncoated		
				60°	82°	90°
D1	L1	D2	L2			
1.2	1.2	3.18	38	700-302	700-102	700-202
2	2	4.75	50	700-304	700-104	700-204
2.8	2.8	6.3	50	700-306	700-106	700-206
3.15	3.15	8	56	700-308	700-108	700-208
4	4	11.1	70	700-310	700-110	700-210
5	5	12.7	75	700-312	700-112	700-212
6	6	15.9	81	700-314	700-114	700-214
8	8	19	85	700-316	700-116	700-216

COUNTERSINKS - 1 FLUTE

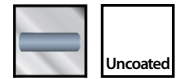

沉孔钻 单刃

1 Flute	60°, 82° and 90° countersinks	Uncoated
1刃	60°, 82° 和 90° 沉孔钻	无涂层

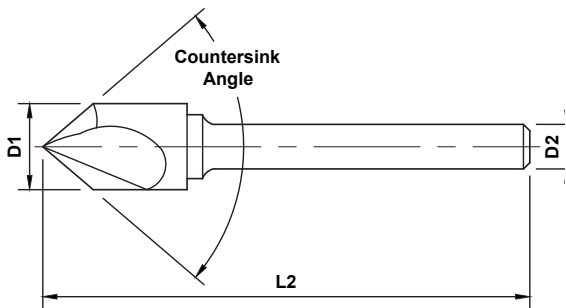

Uncoated

OD	SHK	OAL	Uncoated		
			60°	82°	90°
D1	D2	L2			
3	3	38	780-002 *	780-102 *	780-202 *
5	5	50	780-004 *	780-104 *	780-204 *
6	6	50	780-006 *	780-106 *	780-206 *
9.5	6	66	780-008	780-108	780-208
12.7	6	72	780-010	780-110	780-210
16	8	75	780-012	780-112	780-212
19	8	75	780-014	780-114	780-214
25	8	83	780-016	780-116	780-216

* Solid Carbide • *全然 碳化物

COUNTERSINKS - 3 FLUTE

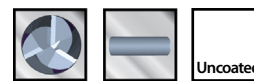

沉孔钻 三刀片

3 Flute	60°, 82° and 90° countersinks	Uncoated
3刃	60°, 82° 和 90° 沉孔钻	无涂层

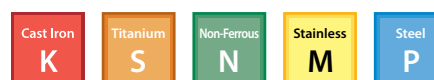
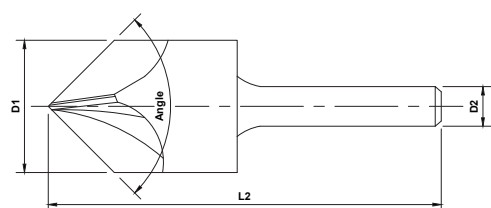

Uncoated

OD	SHK	OAL	Uncoated		
			60°	82°	90°
D1	D2	L2			
3	3	38	780-302 *	780-402 *	780-502 *
5	5	50	780-304 *	780-404 *	780-504 *
6	6	50	780-306 *	780-406 *	780-506 *
9.5	6	66	780-308	780-408	780-508
12.7	6	72	780-310	780-410	780-510
16	8	69	780-312	780-412	780-512
19	8	75	780-314	780-414	780-514
25	8	70	780-316	780-416	780-516

* Solid Carbide * 全 然 碳 化 物

COUNTERSINKS - 6 FLUTE

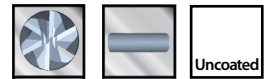

沉孔钻 六刀片

6 Flute	60°, 82° and 90° countersinks	Uncoated
6刃	60°, 82° 和 90° 沉孔钻	无涂层

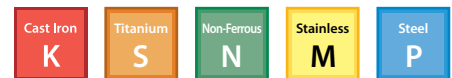
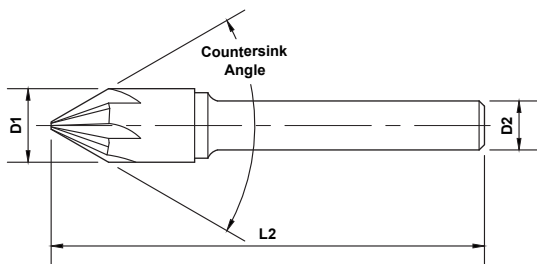

Uncoated



OD	SHK	OAL	Uncoated		
D1	D2	L2	60°	82°	90°
3	3	38	780-602 *	780-702 *	780-802 *
5	5	50	780-604 *	780-704 *	780-804 *
6	6	50	780-606 *	780-706 *	780-806 *
9.5	6	66	780-608	780-708	780-808
12.7	6	72	780-610	780-710	780-810
16	8	75	780-612	780-712	780-812
19	8	75	780-614	780-714	780-814
25	8	83	780-616	780-716	780-816

* Solid Carbide • *全然 碳化物

CHAMFER TOOLS



倒角刀

4 Flute	60°, 82° and 90°	Coated and Uncoated
4刃	60°, 82° 和 90°	无涂层

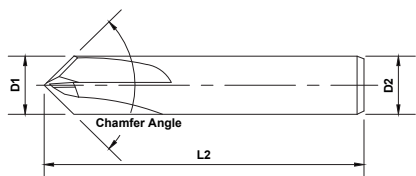

Uncoated

OD	SHK	OAL	Uncoated			PowerA		
			60°	82°	90°	60°	82°	90°
4	4	50	781-002	781-102	781-202	781-002-1	781-102-1	781-202-1
5	5	50	781-004	781-104	781-204	781-004-1	781-104-1	781-204-1
6	6	64	781-006	781-106	781-206	781-006-1	781-106-1	781-206-1
8	8	64	781-008	781-108	781-208	781-008-1	781-108-1	781-208-1
10	10	70	781-010	781-110	781-210	781-010-1	781-110-1	781-210-1
12	12	76	781-012	781-112	781-212	781-012-1	781-112-1	781-212-1

CARBIDE DRILLS

HIGH PERFORMANCE DRILLS 高性能钻头

Hurricane Drill Series

- **Non-Coolant Through -**

飓风系列高性能整体硬质合金钻头

- **Coolant Through -**

带中通冷却孔钻头

Coolant Through Hurricane Drills - 冷却孔钻



HURRICANE HIGH PERFORMANCE DRILL FEATURES

飓风高性能钻的特点



- High performance drill with a common shank
- Coolant Through and Non-Coolant Through styles available
- 3XD, 5XD, 8XD
- Uncoated and PowerA coating available
- Now also available in PowerNR coating (call for information)
- 标准刀杆
- 提供带中空冷却和无中空冷却两种设计
- 3x; 5x; 8x 倍径为标准长度
- 标配为涂层和PowerA涂层
- 现在也提供超级PowerNr涂层

TABLE OF CONTENTS - 目录



Hurricane Drill High Performance Features

飓风高性能钻的特点 121



Hurricane 3xD Non-Coolant & Coolant Through
3x倍径实心和中通冷却钻头 122



Hurricane 5xD Non-Coolant & Coolant Through
5x倍径实心和中通冷却钻头 127



Hurricane 8xD Coolant Through
8x倍径实心和中通冷却钻头 132



Features • 产品特点

	2 Flutes 2刃		Plain Shank 普通刀柄
	Non Coolant Through 2刃实心钻		Coolant Through 2刃中通冷却

Coatings • 涂层

	PowerA PowerA (Aluminum Titanium Nitride AlTiN)
	Uncoated 无涂层

HIGH PERFORMANCE DRILLS

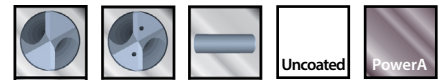

3x倍径实心和中通冷却钻头

3XD	Coated and Uncoated	2 FL, 140° Point and 30° Helix
3倍径	涂层和无涂层	2刃 140°角和30°螺旋

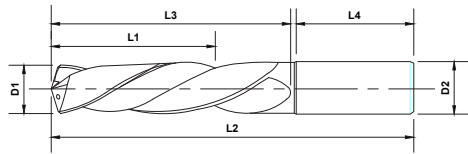

*Hurricane Drills
*飓风硬质合金钻头

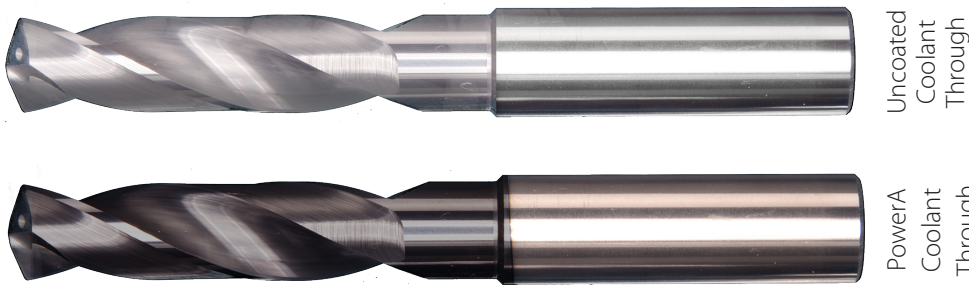

OD	LOC	LOF	SHK	SHK-L	OAL	Uncoated		PowerA	
						Non-Coolant Through	Coolant Through	Non-Coolant Through	Coolant Through
D1	L1	L3	D2	L4	L2				
3	14	20	6	36	62	750-002	-	750-002-1	-
3.1	14	20	6	36	62	750-004	-	750-004-1	-
3.17	14	20	6	36	62	750-006	-	750-006-1	-
3.2	14	20	6	36	62	750-010	-	750-010-1	-
3.25	14	20	6	36	62	750-012	-	750-012-1	-
3.3	14	20	6	36	62	750-014	-	750-014-1	-
3.4	14	20	6	36	62	750-016	750-516	750-016-1	750-516-1
3.5	14	20	6	36	62	750-018	750-518	750-018-1	750-518-1

* For extreme performance drilling, try our PowerNR coating, Use the uncoated part number and add -8.
*如需要超硬钻头,可选择我们的PowerNR涂层,编号为无涂层编号加“-8”

HIGH PERFORMANCE DRILLS

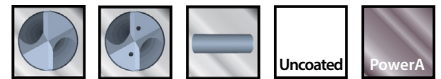

3x倍径实心和中通冷却钻头



OD	LOC	LOF	SHK	SHK-L	OAL	Uncoated		PowerA	
						Non-Coolant Through	Coolant Through	Non-Coolant Through	Coolant Through
D1	L1	L3	D2	L4	L2				
3.57	14	20	6	36	62	750-020	750-520	750-020-1	750-520-1
3.6	14	20	6	36	62	750-024	750-524	750-024-1	750-524-1
3.7	14	20	6	36	62	750-026	750-526	750-026-1	750-526-1
3.8	17	24	6	36	66	750-028	750-528	750-028-1	750-528-1
3.9	17	24	6	36	66	750-030	750-530	750-030-1	750-530-1
3.97	17	24	6	36	66	750-034	750-534	750-034-1	750-534-1
4	17	24	6	36	66	750-036	750-536	750-036-1	750-536-1
4.1	17	24	6	36	66	750-038	750-538	750-038-1	750-538-1
4.2	17	24	6	36	66	750-040	750-540	750-040-1	750-540-1
4.3	17	24	6	36	66	750-042	750-542	750-042-1	750-542-1
4.37	17	24	6	36	66	750-046	750-546	750-046-1	750-546-1
4.4	17	24	6	36	66	750-048	750-548	750-048-1	750-548-1
4.5	17	24	6	36	66	750-050	750-550	750-050-1	750-550-1
4.6	17	24	6	36	66	750-052	750-552	750-052-1	750-552-1
4.65	17	24	6	36	66	750-054	750-554	750-054-1	750-554-1
4.7	17	24	6	36	66	750-056	750-556	750-056-1	750-556-1
4.76	20	28	6	36	66	750-058	750-558	750-058-1	750-558-1
4.8	20	28	6	36	66	750-062	750-562	750-062-1	750-562-1
4.9	20	28	6	36	66	750-064	750-564	750-064-1	750-564-1
5	20	28	6	36	66	750-066	750-566	750-066-1	750-566-1
5.1	20	28	6	36	66	750-068	750-568	750-068-1	750-568-1
5.16	20	28	6	36	66	750-072	750-572	750-072-1	750-572-1
5.2	20	28	6	36	66	750-074	750-574	750-074-1	750-574-1
5.3	20	28	6	36	66	750-076	750-576	750-076-1	750-576-1
5.4	20	28	6	36	66	750-078	750-578	750-078-1	750-578-1
5.5	20	28	6	36	66	750-080	750-580	750-080-1	750-580-1
5.55	20	28	6	36	66	750-082	750-582	750-082-1	750-582-1
5.56	20	28	6	36	66	750-086	750-586	750-086-1	750-586-1
5.6	20	28	6	36	66	750-088	750-588	750-088-1	750-588-1
5.7	20	28	6	36	66	750-090	750-590	750-090-1	750-590-1
5.8	20	28	6	36	66	750-092	750-592	750-092-1	750-592-1
5.9	20	28	6	36	66	750-094	750-594	750-094-1	750-594-1
5.95	20	28	6	36	66	750-096	750-596	750-096-1	750-596-1

HIGH PERFORMANCE DRILLS



HIGH PERFORMANCE DRILLS

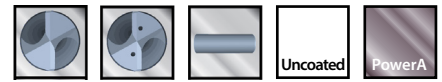

3x倍径实心和中通冷却钻头



OD	LOC	LOF	SHK	SHK-L	OAL	Uncoated		PowerA	
						Non-Coolant Through	Coolant Through	Non-Coolant Through	Coolant Through
D1	L1	L3	D2	L4	L2				
6	20	28	6	36	66	750-100	750-600	750-100-1	750-600-1
6.1	24	34	8	36	79	750-102	750-602	750-102-1	750-602-1
6.2	24	34	8	36	79	750-104	750-604	750-104-1	750-604-1
6.3	24	34	8	36	79	750-106	750-606	750-106-1	750-606-1
6.35	24	34	8	36	79	750-108	750-608	750-108-1	750-608-1
6.4	24	34	8	36	79	750-110	750-610	750-110-1	750-610-1
6.5	24	34	8	36	79	750-112	750-612	750-112-1	750-612-1
6.6	24	34	8	36	79	750-114	750-614	750-114-1	750-614-1
6.7	24	34	8	36	79	750-116	750-616	750-116-1	750-616-1
6.75	24	34	8	36	79	750-120	750-620	750-120-1	750-620-1
6.8	24	34	8	36	79	750-122	750-622	750-122-1	750-622-1
6.9	24	34	8	36	79	750-124	750-624	750-124-1	750-624-1
7	24	34	8	36	79	750-126	750-626	750-126-1	750-626-1
7.1	29	41	8	36	79	750-128	750-628	750-128-1	750-628-1
7.14	29	41	8	36	79	750-130	750-630	750-130-1	750-630-1
7.2	29	41	8	36	79	750-134	750-634	750-134-1	750-634-1
7.3	29	41	8	36	79	750-136	750-636	750-136-1	750-636-1
7.4	29	41	8	36	79	750-138	750-638	750-138-1	750-638-1
7.5	29	41	8	36	79	750-140	750-640	750-140-1	750-640-1
7.54	29	41	8	36	79	750-142	750-642	750-142-1	750-642-1
7.6	29	41	8	36	79	750-146	750-646	750-146-1	750-646-1
7.7	29	41	8	36	79	750-148	750-648	750-148-1	750-648-1
7.8	29	41	8	36	79	750-150	750-650	750-150-1	750-650-1
7.9	29	41	8	36	79	750-152	750-652	750-152-1	750-652-1
7.94	29	41	8	36	79	750-156	750-656	750-156-1	750-656-1
8	29	41	8	36	79	750-158	750-658	750-158-1	750-658-1
8.1	35	47	10	40	89	750-160	750-660	750-160-1	750-660-1
8.2	35	47	10	40	89	750-162	750-662	750-162-1	750-662-1
8.3	35	47	10	40	89	750-164	750-664	750-164-1	750-664-1
8.33	35	47	10	40	89	750-166	750-666	750-166-1	750-666-1
8.4	35	47	10	40	89	750-170	750-670	750-170-1	750-670-1
8.5	35	47	10	40	89	750-172	750-672	750-172-1	750-672-1
8.6	35	47	10	40	89	750-174	750-674	750-174-1	750-674-1

HIGH PERFORMANCE DRILLS

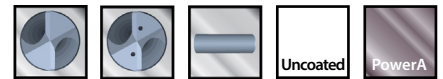

3x倍径实心和中通冷却钻头



OD	LOC	LOF	SHK	SHK-L	OAL	Uncoated		PowerA	
						Non-Coolant Through	Coolant Through	Non-Coolant Through	Coolant Through
D1	L1	L3	D2	L4	L2				
8.7	35	47	10	40	89	750-176	750-676	750-176-1	750-676-1
8.73	35	47	10	40	89	750-178	750-678	750-178-1	750-678-1
8.8	35	47	10	40	89	750-182	750-682	750-182-1	750-682-1
8.9	35	47	10	40	89	750-184	750-684	750-184-1	750-684-1
9	35	47	10	40	89	750-186	750-686	750-186-1	750-686-1
9.1	35	47	10	40	89	750-188	750-688	750-188-1	750-688-1
9.13	35	47	10	40	89	750-192	750-692	750-192-1	750-692-1
9.2	35	47	10	40	89	750-194	750-694	750-194-1	750-694-1
9.25	35	47	10	40	89	750-196	750-696	750-196-1	750-696-1
9.3	35	47	10	40	89	750-198	750-698	750-198-1	750-698-1
9.4	35	47	10	40	89	750-200	750-700	750-200-1	750-700-1
9.5	35	47	10	40	89	750-202	750-702	750-202-1	750-702-1
9.52	35	47	10	40	89	750-204	750-704	750-204-1	750-704-1
9.6	35	47	10	40	89	750-208	750-708	750-208-1	750-708-1
9.7	35	47	10	40	89	750-210	750-710	750-210-1	750-710-1
9.8	35	47	10	40	89	750-212	750-712	750-212-1	750-712-1
9.9	35	47	10	40	89	750-214	750-714	750-214-1	750-714-1
9.92	35	47	10	40	89	750-216	750-716	750-216-1	750-716-1
10	35	47	10	40	89	750-220	750-720	750-220-1	750-720-1
10.1	40	55	12	45	102	750-222	750-722	750-222-1	750-722-1
10.2	40	55	12	45	102	750-224	750-724	750-224-1	750-724-1
10.3	40	55	12	45	102	750-226	750-726	750-226-1	750-726-1
10.32	40	55	12	45	102	750-230	750-730	750-230-1	750-730-1
10.4	40	55	12	45	102	750-232	750-732	750-232-1	750-732-1
10.5	40	55	12	45	102	750-234	750-734	750-234-1	750-734-1
10.6	40	55	12	45	102	750-236	750-736	750-236-1	750-736-1
10.7	40	55	12	45	102	750-238	750-738	750-238-1	750-738-1
10.8	40	55	12	45	102	750-242	750-742	750-242-1	750-742-1
10.9	40	55	12	45	102	750-244	750-744	750-244-1	750-744-1
11	40	55	12	45	102	750-246	750-746	750-246-1	750-746-1
11.1	40	55	12	45	102	750-248	750-748	750-248-1	750-748-1
11.11	40	55	12	45	102	750-250	750-750	750-250-1	750-750-1

HIGH PERFORMANCE DRILLS



HIGH PERFORMANCE DRILLS

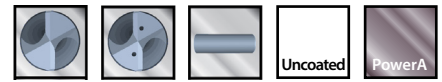

3x倍径实心和中通冷却钻头



OD	LOC	LOF	SHK	SHK-L	OAL	Uncoated		PowerA	
						Non-Coolant Through	Coolant Through	Non-Coolant Through	Coolant Through
D1	L1	L3	D2	L4	L2				
11.2	40	55	12	45	102	750-254	750-754	750-254-1	750-754-1
11.3	40	55	12	45	102	750-256	750-756	750-256-1	750-756-1
11.4	40	55	12	45	102	750-258	750-758	750-258-1	750-758-1
11.5	40	55	12	45	102	750-260	750-760	750-260-1	750-760-1
11.6	40	55	12	45	102	750-264	750-764	750-264-1	750-764-1
11.7	40	55	12	45	102	750-266	750-766	750-266-1	750-766-1
11.8	40	55	12	45	102	750-268	750-768	750-268-1	750-768-1
11.9	40	55	12	45	102	750-270	750-770	750-270-1	750-770-1
11.91	40	55	12	45	102	750-274	750-774	750-274-1	750-774-1
12	40	55	12	45	102	750-276	750-776	750-276-1	750-776-1
12.5	43	60	14	45	107	750-280	750-780	750-280-1	750-780-1
12.6	43	60	14	45	107	750-282	750-782	750-282-1	750-782-1
12.7	43	60	14	45	107	750-284	750-784	750-284-1	750-784-1
13	43	60	14	45	107	750-286	750-786	750-286-1	750-786-1
13.5	43	60	14	45	107	750-288	750-788	750-288-1	750-788-1
13.7	43	60	14	45	107	750-290	750-790	750-290-1	750-790-1
14	43	60	14	45	107	750-292	750-792	750-292-1	750-792-1
14.29	45	65	16	48	115	750-294	750-794	750-294-1	750-794-1
14.5	45	65	16	48	115	750-296	750-796	750-296-1	750-796-1
14.7	45	65	16	48	115	750-298	750-798	750-298-1	750-798-1
15	45	65	16	48	115	750-300	750-800	750-300-1	750-800-1
15.5	45	65	16	48	115	750-302	750-802	750-302-1	750-802-1
15.7	45	65	16	48	115	750-304	750-804	750-304-1	750-804-1
16	45	65	16	48	115	750-306	750-806	750-306-1	750-806-1
16.5	51	73	18	48	123	750-308	750-808	750-308-1	750-808-1
17	51	73	18	48	123	750-310	750-810	750-310-1	750-810-1
17.5	51	73	18	48	123	750-312	750-812	750-312-1	750-812-1
18	51	73	18	48	123	750-314	750-814	750-314-1	750-814-1
18.5	55	79	20	50	131	750-316	750-816	750-316-1	750-816-1
19	55	79	20	50	131	750-318	750-818	750-318-1	750-818-1
19.5	55	79	20	50	131	750-320	750-820	750-320-1	750-820-1
20	55	79	20	50	131	750-322	750-822	750-322-1	750-822-1

HIGH PERFORMANCE DRILLS



5x倍径实心和中通冷却钻头

5xD	Coated and Uncoated	2 FL, 140° Point and 30° Helix
5倍径	涂层和无涂层	2刃 140°角和30°螺旋

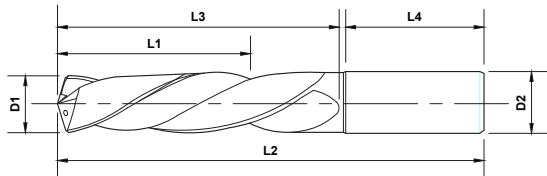

*Hurricane Drills
*飓风硬质合金钻头



Uncoated
Coolant
Through



PowerA
Coolant
Through



OD	LOC	LOF	SHK	SHK-L	OAL	Uncoated		PowerA	
						Non-Coolant Through	Coolant Through	Non-Coolant Through	Coolant Through
D1	L1	L3	D2	L4	L2				
3	23	28	6	36	66	751-002	-	751-002-1	-
3.1	23	28	6	36	66	751-004	-	751-004-1	-
3.17	23	28	6	36	66	751-006	-	751-006-1	-
3.2	23	28	6	36	66	751-010	-	751-010-1	-
3.25	23	28	6	36	66	751-012	-	751-012-1	-
3.3	23	28	6	36	66	751-014	-	751-014-1	-
3.4	23	28	6	36	66	751-016	751-516	751-016-1	751-516-1
3.5	23	28	6	36	66	751-018	751-518	751-018-1	751-518-1
3.57	23	28	6	36	66	751-020	751-520	751-020-1	751-520-1

* For extreme performance drilling, try our PowerNR coating, Use the uncoated part number and add -8.
*如需要超硬钻头,可选择我们的PowerNR涂层,编号为无涂层编号加“-8”

HIGH PERFORMANCE DRILLS

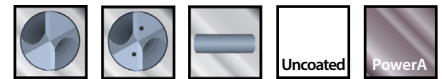

5x倍径实心和中通冷却钻头



OD	LOC	LOF	SHK	SHK-L	OAL	Uncoated		PowerA	
						Non-Coolant Through	Coolant Through	Non-Coolant Through	Coolant Through
D1	L1	L3	D2	L4	L2				
3.6	23	28	6	36	66	751-024	751-524	751-024-1	751-524-1
3.7	23	28	6	36	66	751-026	751-526	751-026-1	751-526-1
3.8	29	36	6	36	74	751-028	751-528	751-028-1	751-528-1
3.9	29	36	6	36	74	751-030	751-530	751-030-1	751-530-1
3.97	29	36	6	36	74	751-034	751-534	751-034-1	751-534-1
4	29	36	6	36	74	751-036	751-536	751-036-1	751-536-1
4.1	29	36	6	36	74	751-038	751-538	751-038-1	751-538-1
4.2	29	36	6	36	74	751-040	751-540	751-040-1	751-540-1
4.3	29	36	6	36	74	751-042	751-542	751-042-1	751-542-1
4.37	29	36	6	36	74	751-046	751-546	751-046-1	751-546-1
4.4	29	36	6	36	74	751-048	751-548	751-048-1	751-548-1
4.5	29	36	6	36	74	751-050	751-550	751-050-1	751-550-1
4.6	29	36	6	36	74	751-052	751-552	751-052-1	751-552-1
4.65	29	36	6	36	74	751-054	751-554	751-054-1	751-554-1
4.7	35	44	6	36	82	751-056	751-556	751-056-1	751-556-1
4.76	35	44	6	36	82	751-058	751-558	751-058-1	751-558-1
4.8	35	44	6	36	82	751-062	751-562	751-062-1	751-562-1
4.9	35	44	6	36	82	751-064	751-564	751-064-1	751-564-1
5	35	44	6	36	82	751-066	751-566	751-066-1	751-566-1
5.1	35	44	6	36	82	751-068	751-568	751-068-1	751-568-1
5.16	35	44	6	36	82	751-072	751-572	751-072-1	751-572-1
5.2	35	44	6	36	82	751-074	751-574	751-074-1	751-574-1
5.3	35	44	6	36	82	751-076	751-576	751-076-1	751-576-1
5.4	35	44	6	36	82	751-078	751-578	751-078-1	751-578-1
5.5	35	44	6	36	82	751-080	751-580	751-080-1	751-580-1
5.55	35	44	6	36	82	751-082	751-582	751-082-1	751-582-1
5.56	35	44	6	36	82	751-086	751-586	751-086-1	751-586-1
5.6	35	44	6	36	82	751-088	751-588	751-088-1	751-588-1
5.7	35	44	6	36	82	751-090	751-590	751-090-1	751-590-1
5.8	35	44	6	36	82	751-092	751-592	751-092-1	751-592-1
5.9	35	44	6	36	82	751-094	751-594	751-094-1	751-594-1
5.95	35	44	6	36	82	751-096	751-596	751-096-1	751-596-1
6	35	44	6	36	82	751-100	751-600	751-100-1	751-600-1

HIGH PERFORMANCE DRILLS



5x倍径实心和中通冷却钻头



OD	LOC	LOF	SHK	SHK-L	OAL	Uncoated		PowerA	
						Non-Coolant Through	Coolant Through	Non-Coolant Through	Coolant Through
D1	L1	L3	D2	L4	L2				
6.1	43	53	8	36	91	751-102	751-602	751-102-1	751-602-1
6.2	43	53	8	36	91	751-104	751-604	751-104-1	751-604-1
6.3	43	53	8	36	91	751-106	751-606	751-106-1	751-606-1
6.35	43	53	8	36	91	751-108	751-608	751-108-1	751-608-1
6.4	43	53	8	36	91	751-110	751-610	751-110-1	751-610-1
6.5	43	53	8	36	91	751-112	751-612	751-112-1	751-612-1
6.6	43	53	8	36	91	751-114	751-614	751-114-1	751-614-1
6.7	43	53	8	36	91	751-116	751-616	751-116-1	751-616-1
6.75	43	53	8	36	91	751-120	751-620	751-120-1	751-620-1
6.8	43	53	8	36	91	751-122	751-622	751-122-1	751-622-1
6.9	43	53	8	36	91	751-124	751-624	751-124-1	751-624-1
7	43	53	8	36	91	751-126	751-626	751-126-1	751-626-1
7.1	43	53	8	36	91	751-128	751-628	751-128-1	751-628-1
7.14	43	53	8	36	91	751-130	751-630	751-130-1	751-630-1
7.2	43	53	8	36	91	751-134	751-634	751-134-1	751-634-1
7.3	43	53	8	36	91	751-136	751-636	751-136-1	751-636-1
7.4	43	53	8	36	91	751-138	751-638	751-138-1	751-638-1
7.5	43	53	8	36	91	751-140	751-640	751-140-1	751-640-1
7.54	43	53	8	36	91	751-142	751-642	751-142-1	751-642-1
7.6	43	53	8	36	91	751-146	751-646	751-146-1	751-646-1
7.7	43	53	8	36	91	751-148	751-648	751-148-1	751-648-1
7.8	43	53	8	36	91	751-150	751-650	751-150-1	751-650-1
7.9	43	53	8	36	91	751-152	751-652	751-152-1	751-652-1
7.94	43	53	8	36	91	751-156	751-656	751-156-1	751-656-1
8	43	53	8	36	91	751-158	751-658	751-158-1	751-658-1
8.1	49	61	10	40	103	751-160	751-660	751-160-1	751-660-1
8.2	49	61	10	40	103	751-162	751-662	751-162-1	751-662-1
8.3	49	61	10	40	103	751-164	751-664	751-164-1	751-664-1
8.33	49	61	10	40	103	751-166	751-666	751-166-1	751-666-1
8.4	49	61	10	40	103	751-170	751-670	751-170-1	751-670-1
8.5	49	61	10	40	103	751-172	751-672	751-172-1	751-672-1
8.6	49	61	10	40	103	751-174	751-674	751-174-1	751-674-1
8.7	49	61	10	40	103	751-176	751-676	751-176-1	751-676-1

HIGH PERFORMANCE DRILLS



HIGH PERFORMANCE DRILLS

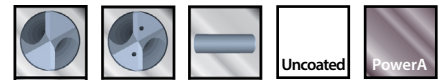

5x倍径实心和中通冷却钻头



OD	LOC	LOF	SHK	SHK-L	OAL	Uncoated		PowerA	
						Non-Coolant Through	Coolant Through	Non-Coolant Through	Coolant Through
D1	L1	L3	D2	L4	L2				
8.73	49	61	10	40	103	751-178	751-678	751-178-1	751-678-1
8.8	49	61	10	40	103	751-182	751-682	751-182-1	751-682-1
8.9	49	61	10	40	103	751-184	751-684	751-184-1	751-684-1
9	49	61	10	40	103	751-186	751-686	751-186-1	751-686-1
9.1	49	61	10	40	103	751-188	751-688	751-188-1	751-688-1
9.13	49	61	10	40	103	751-192	751-692	751-192-1	751-692-1
9.2	49	61	10	40	103	751-194	751-694	751-194-1	751-694-1
9.25	49	61	10	40	103	751-196	751-696	751-196-1	751-696-1
9.3	49	61	10	40	103	751-198	751-698	751-198-1	751-698-1
9.4	49	61	10	40	103	751-200	751-700	751-200-1	751-700-1
9.5	49	61	10	40	103	751-202	751-702	751-202-1	751-702-1
9.52	49	61	10	40	103	751-204	751-704	751-204-1	751-704-1
9.6	49	61	10	40	103	751-208	751-708	751-208-1	751-708-1
9.7	49	61	10	40	103	751-210	751-710	751-210-1	751-710-1
9.8	49	61	10	40	103	751-212	751-712	751-212-1	751-712-1
9.9	49	61	10	40	103	751-214	751-714	751-214-1	751-714-1
9.92	49	61	10	40	103	751-216	751-716	751-216-1	751-716-1
10	49	61	10	40	103	751-220	751-720	751-220-1	751-720-1
10.1	56	71	12	45	118	751-222	751-722	751-222-1	751-722-1
10.2	56	71	12	45	118	751-224	751-724	751-224-1	751-724-1
10.3	56	71	12	45	118	751-226	751-726	751-226-1	751-726-1
10.32	56	71	12	45	118	751-230	751-730	751-230-1	751-730-1
10.4	56	71	12	45	118	751-232	751-732	751-232-1	751-732-1
10.5	56	71	12	45	118	751-234	751-734	751-234-1	751-734-1
10.6	56	71	12	45	118	751-236	751-736	751-236-1	751-736-1
10.7	56	71	12	45	118	751-238	751-738	751-238-1	751-738-1
10.8	56	71	12	45	118	751-242	751-742	751-242-1	751-742-1
10.9	56	71	12	45	118	751-244	751-744	751-244-1	751-744-1
11	56	71	12	45	118	751-246	751-746	751-246-1	751-746-1
11.1	56	71	12	45	118	751-248	751-748	751-248-1	751-748-1
11.11	56	71	12	45	118	751-250	751-750	751-250-1	751-750-1
11.2	56	71	12	45	118	751-254	751-754	751-254-1	751-754-1
11.3	56	71	12	45	118	751-256	751-756	751-256-1	751-756-1

HIGH PERFORMANCE DRILLS

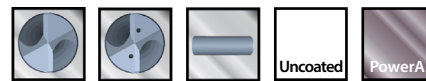

5x倍径实心和中通冷却钻头



OD	LOC	LOF	SHK	SHK-L	OAL	Uncoated		PowerA	
						Non-Coolant Through	Coolant Through	Non-Coolant Through	Coolant Through
D1	L1	L3	D2	L4	L2				
11.4	56	71	12	45	118	751-258	751-758	751-258-1	751-758-1
11.5	56	71	12	45	118	751-260	751-760	751-260-1	751-760-1
11.6	56	71	12	45	118	751-264	751-764	751-264-1	751-764-1
11.7	56	71	12	45	118	751-266	751-766	751-266-1	751-766-1
11.8	56	71	12	45	118	751-268	751-768	751-268-1	751-768-1
11.9	56	71	12	45	118	751-270	751-770	751-270-1	751-770-1
11.91	56	71	12	45	118	751-274	751-774	751-274-1	751-774-1
12	56	71	12	45	118	751-276	751-776	751-276-1	751-776-1
12.5	60	77	14	45	124	751-280	751-780	751-280-1	751-780-1
12.6	60	77	14	45	124	751-282	751-782	751-282-1	751-782-1
12.7	60	77	14	45	124	751-284	751-784	751-284-1	751-784-1
13	60	77	14	45	124	751-286	751-786	751-286-1	751-786-1
13.5	60	77	14	45	124	751-290	751-790	751-290-1	751-790-1
13.7	60	77	14	45	124	751-292	751-792	751-292-1	751-792-1
14	60	77	14	45	124	751-296	751-796	751-296-1	751-796-1
14.29	63	83	16	48	133	751-302	751-802	751-302-1	751-802-1
14.5	63	83	16	48	133	751-304	751-804	751-304-1	751-804-1
14.7	63	83	16	48	133	751-308	751-808	751-308-1	751-808-1
15	63	83	16	48	133	751-310	751-810	751-310-1	751-810-1
15.5	63	83	16	48	133	751-314	751-814	751-314-1	751-814-1
15.7	63	83	16	48	133	751-316	751-816	751-316-1	751-816-1
15.875	63	83	16	48	133	751-318	751-818	751-318-1	751-818-1
16	63	83	16	48	133	751-320	751-820	751-320-1	751-820-1
16.5	71	93	18	48	143	751-322	751-822	751-322-1	751-822-1
17	71	93	18	48	143	751-324	751-824	751-324-1	751-824-1
17.5	71	93	18	48	143	751-326	751-826	751-326-1	751-826-1
18	71	93	18	48	143	751-328	751-828	751-328-1	751-828-1
18.5	77	101	20	50	153	751-330	751-830	751-330-1	751-830-1
19	77	101	20	50	153	751-332	751-832	751-332-1	751-832-1
19.5	77	101	20	50	153	751-334	751-834	751-334-1	751-834-1
20	77	101	20	50	153	751-336	751-836	751-336-1	751-836-1

* For extreme performance drilling, try our PowerNR coating. Use the uncoated part number and add -8.

*如需要超硬钻头,可选择我们的PowerNR涂层,编号为无涂层编号加"-8"

HIGH PERFORMANCE DRILLS



HIGH PERFORMANCE DRILLS

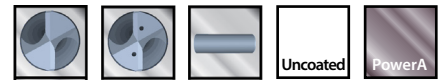

8x倍径实心和中通冷却钻头

8xD	Coated and Uncoated	2 FL, 140° Point and 30° Helix
8倍径	涂层和无涂层	2刃 140°角和30°螺旋

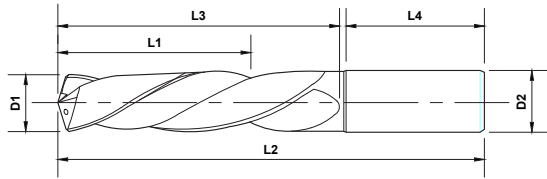

*Hurricane Drills
*飓风硬质合金钻头

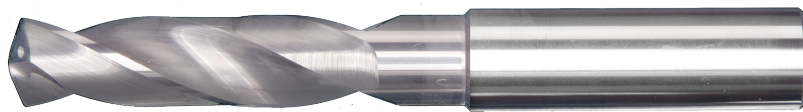

Uncoated
Coolant
Through



PowerA
Coolant
Through

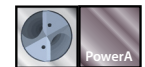

OD	LOC	LOF	SHK	SHK-L	OAL	Uncoated		PowerA	
						Non-Coolant Through	Coolant Through	Non-Coolant Through	Coolant Through
D1	L1	L3	D2	L4	L2				
3.4	29	34	6	34	72	-	752-512	-	752-512-1
3.5	29	34	6	34	72	-	752-514	-	752-514-1
3.6	29	34	6	34	72	-	752-518	-	752-518-1
3.7	29	34	6	34	72	-	752-520	-	752-520-1
3.8	36	43	6	34	81	-	752-522	-	752-522-1
3.9	36	43	6	34	81	-	752-524	-	752-524-1
4	36	43	6	34	81	-	752-528	-	752-528-1

* For extreme performance drilling, try our PowerNR coating. Use the uncoated part number and add -8.

*如需要超硬钻头,可选择我们的PowerNR涂层,编号为无涂层编号加“-8”

HIGH PERFORMANCE DRILLS

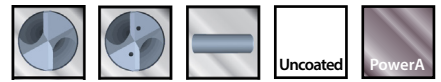

8x倍径实心和中通冷却钻头



HIGH PERFORMANCE DRILLS



OD	LOC	LOF	SHK	SHK-L	OAL	Uncoated		PowerA	
						Non-Coolant Through	Coolant Through	Non-Coolant Through	Coolant Through
D1	L1	L3	D2	L4	L2				
4.1	36	43	6	34	81	-	752-530	-	752-530-1
4.2	36	43	6	34	81	-	752-532	-	752-532-1
4.3	36	43	6	34	81	-	752-534	-	752-534-1
4.4	36	43	6	34	81	-	752-538	-	752-538-1
4.5	36	43	6	34	81	-	752-540	-	752-540-1
4.6	36	43	6	34	81	-	752-542	-	752-542-1
4.7	36	43	6	34	81	-	752-544	-	752-544-1
4.8	53	57	6	34	95	-	752-548	-	752-548-1
4.9	53	57	6	34	95	-	752-550	-	752-550-1
5	53	57	6	36	95	-	752-552	-	752-552-1
5.1	53	57	6	36	95	-	752-554	-	752-554-1
5.2	53	57	6	36	95	-	752-558	-	752-558-1
5.3	53	57	6	36	95	-	752-560	-	752-560-1
5.4	53	57	6	36	95	-	752-562	-	752-562-1
5.5	53	57	6	36	95	-	752-564	-	752-564-1
5.6	53	57	6	36	95	-	752-568	-	752-568-1
5.7	53	57	6	36	95	-	752-570	-	752-570-1
5.8	53	57	6	36	95	-	752-572	-	752-572-1
5.9	53	57	6	36	95	-	752-574	-	752-574-1
6	53	57	6	36	95	-	752-578	-	752-578-1
6.1	66	76	8	36	114	-	752-580	-	752-580-1
6.2	66	76	8	36	114	-	752-582	-	752-582-1
6.3	66	76	8	36	114	-	752-584	-	752-584-1
6.35	66	76	8	36	114	-	752-586	-	752-586-1
6.4	66	76	8	36	114	-	752-588	-	752-588-1
6.5	66	76	8	36	114	-	752-590	-	752-590-1
6.6	66	76	8	36	114	-	752-592	-	752-592-1
6.7	66	76	8	36	114	-	752-594	-	752-594-1
6.8	66	76	8	36	114	-	752-598	-	752-598-1
6.9	66	76	8	36	114	-	752-600	-	752-600-1

HIGH PERFORMANCE DRILLS

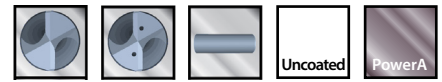

8x倍径实心和中通冷却钻头



OD	LOC	LOF	SHK	SHK-L	OAL	Uncoated		PowerA	
						Non-Coolant Through	Coolant Through	Non-Coolant Through	Coolant Through
7	66	76	8	36	114	-	752-602	-	752-602-1
7.1	66	76	8	36	114	-	752-604	-	752-604-1
7.2	66	76	8	36	114	-	752-608	-	752-608-1
7.3	66	76	8	36	114	-	752-610	-	752-610-1
7.4	66	76	8	36	114	-	752-612	-	752-612-1
7.5	66	76	8	36	114	-	752-614	-	752-614-1
7.6	66	76	8	36	114	-	752-618	-	752-618-1
7.7	66	76	8	36	114	-	752-620	-	752-620-1
7.8	66	76	8	36	114	-	752-622	-	752-622-1
7.9	66	76	8	36	114	-	752-624	-	752-624-1
8	66	76	8	36	114	-	752-628	-	752-628-1
8.1	85	95	10	45	142	-	752-630	-	752-630-1
8.2	85	95	10	45	142	-	752-632	-	752-632-1
8.3	85	95	10	45	142	-	752-634	-	752-634-1
8.4	85	95	10	45	142	-	752-638	-	752-638-1
8.5	85	95	10	45	142	-	752-640	-	752-640-1
8.6	85	95	10	45	142	-	752-642	-	752-642-1
8.7	85	95	10	45	142	-	752-644	-	752-644-1
8.8	85	95	10	45	142	-	752-648	-	752-648-1
8.9	85	95	10	45	142	-	752-650	-	752-650-1
9	85	95	10	45	142	-	752-652	-	752-652-1
9.1	85	95	10	45	142	-	752-654	-	752-654-1
9.2	85	95	10	45	142	-	752-658	-	752-658-1
9.3	85	95	10	45	142	-	752-660	-	752-660-1
9.4	85	95	10	45	142	-	752-662	-	752-662-1
9.5	85	95	10	45	142	-	752-664	-	752-664-1
9.52	85	95	10	45	142	-	752-666	-	752-666-1
9.6	85	95	10	45	142	-	752-670	-	752-670-1
9.7	85	95	10	45	142	-	752-672	-	752-672-1
9.8	85	95	10	45	142	-	752-674	-	752-674-1
9.9	85	95	10	45	142	-	752-676	-	752-676-1
10	85	95	10	45	142	-	752-680	-	752-680-1
10.1	99	114	12	46	162	-	752-682	-	752-682-1
10.2	99	114	12	46	162	-	752-684	-	752-684-1
10.3	99	114	12	46	162	-	752-686	-	752-686-1

HIGH PERFORMANCE DRILLS



8x倍径实心和中通冷却钻头



OD	LOC	LOF	SHK	SHK-L	OAL	Uncoated		PowerA	
						Non-Coolant Through	Coolant Through	Non-Coolant Through	Coolant Through
D1	L1	L3	D2	L4	L2				
10.4	99	114	12	46	162	-	752-690	-	752-690-1
10.5	99	114	12	46	162	-	752-692	-	752-692-1
10.6	99	114	12	46	162	-	752-694	-	752-694-1
10.7	99	114	12	46	162	-	752-696	-	752-696-1
10.8	99	114	12	46	162	-	752-700	-	752-700-1
10.9	99	114	12	46	162	-	752-702	-	752-702-1
11	99	114	12	46	162	-	752-704	-	752-704-1
11.1	99	114	12	46	162	-	752-706	-	752-706-1
11.2	99	114	12	46	162	-	752-710	-	752-710-1
11.3	99	114	12	46	162	-	752-712	-	752-712-1
11.4	99	114	12	46	162	-	752-714	-	752-714-1
11.5	99	114	12	46	162	-	752-716	-	752-716-1
11.6	99	114	12	46	162	-	752-720	-	752-720-1
11.7	99	114	12	46	162	-	752-722	-	752-722-1
11.8	99	114	12	46	162	-	752-724	-	752-724-1
11.9	99	114	12	46	162	-	752-726	-	752-726-1
12	99	114	12	46	162	-	752-730	-	752-730-1
12.5	116	133	14	47	182	-	752-734	-	752-734-1
12.7	116	133	14	47	182	-	752-736	-	752-736-1
13	116	133	14	47	182	-	752-738	-	752-738-1
13.5	116	133	14	47	182	-	752-740	-	752-740-1
14	116	133	14	47	182	-	752-742	-	752-742-1
14.5	132	152	16	50	204	-	752-744	-	752-744-1
15	132	152	16	50	204	-	752-746	-	752-746-1
15.5	132	152	16	50	204	-	752-748	-	752-748-1
16	132	152	16	50	204	-	752-750	-	752-750-1
16.5	150	171	18	50	223	-	752-752	-	752-752-1
17	150	171	18	50	223	-	752-754	-	752-754-1
17.5	150	171	18	50	223	-	752-756	-	752-756-1
18	150	171	18	50	223	-	752-758	-	752-758-1
18.5	166	190	20	52	244	-	752-760	-	752-760-1
19	166	190	20	52	244	-	752-762	-	752-762-1
19.5	166	190	20	52	244	-	752-766	-	752-766-1
20	166	190	20	52	244	-	752-768	-	752-768-1

HIGH PERFORMANCE DRILLS



BURS 旋转文件

- **Full Line of Shapes and Cut Types**
涵盖各种形状和刃型全系列旋转锉产品
- **Special Purpose and Custom Burs Available**
提供特种用途和客户定做旋转锉

Mastercut's patented brazing process gives our burs the extra strength you need to push harder and run faster.

Mastercut的专利钎焊工艺为我们的工具提供了更多动力，让您更加努力，更快地运行。

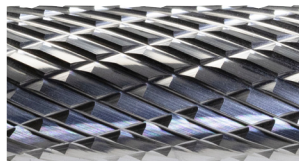

DOUBLECUT (DC)

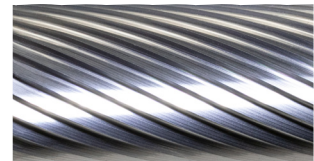

SINGLECUT (SC)

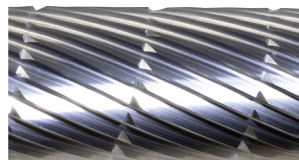

CHIPBREAKER (CB)

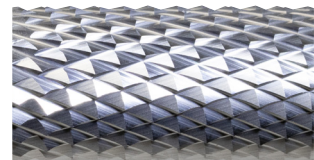

DIAMONDCUT (DM)

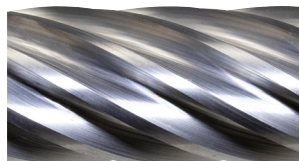

ALUMACUT (FM)
For Aluminum



NX CUT (NX)
For Stainless Steel

LEGENDS - 图示说明

<div style="background-color: #008000; color: white; padding: 5px; text-align: center;"> Non-Ferrous N </div>	Alumacuts recommended for non-ferrous materials
	Alumacuts建议用于 有色金属材料去毛刺













Mastercut's Superior Carbide Blend – A-Gr-SiV (Active Grain Sized Volume)

Our superior tungsten carbide gives you the ability to be *aggressive* when you need to be. Growth inhibitors in our submicron carbide blanks maintain the most consistent grain size available, giving you superior hardness and toughness.

迈斯卡的超级硬质合金材质 - A-Gr-SiV













迈斯卡的超级硬质合金材质 - 拥有均匀亚微米晶粒，完美的硬度和韧性的结合，保证我们的刀具可以面对各种挑战时游刃有余

TABLE OF CONTENTS - 目录

	SA Burs - Cylindrical Shape without End Cut SA-园柱型,无端切旋转锉 139	<div style="display: flex; gap: 5px;"> <div style="background-color: #cccccc; padding: 2px;">Hardened H</div> <div style="background-color: #ff0000; color: white; padding: 2px;">Cast Iron K</div> <div style="background-color: #ff9900; padding: 2px;">Titanium S</div> <div style="background-color: #ffff00; padding: 2px;">Stainless M</div> <div style="background-color: #0000ff; color: white; padding: 2px;">Steel P</div> </div>
	SB Burs - Cylindrical Shape with End Cut SB-园柱型,带端切旋转锉 140	<div style="display: flex; gap: 5px;"> <div style="background-color: #cccccc; padding: 2px;">Hardened H</div> <div style="background-color: #ff0000; color: white; padding: 2px;">Cast Iron K</div> <div style="background-color: #ff9900; padding: 2px;">Titanium S</div> <div style="background-color: #ffff00; padding: 2px;">Stainless M</div> <div style="background-color: #0000ff; color: white; padding: 2px;">Steel P</div> </div>
	SC Burs - Radius Cylindrical Shape SC-球头柱体型旋转锉 141	<div style="display: flex; gap: 5px;"> <div style="background-color: #cccccc; padding: 2px;">Hardened H</div> <div style="background-color: #ff0000; color: white; padding: 2px;">Cast Iron K</div> <div style="background-color: #ff9900; padding: 2px;">Titanium S</div> <div style="background-color: #ffff00; padding: 2px;">Stainless M</div> <div style="background-color: #0000ff; color: white; padding: 2px;">Steel P</div> </div>
	SD Burs - Ball Shape SD-球体型旋转锉 142	<div style="display: flex; gap: 5px;"> <div style="background-color: #cccccc; padding: 2px;">Hardened H</div> <div style="background-color: #ff0000; color: white; padding: 2px;">Cast Iron K</div> <div style="background-color: #ff9900; padding: 2px;">Titanium S</div> <div style="background-color: #ffff00; padding: 2px;">Stainless M</div> <div style="background-color: #0000ff; color: white; padding: 2px;">Steel P</div> </div>
	SE Burs - Oval Shape SE-橄榄型旋转锉 143	<div style="display: flex; gap: 5px;"> <div style="background-color: #cccccc; padding: 2px;">Hardened H</div> <div style="background-color: #ff0000; color: white; padding: 2px;">Cast Iron K</div> <div style="background-color: #ff9900; padding: 2px;">Titanium S</div> <div style="background-color: #ffff00; padding: 2px;">Stainless M</div> <div style="background-color: #0000ff; color: white; padding: 2px;">Steel P</div> </div>
	SF Burs - Radius Tree Shape SF-圆顶树体型旋转锉 144	<div style="display: flex; gap: 5px;"> <div style="background-color: #cccccc; padding: 2px;">Hardened H</div> <div style="background-color: #ff0000; color: white; padding: 2px;">Cast Iron K</div> <div style="background-color: #ff9900; padding: 2px;">Titanium S</div> <div style="background-color: #ffff00; padding: 2px;">Stainless M</div> <div style="background-color: #0000ff; color: white; padding: 2px;">Steel P</div> </div>
	SG Burs - Pointed Tree Shape SG-尖顶树体型旋转锉 145	<div style="display: flex; gap: 5px;"> <div style="background-color: #cccccc; padding: 2px;">Hardened H</div> <div style="background-color: #ff0000; color: white; padding: 2px;">Cast Iron K</div> <div style="background-color: #ff9900; padding: 2px;">Titanium S</div> <div style="background-color: #ffff00; padding: 2px;">Stainless M</div> <div style="background-color: #0000ff; color: white; padding: 2px;">Steel P</div> </div>
	SH Burs - Flame Shape SH-火焰型旋转锉 146	<div style="display: flex; gap: 5px;"> <div style="background-color: #cccccc; padding: 2px;">Hardened H</div> <div style="background-color: #ff0000; color: white; padding: 2px;">Cast Iron K</div> <div style="background-color: #ff9900; padding: 2px;">Titanium S</div> <div style="background-color: #ffff00; padding: 2px;">Stainless M</div> <div style="background-color: #0000ff; color: white; padding: 2px;">Steel P</div> </div>
	SJ Burs - 60° Included Cone Shape SJ-60°锥体型旋转锉 147	<div style="display: flex; gap: 5px;"> <div style="background-color: #cccccc; padding: 2px;">Hardened H</div> <div style="background-color: #ff0000; color: white; padding: 2px;">Cast Iron K</div> <div style="background-color: #ff9900; padding: 2px;">Titanium S</div> <div style="background-color: #ffff00; padding: 2px;">Stainless M</div> <div style="background-color: #0000ff; color: white; padding: 2px;">Steel P</div> </div>
	SK Burs - 90° Included Cone Shape SK-90°锥体型旋转锉 147	<div style="display: flex; gap: 5px;"> <div style="background-color: #cccccc; padding: 2px;">Hardened H</div> <div style="background-color: #ff0000; color: white; padding: 2px;">Cast Iron K</div> <div style="background-color: #ff9900; padding: 2px;">Titanium S</div> <div style="background-color: #ffff00; padding: 2px;">Stainless M</div> <div style="background-color: #0000ff; color: white; padding: 2px;">Steel P</div> </div>
	SL Burs - Radius Cone Shape SL-圆顶锥体型旋转锉 148	<div style="display: flex; gap: 5px;"> <div style="background-color: #cccccc; padding: 2px;">Hardened H</div> <div style="background-color: #ff0000; color: white; padding: 2px;">Cast Iron K</div> <div style="background-color: #ff9900; padding: 2px;">Titanium S</div> <div style="background-color: #ffff00; padding: 2px;">Stainless M</div> <div style="background-color: #0000ff; color: white; padding: 2px;">Steel P</div> </div>
	SM Burs - Pointed Cone Shape SM-尖顶锥体型旋转锉 149	<div style="display: flex; gap: 5px;"> <div style="background-color: #cccccc; padding: 2px;">Hardened H</div> <div style="background-color: #ff0000; color: white; padding: 2px;">Cast Iron K</div> <div style="background-color: #ff9900; padding: 2px;">Titanium S</div> <div style="background-color: #ffff00; padding: 2px;">Stainless M</div> <div style="background-color: #0000ff; color: white; padding: 2px;">Steel P</div> </div>
	SN Burs - Inverted Cone Shape SN-倒锥体型旋转锉 150	<div style="display: flex; gap: 5px;"> <div style="background-color: #cccccc; padding: 2px;">Hardened H</div> <div style="background-color: #ff0000; color: white; padding: 2px;">Cast Iron K</div> <div style="background-color: #ff9900; padding: 2px;">Titanium S</div> <div style="background-color: #ffff00; padding: 2px;">Stainless M</div> <div style="background-color: #0000ff; color: white; padding: 2px;">Steel P</div> </div>

BURS

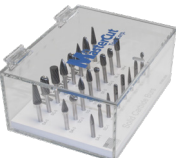
TABLE OF CONTENTS - 目录

	Fiberglass Routers 玻璃纤维专用锉铣刀151	N/A
	Diemills Diemills.152	
	Piloted Diemills Piloted Diemills153	
	Tire Burs 轮胎修理旋转文件154	N/A
	Plastic Pouch Bur Sets 塑料袋装旋转锉组件154	
	12 Piece Plastic Box Bur Sets 塑料盒装旋转锉组件. 155	
	24 Piece Countertop Displays 24件套装展示盒155	

General Bur Speed Recommendations

The following chart is a general and approximate recommendation. Variations to achieve desired results may be necessary. Long shank burs should be used at reduced speeds.

Bur Diameter	RPM
1/8" or 3mm Solid Carbide	45,000-50,000
3/16" or 5mm Solid Carbide	35,000-40,000
3/16" or 5mm Carbide Head Brazed to 1/8" or 3mm Steel Shank	30,000-35,000
1/4" or 6mm Solid Carbide	30,000-35,000
1/4" or 6mm Carbide Head Brazed to 1/8" or 3mm Steel Shank	25,000-30,000
5/16" or 8mm Carbide Head Brazed to 1/4" or 6mm Steel Shank	25,000-30,000
3/8" or 10mm Carbide Head Brazed to 1/4" or 6mm Steel Shank	25,000-30,000
7/16" or 11mm Carbide Head Brazed to 1/4" or 6mm Steel Shank	20,000-25,000
1/2" or 12mm Carbide Head Brazed to 1/4" or 6mm Steel Shank	20,000-25,000
5/8" or 16mm Carbide Head Brazed to 1/4" or 6mm Steel Shank	15,000-20,000
3/4" or 18mm Carbide Head Brazed to 1/4" or 6mm Steel Shank	15,000-20,000
1" or 25mm Carbide Head on 1/4" or 6mm Steel Shank	12,000-18,000

SA BURS - CYLINDRICAL SHAPE WITHOUT ENDCUT

SA-园柱型,无端切旋转锉

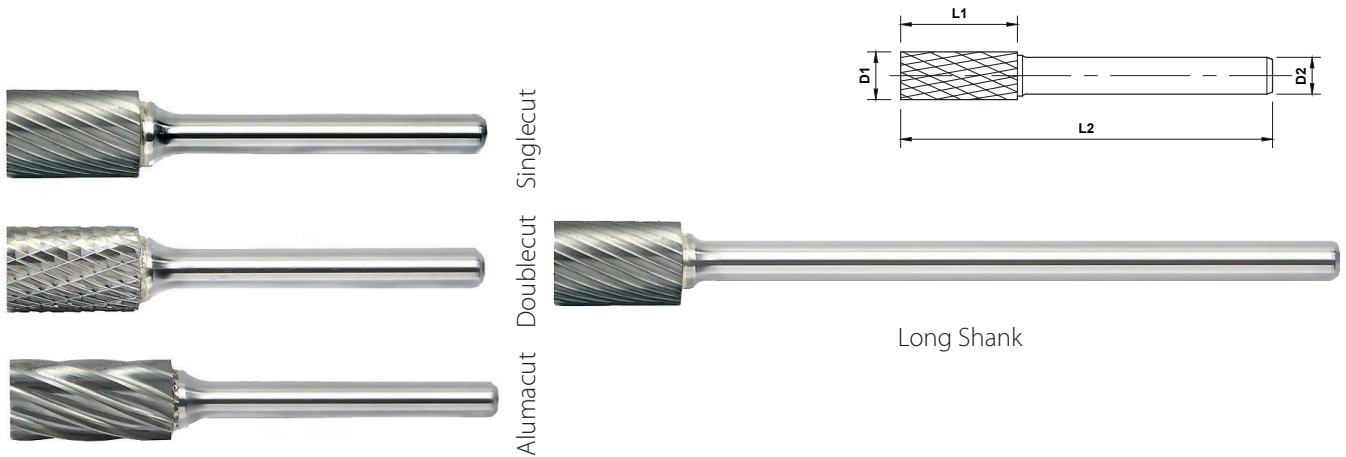

Length Key (K)

Standard Long * Solid Carbide

Quick Ship Items

Non-Ferrous **N** Alumacuts recommended for non-ferrous materials

Cast Iron **K** Titanium **S** Stainless **M** Steel **P** Hardened **H**

K	OD	LOC	SHK	OAL	Cut Type									
					D1	L1	D2	L2	Singlecut	Doublecut	Alumacut	Diamondcut	Chipbreaker	NX Cut
*	1.5	6	3	38					SA-41MMSC	SA-41MMDC	SA-41MMFM	SA-41MMDM	SA-41MMCB	-
*	2.5	11	3	38					SA-42MMSC	SA-42MMDC	SA-42MMFM	SA-42MMDM	SA-42MMCB	-
*	3	12.7	6	50					SA-12MMSC	SA-12MMDC	SA-12MMFM	SA-12MMDM	SA-12MMCB	-
*		14	3	38					SA-43MMSC	SA-43MMDC	SA-43MMFM	SA-43MMDM	SA-43MMCB	-
*	5	16	6	50					SA-14MMSC	SA-14MMDC	SA-14MMFM	SA-14MMDM	SA-14MMCB	-
*	6	25	6	50					SA-1MMASC	SA-1MMADC	SA-1MMAFM	SA-1MMADM	SA-1MMACB	-
*		16	6	50					SA-1MMSC	SA-1MMDC	SA-1MMFM	SA-1MMDM	SA-1MMCB	-
		16	6	162					SA-1MML6SC	SA-1MML6DC	SA-1MML6FM	SA-1MML6DM	SA-1MML6CB	-
	6.3	12.7	3	50					SA-51MMSC	SA-51MMDC	SA-51MMFM	SA-51MMDM	SA-51MMCB	-
	8	25	6	70					SA-2MMASC	SA-2MMADC	SA-2MMAFM	SA-2MMADM	SA-2MMACB	-
		19	6	64					SA-2MMSC	SA-2MMDC	SA-2MMFM	SA-2MMDM	SA-2MMCB	-
	9.5	25	6	70					SA-3MMASC	SA-3MMADC	SA-3MMAFM	SA-3MMADM	SA-3MMACB	-
		38	6	83					SA-3MMBSC	SA-3MMBDC	SA-3MMBFM	SA-3MMBDM	SA-3MMBCB	-
		19	6	64					SA-3MMSC	SA-3MMDC	SA-3MMFM	SA-3MMDM	SA-3MMCB	SA-3MMNX
		19	6	169					SA-3MML6SC	SA-3MML6DC	SA-3MML6FM	SA-3MML6DM	SA-3MML6CB	-
	11	25	6	70					SA-4MMSC	SA-4MMDC	SA-4MMFM	SA-4MMDM	SA-4MMCB	-
		25	6	70					SA-5MMSC	SA-5MMDC	SA-5MMFM	SA-5MMDM	SA-5MMCB	SA-5MMNX
	12.7	25	6	178					SA-5MML6SC	SA-5MML6DC	SA-5MML6FM	SA-5MML6DM	SA-5MML6CB	-
		25	6	70					SA-6MMSC	SA-6MMDC	SA-6MMFM	SA-6MMDM	SA-6MMCB	-
	16	25	6	70					SA-7MMSC	SA-7MMDC	SA-7MMFM	SA-7MMDM	SA-7MMCB	-
	19	25	6	70					SA-9MMSC	SA-9MMDC	SA-9MMFM	SA-9MMDM	SA-9MMCB	-
	25.4	25	6	70					SA-9MMSC	SA-9MMDC	SA-9MMFM	SA-9MMDM	SA-9MMCB	-

* Solid Carbide • *全然 碳化物

SB BURS - CYLINDRICAL SHAPE WITH ENDCUT

SB-园柱型,带端切旋转锉

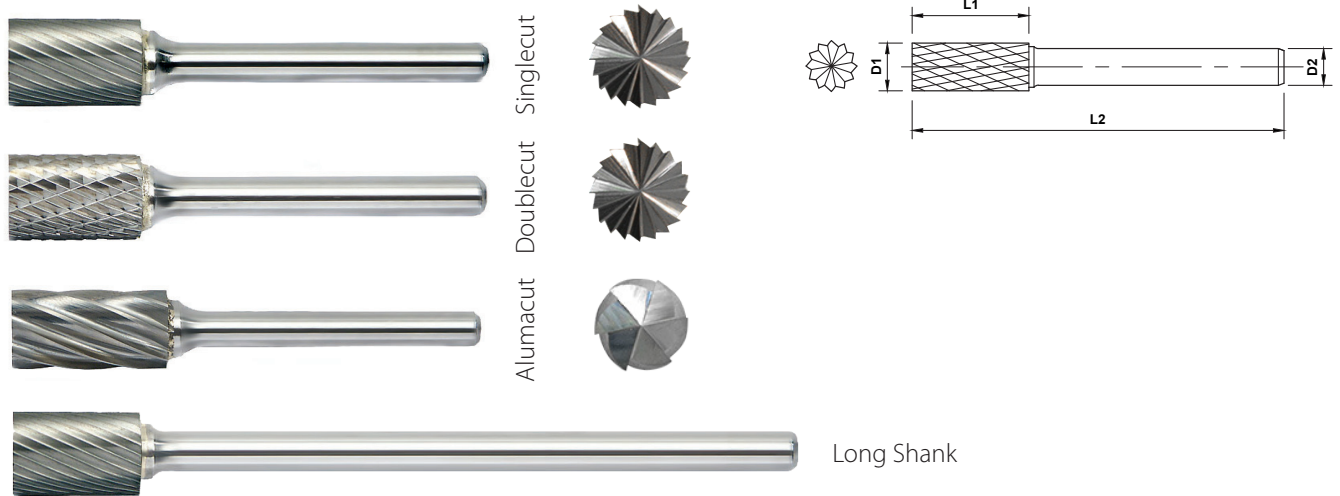

Length Key (K)

Standard Long * Solid Carbide

Quick Ship Items

Non-Ferrous **N** Alumacuts recommended for non-ferrous materials

Cast Iron **K** Titanium **S** Stainless **M** Steel **P** Hardened **H**

	OD	LOC	SHK	OAL	Cut Type				
	D1	L1	D2	L2	Singlecut	Doublecut	Alumacut	Diamondcut	Chipbreaker
*	1.5	6	3	38	SB-41MMSC	SB-41MMDC	SB-41MMFM	SB-41MMDM	SB-41MMCB
*	2.5	11	3	38	SB-42MMSC	SB-42MMDC	SB-42MMFM	SB-42MMDM	SB-42MMCB
*	3	12.7	6	50	SB-11MMSC	SB-11MMDC	SB-11MMFM	SB-11MMDM	SB-11MMCB
*		12.7	6	50	SB-12MMSC	SB-12MMDC	SB-12MMFM	SB-12MMDM	SB-12MMCB
*	5	14	3	38	SB-43MMSC	SB-43MMDC	SB-43MMFM	SB-43MMDM	SB-43MMCB
*		16	6	50	SB-14MMSC	SB-14MMDC	SB-14MMFM	SB-14MMDM	SB-14MMCB
*	6	25	6	50	SB-1MMASC	SB-1MMADC	SB-1MMAFM	SB-1MMADM	SB-1MMACB
*		16	6	50	SB-1MMSC	SB-1MMDC	SB-1MMFM	SB-1MMDM	SB-1MMCB
	6.3	16	6	162	SB-1MML6SC	SB-1MML6DC	SB-1MML6FM	SB-1MML6DM	SB-1MML6CB
		4.7	3	43	SB-51MMSC	SB-51MMDC	SB-51MMFM	SB-51MMDM	SB-51MMCB
	8	25	6	70	SB-2MMASC	SB-2MMADC	SB-2MMAFM	SB-2MMADM	SB-2MMACB
		19	6	64	SB-2MMSC	SB-2MMDC	SB-2MMFM	SB-2MMDM	SB-2MMCB
	9.5	38	6	83	SB-3BMMSC	SB-3BMMDC	SB-3BMMFM	SB-3BMMDM	SB-3BMMCB
		25	6	70	SB-3MMASC	SB-3MMADC	SB-3MMAFM	SB-3MMADM	SB-3MMACB
		19	6	64	SB-3MMSC	SB-3MMDC	SB-3MMFM	SB-3MMDM	SB-3MMCB
		19	6	169	SB-3MML6SC	SB-3MML6DC	SB-3MML6FM	SB-3MML6DM	SB-3MML6CB
	11	25	6	70	SB-4MMSC	SB-4MMDC	SB-4MMFM	SB-4MMDM	SB-4MMCB
	12.7	25	6	70	SB-5MMSC	SB-5MMDC	SB-5MMFM	SB-5MMDM	SB-5MMCB
		25	6	175	SB-5MML6SC	SB-5MML6DC	SB-5MML6FM	SB-5MML6DM	SB-5MML6CB
	16	25	6	70	SB-6MMSC	SB-6MMDC	SB-6MMFM	SB-6MMDM	SB-6MMCB
	19	25	6	70	SB-7MMSC	SB-7MMDC	SB-7MMFM	SB-7MMDM	SB-7MMCB
	25.4	25	6	70	SB-9MMSC	SB-9MMDC	SB-9MMFM	SB-9MMDM	SB-9MMCB

* Solid Carbide • 全 然 碳 化 物

SC BURS - RADIUS CYLINDRICAL SHAPE

SC-球头柱体型旋转锉

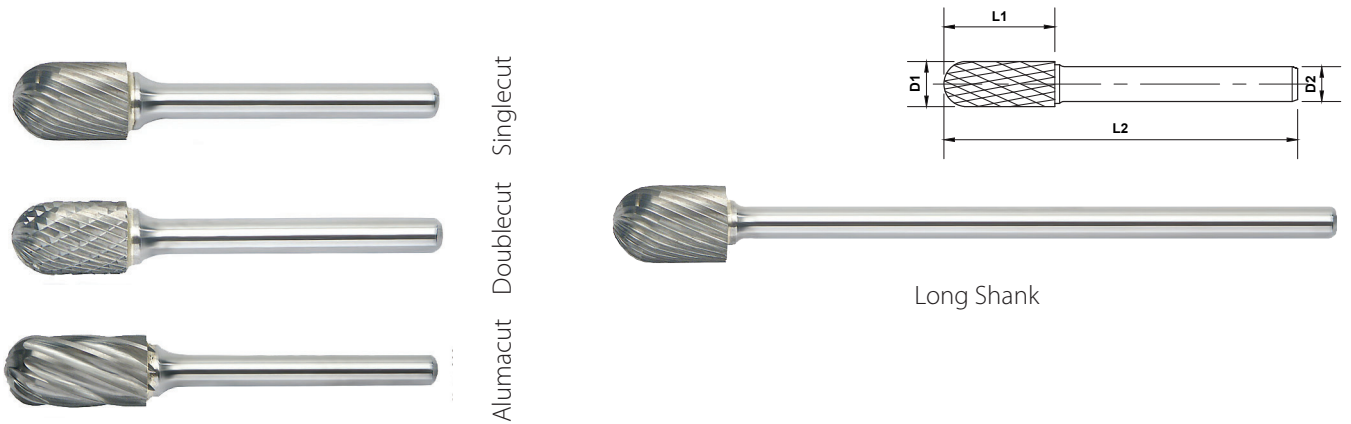

Length Key (K)

Standard Long * Solid Carbide

Quick Ship Items

Non-Ferrous **N** Alumacuts recommended for non-ferrous materials

Cast Iron **K** Titanium **S** Stainless **M** Steel **P** Hardened **H**

	OD	LOC	SHK	OAL	Cut Type					
					D1	L1	D2	L2	Singlecut	Doublecut
*	2.5	11	3	38	SC-41MMSC	SC-41MMDC	SC-41MMFM	SC-41MMDM	SC-41MMCB	-
*		16	6	50	SC-11MMSC	SC-11MMDC	SC-11MMFM	SC-11MMDM	SC-11MMCB	-
*		16	6	50	SC-12MMSC	SC-12MMDC	SC-12MMFM	SC-12MMDM	SC-12MMCB	-
*	3	14	3	38	SC-42MMSC	SC-42MMDC	SC-42MMFM	SC-42MMDM	SC-42MMCB	-
*		14	3	50	SC-42MML2SC	SC-42MML2DC	SC-42MML2FM	SC-42MML2DM	SC-42MML2CB	-
*		14	3	75	SC-42MML3SC	SC-42MML3DC	SC-42MML3FM	SC-42MML3DM	SC-42MML3CB	-
*	4	16	6	50	SC-13MMSC	SC-13MMDC	-	SC-13MMDM	-	-
*	5	16	6	50	SC-14MMSC	SC-14MMDC	SC-14MMFM	SC-14MMDM	SC-14MMCB	-
*	6	25	6	50	SC-1MMASC	SC-1MMADC	SC-1MMAFM	SC-1MMADM	SC-1MMACB	-
*		16	6	50	SC-1MMSC	SC-1MMDC	SC-1MMFM	SC-1MMDM	SC-1MMCB	-
*		16	6	162	SC-1MML6SC	SC-1MML6DC	SC-1MML6FM	SC-1MML6DM	SC-1MML6CB	-
	6.3	12.7	3	50	SC-51MMSC	SC-51MMDC	SC-51MMFM	SC-51MMDM	SC-51MMCB	-
	8	25	6	70	SC-2MMASC	SC-2MMADC	SC-2MMAFM	SC-2MMADM	SC-2MMACB	-
		19	6	64	SC-2MMSC	SC-2MMDC	SC-2MMFM	SC-2MMDM	SC-2MMCB	-
	9.5	25	6	70	SC-3MMASC	SC-3MMADC	SC-3MMAFM	SC-3MMADM	SC-3MMACB	-
		19	6	64	SC-3MMSC	SC-3MMDC	SC-3MMFM	SC-3MMDM	SC-3MMCB	SC-3MMNX
	19	6	169	SC-3MML6SC	SC-3MML6DC	SC-3MML6FM	SC-3MML6DM	SC-3MML6CB	-	
	11	25	6	70	SC-4MMSC	SC-4MMDC	SC-4MMFM	SC-4MMDM	SC-4MMCB	-
	12.7	25	6	70	SC-5MMSC	SC-5MMDC	SC-5MMFM	SC-5MMDM	SC-5MMCB	SC-5MMNX
25		6	175	SC-5MML6SC	SC-5MML6DC	SC-5MML6FM	SC-5MML6DM	SC-5MML6CB	-	
	16	25	6	70	SC-6MMSC	SC-6MMDC	SC-6MMFM	SC-6MMDM	SC-6MMCB	-
	19	25	6	70	SC-7MMSC	SC-7MMDC	SC-7MMFM	SC-7MMDM	SC-7MMCB	-
	25.4	25	6	70	SC-9MMSC	SC-9MMDC	SC-9MMFM	SC-9MMDM	SC-9MMCB	-

* Solid Carbide • *全 然 碳化物

SD BURS - BALL SHAPE

SD-球体型旋转锉



Singlecut
Doublecut
Alumacut

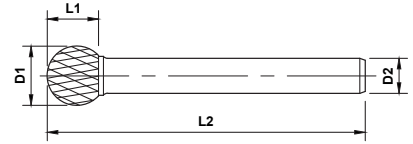

Long Shank

Length Key (K)

Standard Long * Solid Carbide

Quick Ship Items

Non-Ferrous **N** Alumacuts recommended for non-ferrous materials

Cast Iron **K** Titanium **S** Stainless **M** Steel **P** Hardened **H**

	Length Key (K)				Cut Type					
	OD	LOC	SHK	OAL	Singlecut	Doublecut	Alumacut	Diamondcut	Chipbreaker	NX Cut
*	2.5	2.3	3	38	SD-41MMSC	SD-41MMDC	SD-41MMFM	SD-41MMDM	SD-41MMCB	-
*	3	2	6	50	SD-12MMSC	SD-12MMDC	SD-12MMFM	SD-12MMDM	SD-12MMCB	-
*		2.5	3	38	SD-42MMSC	SD-42MMDC	SD-42MMFM	SD-42MMDM	SD-42MMCB	-
*		2.5	3	50	SD-42MML2SC	SD-42MML2DC	SD-42MML2FM	SD-42MML2DM	SD-42MML2CB	-
*		2.5	3	75	SD-42MML3SC	SD-42MML3DC	SD-42MML3FM	SD-42MML3DM	SD-42MML3CB	-
*	5	4	6	50	SD-14MMSC	SD-14MMDC	SD-14MMFM	SD-14MMDM	SD-14MMCB	-
*	6	5	6	50	SD-1MMSC	SD-1MMDC	SD-1MMFM	SD-1MMDM	SD-1MMCB	-
		5	6	155	SD-1MML6SC	SD-1MML6DC	SD-1MML6FM	SD-1MML6DM	SD-1MML6CB	-
	6.3	5	3	44	SD-51MMSC	SD-51MMDC	SD-51MMFM	SD-51MMDM	SD-51MMCB	-
	8	6.4	6	51.4	SD-2MMSC	SD-2MMDC	SD-2MMFM	SD-2MMDM	SD-2MMCB	-
	9.5	8	6	53	SD-3MMSC	SD-3MMDC	SD-3MMFM	SD-3MMDM	SD-3MMCB	SD-3MMNX
		8	6	158	SD-3MML6SC	SD-3MML6DC	SD-3MML6FM	SD-3MML6DM	SD-3MML6CB	-
	11	9.5	6	54.5	SD-4MMSC	SD-4MMDC	SD-4MMFM	SD-4MMDM	SD-4MMCB	-
	12.7	11	6	56	SD-5MMSC	SD-5MMDC	SD-5MMFM	SD-5MMDM	SD-5MMCB	SD-5MMNX
		11	6	161	SD-5MML6SC	SD-5MML6DC	SD-5MML6FM	SD-5MML6DM	SD-5MML6CB	-
	16	14	6	59	SD-6MMSC	SD-6MMDC	SD-6MMFM	SD-6MMDM	SD-6MMCB	-
	19	17	6	62	SD-7MMSC	SD-7MMDC	SD-7MMFM	SD-7MMDM	SD-7MMCB	-
	25.4	23	6	68	SD-9MMSC	SD-9MMDC	SD-9MMFM	SD-9MMDM	SD-9MMCB	-

* Solid Carbide • 全然 碳化物

SE BURS - OVAL SHAPE

SE-橄榄型旋转锉

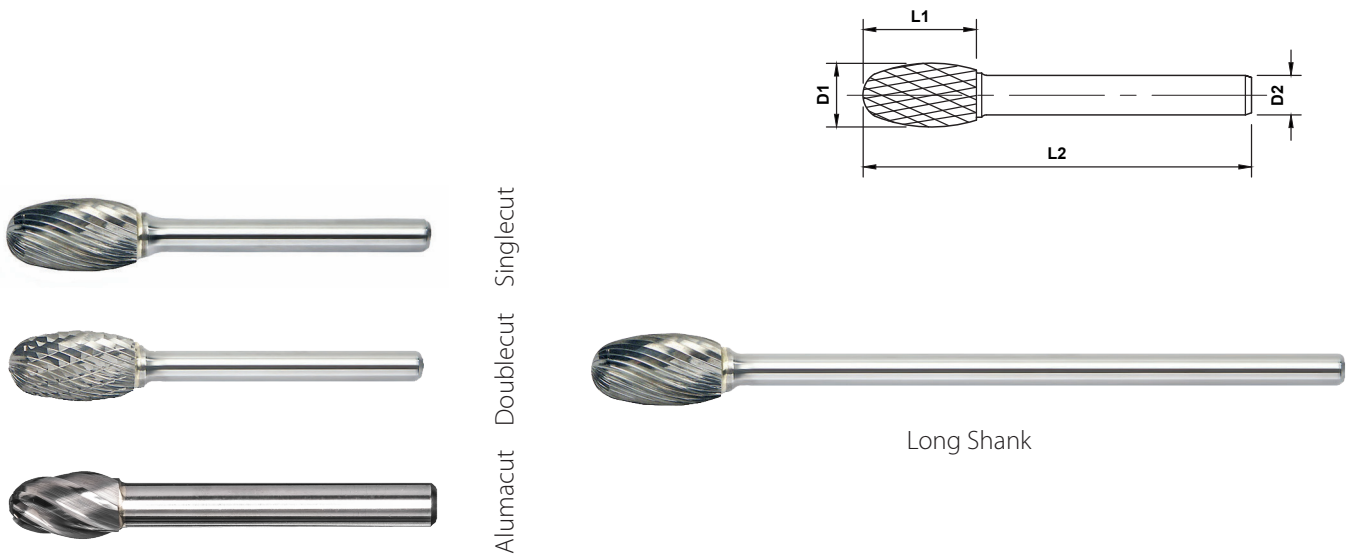

Length Key (K)

Standard Long * Solid Carbide

Quick Ship Items

Non-Ferrous **N** Alumacuts recommended for non-ferrous materials

Cast Iron **K** Titanium **S** Stainless **M** Steel **P** Hardened **H**

	OD	LOC	SHK	OAL	Cut Type					
	D1	L1	D2	L2	Singlecut	Doublecut	Alumacut	Diamondcut	Chipbreaker	NX Cut
*	3	5.5	3	38	SE-41MMSC	SE-41MMDC	SE-41MMFM	SE-41MMDM	SE-41MMCB	-
		5.5	3	50	SE-41MML2SC	SE-41MML2DC	SE-41MML2FM	SE-41MML2DM	SE-41MML2CB	-
		5.5	3	75	SE-41MML3SC	SE-41MML3DC	SE-41MML3FM	SE-41MML3DM	SE-41MML3CB	-
*	6	9.5	6	50	SE-1MMSC	SE-1MMDC	SE-1MMFM	SE-1MMDM	SE-1MMCB	-
		9.5	6	160	SE-1MML6SC	SE-1MML6DC	SE-1MML6FM	SE-1MML6DM	SE-1MML6CB	-
	6.3	9.5	3	47	SE-51MMSC	SE-51MMDC	SE-51MMFM	SE-51MMDM	SE-51MMCB	-
	9.5	16	6	61	SE-3MMSC	SE-3MMDC	SE-3MMFM	SE-3MMDM	SE-3MMCB	SE-3MMNX
		16	6	166	SE-3MML6SC	SE-3MML6DC	SE-3MML6FM	SE-3MML6DM	SE-3MML6CB	-
	12.7	22	6	67	SE-5MMSC	SE-5MMDC	SE-5MMFM	SE-5MMDM	SE-5MMCB	SE-5MMNX
		22	6	172	SE-5MML6SC	SE-5MML6DC	SE-5MML6FM	SE-5MML6DM	SE-5MML6CB	-
	16	25	6	70	SE-6MMSC	SE-6MMDC	SE-6MMFM	SE-6MMDM	SE-6MMCB	-
	19	25	6	70	SE-7MMSC	SE-7MMDC	SE-7MMFM	SE-7MMDM	SE-7MMCB	-

* Solid Carbide • *全然 碳化物

SF BURS - RADIUS TREE SHAPE

SF-圆顶树体型旋转锉



Alumacut Doublecut Singlecut



Long Shank

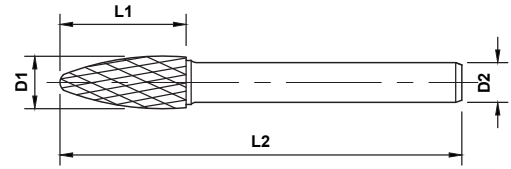

Length Key (K)

Standard Long * Solid Carbide

Quick Ship Items

Non-Ferrous **N** Alumacuts recommended for non-ferrous materials

Cast Iron **K** Titanium **S** Stainless **M** Steel **P** Hardened **H**

	OD	LOC	SHK	OAL	Cut Type					
					D1	L1	D2	L2	Singlecut	Doublecut
*	3	6	3	38	SF-41MMSC	SF-41MMDC	SF-41MMFM	SF-41MMDM	SF-41MMCB	-
		12.7	3	38	SF-42MMSC	SF-42MMDC	SF-42MMFM	SF-42MMDM	SF-42MMCB	-
		12.7	3	50	SF-42MML2SC	SF-42MML2DC	SF-42MML2FM	SF-42MML2DM	SF-42MML2CB	-
		12.7	3	75	SF-42MML3SC	SF-42MML3DC	SF-42MML3FM	SF-42MML3DM	SF-42MML3CB	-
6	16	6	50	SF-1MMSC	SF-1MMDC	SF-1MMFM	SF-1MMDM	SF-1MMCB	-	
	16	6	172	SF-1MML6SC	SF-1MML6DC	SF-1MML6FM	SF-1MML6DM	SF-1MML6CB	-	
6.3	12.7	3	50	SF-51MMSC	SF-51MMDC	SF-51MMFM	SF-51MMDM	SF-51MMCB	-	
9.5	19	6	64	SF-3MMSC	SF-3MMDC	SF-3MMFM	SF-3MMDM	SF-3MMCB	SF-3MMNX	
	19	6	169	SF-3MML6SC	SF-3MML6DC	SF-3MML6FM	SF-3MML6DM	SF-3MML6CB	-	
11	25	6	70	SF-4MMSC	SF-4MMDC	SF-4MMFM	SF-4MMDM	SF-4MMCB	-	
12.7	19	6	64	SF-13MMSC	SF-13MMDC	SF-13MMFM	SF-13MMDM	SF-13MMCB	-	
	25	6	70	SF-5MMSC	SF-5MMDC	SF-5MMFM	SF-5MMDM	SF-5MMCB	SF-5MMNX	
	25	6	175	SF-5MML6SC	SF-5MML6DC	SF-5MML6FM	SF-5MML6DM	SF-5MML6CB	-	
16	25	6	70	SF-6MMSC	SF-6MMDC	SF-6MMFM	SF-6MMDM	SF-6MMCB	-	
19	32	6	77	SF-14MMSC	SF-14MMDC	SF-14MMFM	SF-14MMDM	SF-14MMCB	-	
	38	6	83	SF-15MMSC	SF-15MMDC	SF-15MMFM	SF-15MMDM	SF-15MMCB	-	
	25	6	70	SF-7MMSC	SF-7MMDC	SF-7MMFM	SF-7MMDM	SF-7MMCB	-	

* Solid Carbide * 全然 碳化物

SG BURS - POINTED TREE SHAPE

SG-尖顶树体型旋转锉

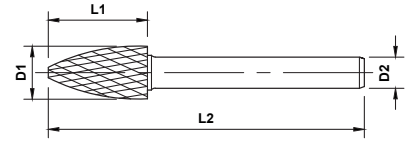

Length Key (K)

Standard Long * Solid Carbide

Quick Ship Items

Non-Ferrous **N** Alumacuts recommended for non-ferrous materials

Cast Iron **K** Titanium **S** Stainless **M** Steel **P** Hardened **H**

	OD	LOC	SHK	OAL	Cut Type					
					D1	L1	D2	L2	Singlecut	Doublecut
*	3	6	3	38	SG-41MMSC	SG-41MMDC	SG-41MMFM	SG-41MMDM	SG-41MMCB	-
		9.5	3	38	SG-43MMSC	SG-43MMDC	SG-43MMFM	SG-43MMDM	SG-43MMCB	-
		12.7	3	38	SG-44MMSC	SG-44MMDC	SG-44MMFM	SG-44MMDM	SG-44MMCB	-
		12.7	3	50	SG-44MML2SC	SG-44MML2DC	SG-44MML2FM	SG-44MML2DM	SG-44MML2CB	-
		12.7	3	75	SG-44MML3SC	SG-44MML3DC	SG-44MML3FM	SG-44MML3DM	SG-44MML3CB	-
6	16	6	50	SG-1MMSC	SG-1MMDC	SG-1MMFM	SG-1MMDM	SG-1MMCB	-	
	16	6	163	SG-1MML6SC	SG-1MML6DC	SG-1MML6FM	SG-1MML6DM	SG-1MML6CB	-	
6.3	12.7	3	50	SG-51MMSC	SG-51MMDC	SG-51MMFM	SG-51MMDM	SG-51MMCB	-	
	8	19	6	64	SG-2MMSC	SG-2MMDC	SG-2MMFM	SG-2MMDM	SG-2MMCB	-
9.5	19	6	64	SG-3MMSC	SG-3MMDC	SG-3MMFM	SG-3MMDM	SG-3MMCB	SG-3MMNX	
	19	6	169	SG-3MML6SC	SG-3MML6DC	SG-3MML6FM	SG-3MML6DM	SG-3MML6CB	-	
12.7	19	6	64	SG-13MMSC	SG-13MMDC	SG-13MMFM	SG-13MMDM	SG-13MMCB	-	
	25	6	70	SG-5MMSC	SG-5MMDC	SG-5MMFM	SG-5MMDM	SG-5MMCB	SG-5MMNX	
	25	6	175	SG-5MML6SC	SG-5MML6DC	SG-5MML6FM	SG-5MML6DM	SG-5MML6CB	-	
16	25	6	70	SG-6MMSC	SG-6MMDC	SG-6MMFM	SG-6MMDM	SG-6MMCB	-	
	19	25	6	70	SG-7MMSC	SG-7MMDC	SG-7MMFM	SG-7MMDM	SG-7MMCB	-

* Solid Carbide • *全然 碳化物

SH BURS - FLAME SHAPE

SH-火焰型旋转锉

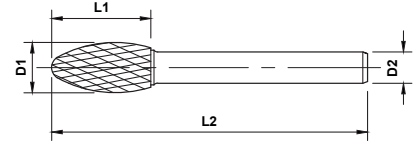

Length Key (K)

Standard Long * Solid Carbide

Quick Ship Items

Non-Ferrous
N Alumacuts recommended for non-ferrous materials

Cast Iron
K

Titanium
S

Stainless
M

Steel
P

Hardened
H

	OD	LOC	SHK	OAL	Cut Type					
					D1	L1	D2	L2	Singlecut	Doublecut
*	3	6.3	3	38	SH-41MMSC	SH-41MMDC	SH-41MMFM	SH-41MMDM	SH-41MMCB	-
		6.3	3	50	SH-41MML2SC	SH-41MML2DC	SH-41MML2FM	SH-41MML2DM	SH-41MML2CB	-
		6.3	3	75	SH-41MML3SC	SH-41MML3DC	SH-41MML3FM	SH-41MML3DM	SH-41MML3CB	-
*	6	12.7	6	50	SH-1MMSC	SH-1MMDC	SH-1MMFM	SH-1MMDM	SH-1MMCB	-
		12.7	6	178	SH-1MML6SC	SH-1MML6DC	SH-1MML6FM	SH-1MML6DM	SH-1MML6CB	-
	8	19	6	64	SH-2MMSC	SH-2MMDC	SH-2MMFM	SH-2MMDM	SH-2MMCB	SH-2MMNX
		19	6	169	SH-2MML6SC	SH-2MML6DC	SH-2MML6FM	SH-2MML6DM	SH-2MML6CB	-
	12.7	32	6	77	SH-5MMSC	SH-5MMDC	SH-5MMFM	SH-5MMDM	SH-5MMCB	SH-5MMNX
		32	6	182	SH-5MML6SC	SH-5MML6DC	SH-5MML6FM	SH-5MML6DM	SH-5MML6CB	-
	16	36	6	81	SH-6MMSC	SH-6MMDC	SH-6MMFM	SH-6MMDM	SH-6MMCB	-
	19	41	6	86	SH-7MMSC	SH-7MMDC	SH-7MMFM	SH-7MMDM	SH-7MMCB	-

* Solid Carbide • 全然 碳化物

SJ BURS - 60° INCLUDED CONE SHAPE

SJ-60°锥体型旋转锉

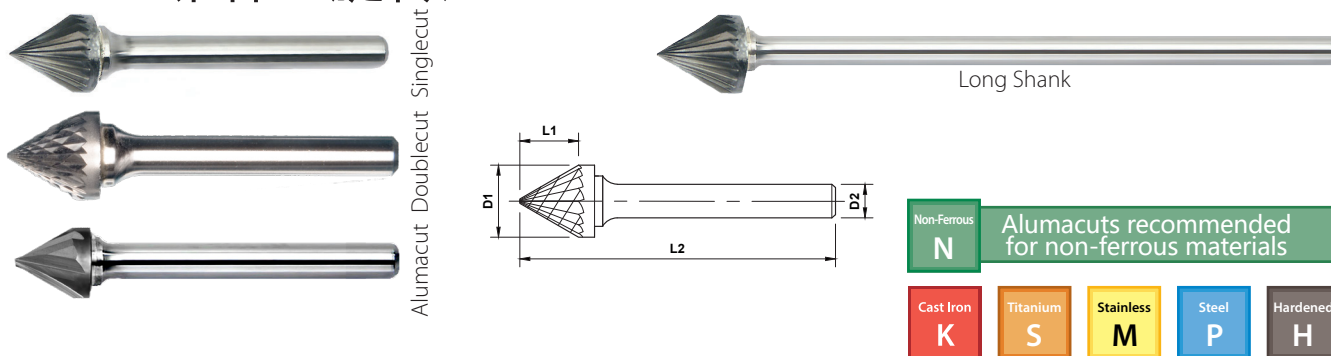

Non-Ferrous **N** Alumacuts recommended for non-ferrous materials

Cast Iron **K** Titanium **S** Stainless **M** Steel **P** Hardened **H**

	OD				Cut Type					
	D1	LOC	SHK	OAL	Singlecut	Doublecut	Alumacut	Diamondcut	Chipbreaker	
*	3	2.5	3	38		SJ-42MMSC	SJ-42MMDC	SJ-42MMFM	SJ-42MMDM	SJ-42MMCB
		2.5	3	38	^	SJ-42MMDESC ^	SJ-42MMDEDC ^	SJ-42MMDEFM ^	SJ-42MMDEDM ^	SJ-42MMDECB ^
*	6	4	6	50		SJ-1MMDESC ^	SJ-1MMDEDC ^	SJ-1MMDEFM ^	SJ-1MMDEDM ^	SJ-1MMDECB ^
		4	6	50		SJ-1MMSC	SJ-1MMDC	SJ-1MMFM	SJ-1MMDM	SJ-1MMCB
	9.5	8	6	53		SJ-3MMSC	SJ-3MMDC	SJ-3MMFM	SJ-3MMDM	SJ-3MMCB
	12.7	11	6	56		SJ-5MMSC	SJ-5MMDC	SJ-5MMFM	SJ-5MMDM	SJ-5MMCB
	16	14.5	6	59.5		SJ-6MMSC	SJ-6MMDC	SJ-6MMFM	SJ-6MMDM	SJ-6MMCB
	19	17.5	6	62.5		SJ-7MMSC	SJ-7MMDC	SJ-7MMFM	SJ-7MMDM	SJ-7MMCB
	25	24.5	6	69.5		SJ-9MMSC	SJ-9MMDC	SJ-9MMFM	SJ-9MMDM	SJ-9MMCB

* Solid Carbide • *全 碳化物 ^ Double End • ^ 双端

SK BURS - 90° INCLUDED CONE SHAPE

SK-90°锥体型旋转锉

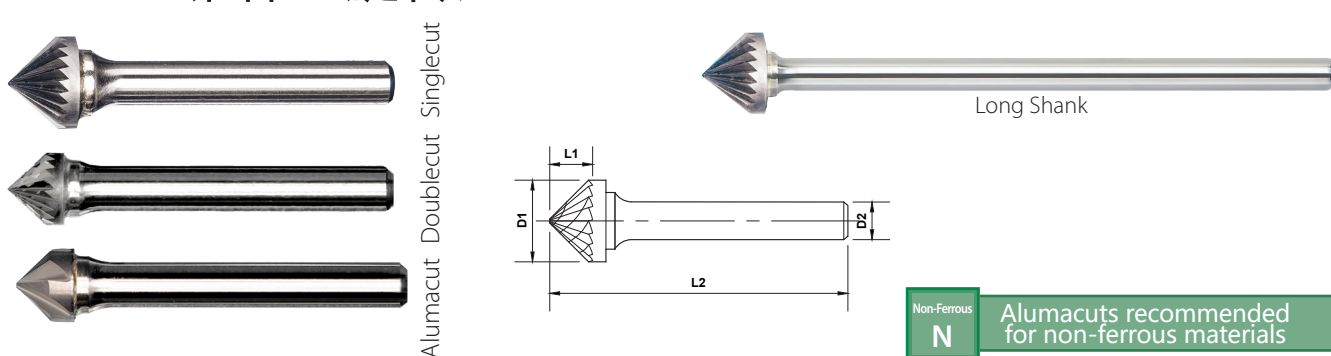

Non-Ferrous **N** Alumacuts recommended for non-ferrous materials

Cast Iron **K** Titanium **S** Stainless **M** Steel **P** Hardened **H**

Length Key (K)

Standard Long * Solid Carbide

	OD				Cut Type					
	D1	LOC	SHK	OAL	Singlecut	Doublecut	Alumacut	Diamondcut	Chipbreaker	
*	3	1.5	3	38		SK-42MMSC	SK-42MMDC	SK-42MMFM	SK-42MMDM	SK-42MMCB
		1.5	3	38	^	SK-42MMSCDE ^	SK-42MMDEDC ^	SK-42MMDEFM ^	SK-42MMDEDM ^	SK-42MMDECB ^
*	6	3	6	50		SK-1MMSC	SK-1MMDC	SK-1MMFM	SK-1MMDM	SK-1MMCB
		3	6	50	^	SK-1MMDESC ^	SK-1MMDEDC ^	SK-1MMDEFM ^	SK-1MMDEDM ^	SK-1MMDECB ^
	9.5	4.7	6	49.7		SK-3MMSC	SK-3MMDC	SK-3MMFM	SK-3MMDM	SK-3MMCB
	12.7	6.3	6	51.3		SK-5MMSC	SK-5MMDC	SK-5MMFM	SK-5MMDM	SK-5MMCB
	16	8	6	53		SK-6MMSC	SK-6MMDC	SK-6MMFM	SK-6MMDM	SK-6MMCB
	19	9.5	6	54.5		SK-7MMSC	SK-7MMDC	SK-7MMFM	SK-7MMDM	SK-7MMCB
	25	12.7	6	57.7		SK-9MMSC	SK-9MMDC	SK-9MMFM	SK-9MMDM	SK-9MMCB

* Solid Carbide • *全 碳化物 ^ Double End • ^ 双端

SL BURS - RADIUS CONE SHAPE

SL-圆顶锥体型旋转锉

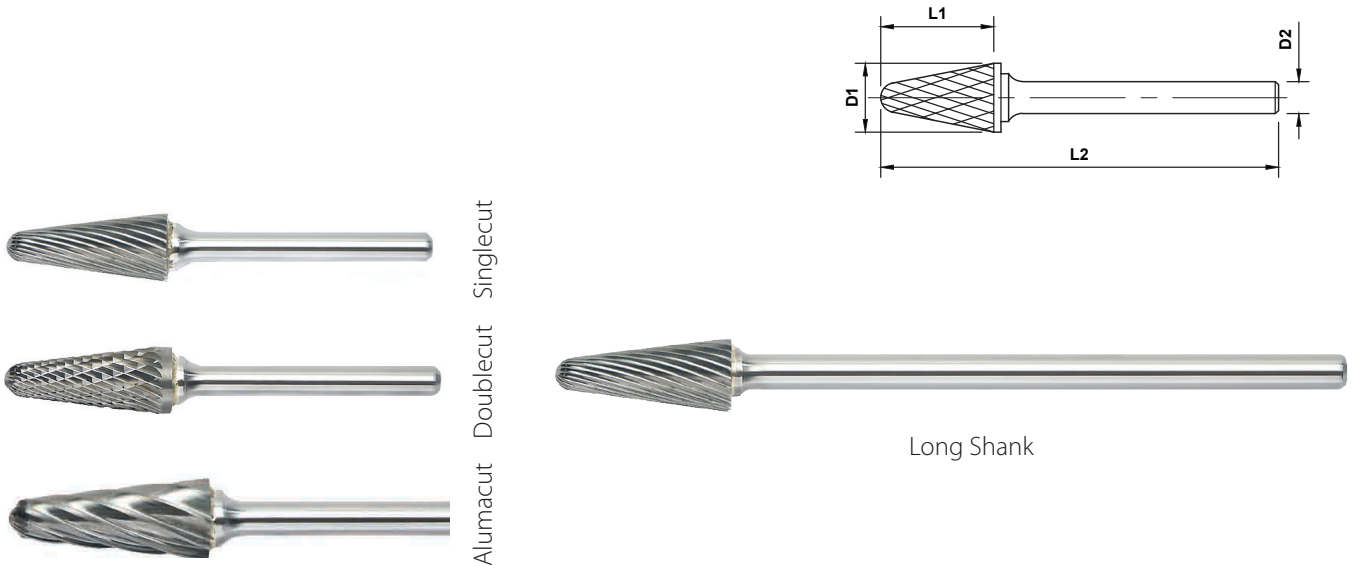

Length Key (K)

Standard Long * Solid Carbide

Quick Ship Items

Non-Ferrous **N** Alumacuts recommended for non-ferrous materials

Cast Iron **K** Titanium **S** Stainless **M** Steel **P** Hardened **H**

	Length Key (K)				Inclusive Angle	Cut Type					
	OD	LOC	SHK	OAL		Singlecut	Doublecut	Alumacut	Diamondcut	Chipbreaker	NX Cut
	D1	L1	D2	L2	DEG °						
* 3	9.5	3	38	8°	SL-41MMSC	SL-41MMDC	SL-41MMFM	SL-41MMDM	SL-41MMCB	-	
	12.7	3	38	8°	SL-42MMSC	SL-42MMDC	SL-42MMFM	SL-42MMDM	SL-42MMCB	-	
* 6	16	6	50	14°	SL-1MMSC	SL-1MMDC	SL-1MMFM	SL-1MMDM	SL-1MMCB	-	
	16	6	166	14°	SL-1MML6SC	SL-1MML6DC	SL-1MML6FM	SL-1MML6DM	SL-1MML6CB	-	
8	22	6	67	14°	SL-2MMSC	SL-2MMDC	SL-2MMFM	SL-2MMDM	SL-2MMCB	-	
9.5	27	6	72	14°	SL-3MMSC	SL-3MMDC	SL-3MMFM	SL-3MMDM	SL-3MMCB	SL-3MMNX	
	27	6	177	14°	SL-3MML6SC	SL-3MML6DC	SL-3MML6FM	SL-3MML6DM	SL-3MML6CB	-	
12.7	28	6	73	14°	SL-4MMSC	SL-4MMDC	SL-4MMFM	SL-4MMDM	SL-4MMCB	SL-4MMNX	
	28	6	178	14°	SL-4MML6SC	SL-4MML6DC	SL-4MML6FM	SL-4MML6DM	SL-4MML6CB	-	
16	30	6	75	14°	SL-5MMSC	SL-5MMDC	SL-5MMFM	SL-5MMDM	SL-5MMCB	-	
	33	6	78	14°	SL-6MMSC	SL-6MMDC	SL-6MMFM	SL-6MMDM	SL-6MMCB	-	
19	38	6	83	14°	SL-7MMSC	SL-7MMDC	SL-7MMFM	SL-7MMDM	SL-7MMCB	-	

* Solid Carbide • *全然 碳化物

SM BURS - POINTED CONE SHAPE

SM-尖顶顶锥体型旋转锉



Singlecut
Doublecut
Alumacut

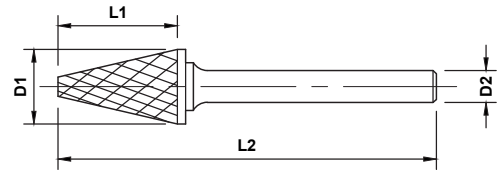

Long Shank

Length Key (K)

Standard Long * Solid Carbide

Quick Ship Items

Alumacuts recommended for non-ferrous materials

Non-Ferrous N
Cast Iron K
Titanium S
Stainless M
Steel P
Hardened H

	Length Key (K)				Inclusive Angle	Cut Type				
	OD	LOC	SHK	OAL		Singlecut	Doublecut	Alumacut	Diamondcut	Chipbreaker
	D1	L1	D2	L2	deg					
*	3	8.9	3	38	12°	SM-41MMSC	SM-41MMDC	SM-41MMFM	SM-41MMDM	SM-41MMCB
*		11	3	38	14°	SM-42MMSC	SM-42MMDC	SM-42MMFM	SM-42MMDM	SM-42MMCB
*		11	3	50	14°	SM-42MML2SC	SM-42MML2DC	SM-42MML2FM	SM-42MML2DM	SM-42MML2CB
*		11	3	75	14°	SM-42MML3SC	SM-42MML3DC	SM-42MML3FM	SM-42MML3DM	SM-42MML3CB
*		16	3	38	7°	SM-43MMSC	SM-43MMDC	SM-43MMFM	SM-43MMDM	SM-43MMCB
*	6	12.7	6	50	12°	SM-1MMSC	SM-1MMDC	SM-1MMFM	SM-1MMDM	SM-1MMCB
*		19	6	50	14°	SM-2MMSC	SM-2MMDC	SM-2MMFM	SM-2MMDM	SM-2MMCB
*		25	6	50	12°	SM-3MMSC	SM-3MMDC	SM-3MMFM	SM-3MMDM	SM-3MMCB
	6.3	12.7	3	54	22°	SM-51MMSC	SM-51MMDC	SM-51MMFM	SM-51MMDM	SM-51MMCB
	9.5	16	6	61	28°	SM-4MMSC	SM-4MMDC	SM-4MMFM	SM-4MMDM	SM-4MMCB
	12.7	22	6	67	28°	SM-5MMSC	SM-5MMDC	SM-5MMFM	SM-5MMDM	SM-5MMCB
	16	25	6	70	31°	SM-6MMSC	SM-6MMDC	SM-6MMFM	SM-6MMDM	SM-6MMCB

* Solid Carbide • *全然 碳化物

SN BURS - INVERTED CONE SHAPE

SN-倒锥体型旋转锉

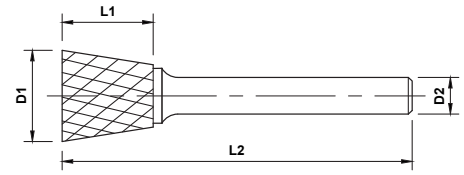
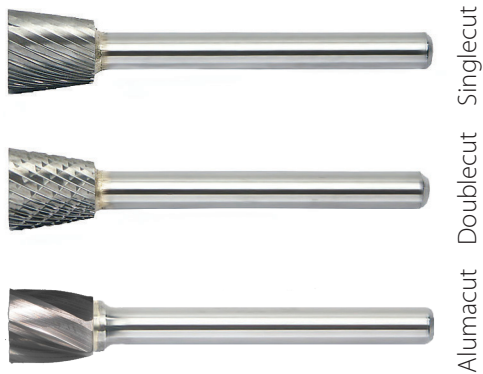

Non-Ferrous **N** Alumacuts recommended for non-ferrous materials

Cast Iron **K** Titanium **S** Stainless **M** Steel **P** Hardened **H**

Length Key (K)

Standard Long * Solid Carbide

	OD	LOC	SHK	OAL	Inclusive Angle	Cut Type				
	D1	L1	D2	L2	Deg °	Singlecut	Doublecut	Alumacut	Diamondcut	Chipbreaker
*	2.5	3	3	38	10°	SN-41MMSC	SN-41MMDC	SN-41MMFM	SN-41MMDM	SN-41MMCB
*	3	4	3	38	10°	SN-42MMSC	SN-42MMDC	SN-42MMFM	SN-42MMDM	SN-42MMCB
*	6	8	6	50	10°	SN-1MMSC	SN-1MMDC	SN-1MMFM	SN-1MMDM	SN-1MMCB
	6.3	6	3	44	10°	SN-51MMSC	SN-51MMDC	SN-51MMFM	SN-51MMDM	SN-51MMCB
	9.5	9.5	6	54.5	13°	SN-2MMSC	SN-2MMDC	SN-2MMFM	SN-2MMDM	SN-2MMCB
	12.7	12.7	6	57.7	28°	SN-4MMSC	SN-4MMDC	SN-4MMFM	SN-4MMDM	SN-4MMCB
	16	19	6	64	18°	SN-6MMSC	SN-6MMDC	SN-6MMFM	SN-6MMDM	SN-6MMCB
	19	16	6	61	30°	SN-7MMSC	SN-7MMDC	SN-7MMFM	SN-7MMDM	SN-7MMCB

* Solid Carbide • *全然 碳化物

FIBERGLASS ROUTERS

玻璃纤维专用锉铣刀

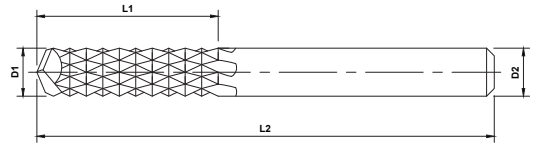
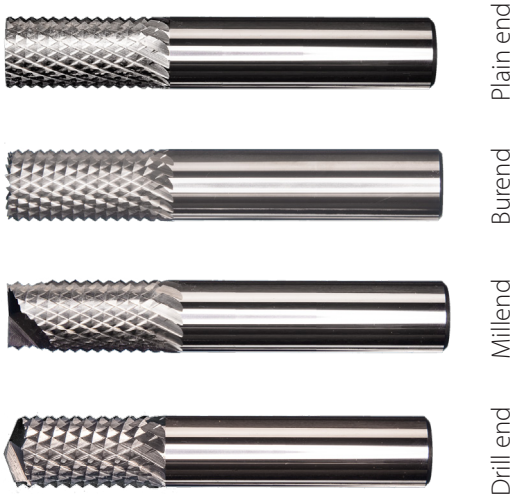

Length Key (K)

Standard Long * Solid Carbide

	OD	LOC	SHK	OAL	End Cut Type			
	D1	L1	D2	L2	Plain end(A)	Burend (B)	Millend (C)	Drill end (D)
Standard	2	10	3	38	FGRM1-1A	FGRM1-1B	FGRM1-1C	FGRM1-1D
	1.5	5	3	38	FGRM1A	FGRM1B	FGRM1C	FGRM1D
	3	12	3	38	FGRM2A	FGRM2B	FGRM2C	FGRM2D
	5	16	5	50	FGRM3A	FGRM3B	FGRM3C	FGRM3D
		16	6	50	FGRM4A	FGRM4B	FGRM4C	FGRM4D
	6	18	6	50	FGRM5A	FGRM5B	FGRM5C	FGRM5D
		25	6	63	FGRM6-0A	FGRM6-0B	FGRM6-0C	FGRM6-0D
		18	6	75	FGRM6-1A	FGRM6-1B	FGRM6-1C	FGRM6-1D
		25	6	75	FGRM6-2A	FGRM6-2B	FGRM6-2C	FGRM6-2D
		38	6	75	FGRM6-3A	FGRM6-3B	FGRM6-3C	FGRM6-3D
		18	6	63	FGRM6A	FGRM6B	FGRM6C	FGRM6D
	8	25	8	63	FGRM7A	FGRM7B	FGRM7C	FGRM7D
10	25	10	63	FGRM8A	FGRM8B	FGRM8C	FGRM8D	
12	25	12	75	FGRM9A	FGRM9B	FGRM9C	FGRM9D	

DIEMILLS

Diemills



Doublecut

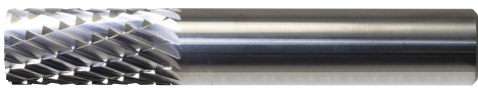

Coarse
Doublecut

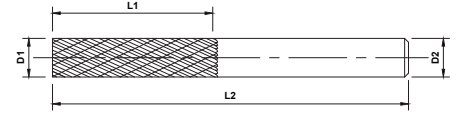

Length Key (K)

Standard Long * Solid Carbide



	OD	LOC	SHK	OAL	Cut Type	
	D1	L1	D2	L2	Doublecut	Coarse Doublecut
*	3	12	3	38	M48000	M48020
*	4	12	4	50	M48100	M48120
*	5	16	5	50	M48200	M48220
*	6	18	6	50	M48300	M48320
*	8	22	8	63	M48400	M48420
*	10	25	10	63	M48500	M48520

* Solid Carbide • *全然 碳化物

PILOTED DIEMILLS

Piloted Diemills

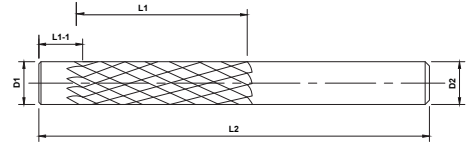

BURS

Length Key (K)

Standard Long * Solid Carbide



	OD	LOC	Pilot	SHK	OAL	Cut Type	
	D1	L1	L1-1	D2	L2	Doublecut	Singlecut
*	3	25	3	3	75	M22000	M22001
*	5	32	5	5	75	M22100	M22101
*	6	32	6	6	75	M22200	M22201
*	10	50	10	10	100	M22300	M22301
*	12	50	12	12	100	M22400	M22401

* Solid Carbide • *全然 碳化物

TIRE BURS

轮胎修理旋转文件

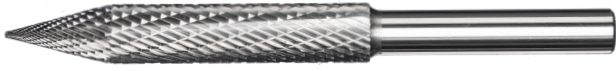
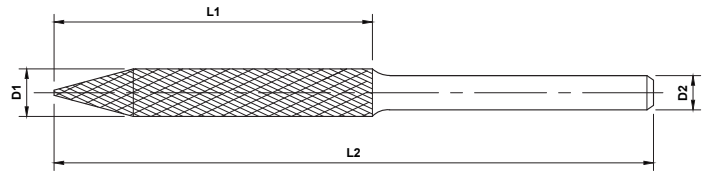

Round Shank

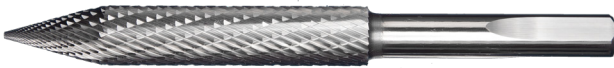

Tri-Shank

Length Key (K)

Standard Long * Solid Carbide

Steel
P

OD	LOC	SHK	OAL	Shank Type	
D1	L1	D2	L2	Round Shank	Tri-Shank
3	25	3	50	STBM-011	-
	14	3	38	STBM-012	STBM-012T
6	50	6	75	STBM-013	STBM-013T
8	53	8	100	STBM-014	STBM-014T
10	75	10	100	STBM-015	STBM-015T

PLASTIC POUCH BUR SETS

塑料袋装旋转锉组件



Power Pouch Bur Sets	
Part ID	Description
SETM640MMDC	Plastic Pouch Set SC3MML6, SD3MML6, SF3MML6, SF5MML6 Doublecut
SETM640MMDM	Plastic Pouch Set SC3MML6, SD3MML6, SF3MML6, SF5MML6 Diamond Cut
SETM640MMFM	Plastic Pouch Set SC3MML6, SD3MML6, SF3MML6, SF5MML6 Alumacut
SETM640MMSC	Plastic Pouch Set SC3MML6, SD3MML6, SF3MML6, SF5MML6 Singlecut

All tools in these sets are 6mm diameter shank. • 在这些组件中的所有工具的刀杆直径为6毫米

12 PIECE PLASTIC BOX BUR SETS

塑料盒装旋转锉组件



Plastic Box Bur Set			
SD	Burs Shapes Included	Cut Type	Part ID
3mm	SA43MM, SA42MM, SC42MM, SC41MM, SD42MM, SE41MM, SF41MM, SG41MM, SH41MM, SJ42MM, SL42MM, SN42MM	Doublecut	SETM100MMPDC
3mm	SA43MM, SA42MM, SC42MM, SC41MM, SD42MM, SE41MM, SF41MM, SG41MM, SH41MM, SJ42MM, SL42MM, SN42MM	Diamondcut	SETM100MMPDM
3mm	SA43MM, SA42MM, SC42MM, SC41MM, SD42MM, SE41MM, SF41MM, SG41MM, SH41MM, SJ42MM, SL42MM, SN42MM	Singlecut	SETM100MMPSC
6mm	SA1MM, SC1MM, SD1MM, SE1MM, SF1MM, SG1MM, SH1MM, SJ1MM, SK1MM, SL1MM, SM1MM, SN1MM	Doublecut	SETM120MMPDC
6mm	SA1MM, SC1MM, SD1MM, SE1MM, SF1MM, SG1MM, SH1MM, SJ1MM, SK1MM, SL1MM, SM1MM, SN1MM	Diamondcut	SETM120MMPDM
6mm	SA1MM, SC1MM, SD1MM, SE1MM, SF1MM, SG1MM, SH1MM, SJ1MM, SK1MM, SL1MM, SM1MM, SN1MM	Singlecut	SETM120MMPSC

SD= Shank Diameter • SD= 刀杆直径

24 PIECE COUNTERTOP DISPLAYS

24件套装展示盒



Description	Burs Included	Part Number
24 Piece Display Metric Bur Set	SA-5MMDC, SA-3MMDC, SA-1MMDC, SC-5MMDC, SC-3MMDC, SC-1MMDC, SD-5MMDC, SD-3MMDC, SD-1MMDC, SE-5MMDC, SE-3MMDC, SE-1MMDC, SF-5MMDC, SF-3MMDC, SF-1MMDC, SG-5MMDC, SG-3MMDC, SG-1MMDC, SL-4MMDC, SL-3MMDC, SL-1MMDC, SM-5MMDC, SM-4MMDC, SM-3MMDC	DISPLAY2M
24 Piece Metric Bur Set without Display	All Burs Above	DIS24M-ND

All tools in these sets are 6mm diameter shank. • 在这些组件中的所有刀具的刀杆直径为6毫米



FRACTIONAL PRODUCTS
具有英寸测量的产品

**“Our Best Selling Fractional
Dimension Tools!”**

我们最畅销的分数尺寸工具!

SUPERIOR CARBIDE BLEND

迈斯卡的超级硬质合金材质

Mastercut's Superior Carbide Blend – A-Gr-SiV (Active Grain Sized Volume)

Our superior tungsten carbide gives you the ability to be aggressive when you need to be. Growth inhibitors in our submicron carbide blanks maintain the most consistent grain size available, giving you superior hardness and toughness.

迈斯卡的超级硬质合金材质 - 拥有均匀亚微米晶粒，完美的硬度和韧性的结合，保证我们的刀具可以面对各种挑战时游刃有余。

Full line of fractional products available



































































































提供全系列的英制产品

LEGENDS

	Alumacuts recommended for non-ferrous materials
	Alumacuts建议用于 有色金属材料去毛刺















Fractional Products
具有英寸测量的产品

TABLE OF CONTENTS - 目录

	Fractional Square Endmills 平底铣刀160						
	Fractional Ball Endmills 球头铣刀161						
	Fractional Corner Radius Endmills 倒R角立铣刀162						
	Fractional 90° Drill Mills 90°钻铣刀163						
	Fractional Square End Mini Mills 平底微铣刀164						
	Fractional Ball End Mini Mills 球头微铣刀165						
	Fractional V4 Square Endmills V4平底铣刀166						
	Fractional V4 Ball Endmills V4球头铣刀167						
	Fractional V4 Corner Radius Endmills V4倒R角刀铣刀168						
	Fractional V5 Square Endmills V5平底铣刀169						
	Fractional V5 Ball Endmills V5球头铣刀170						
	Fractional V5 Corner Radius Endmills V5 倒R角铣刀171						
	Fractional F45 6 Flute Square Endmills F45,6刃平底铣刀172						
	Fractional F45 6 Flute Corner Radius Endmills F45, 6刃倒R角铣刀173						

Fractional Products
具有英寸测量的产品

TABLE OF CONTENTS - 目录

	Fractional Square End AxMills 铝合金专用Axmill平底铣刀 174									Non-Ferrous N
	Fractional Jobber Drills 2刃标准钻头 175	Cermet	Hardened H	Cast Iron K	Titanium S	Non-Ferrous N	Stainless M	Steel P		
	Fractional Spade Drills 扁铲钻. 178	Cermet	Hardened H	Cast Iron K	Titanium S	Non-Ferrous N	Stainless M	Steel P		
	Fractional NC Spotting Drills NC 定位钻 179	Cermet	Hardened H	Cast Iron K	Titanium S	Non-Ferrous N	Stainless M	Steel P		
	Fractional Drill and Countersink/Centerdrill 中心钻和沉孔钻 180	Cermet	Hardened H	Cast Iron K	Titanium S	Non-Ferrous N	Stainless M	Steel P		
	Fractional SA Bur - Cylindrical Shape without End Cut SA-园柱型,无端切旋转锉. 181		Hardened H	Cast Iron K		Non-Ferrous N	Stainless M	Steel P		
	Fractional SB Bur - Cylindrical with Endcut SB-园柱型,带端切旋转锉. 182		Hardened H	Cast Iron K		Non-Ferrous N	Stainless M	Steel P		
	Fractional SC Bur - Radius Cylindrical Shape SC-球头柱体型旋转锉. 183		Hardened H	Cast Iron K		Non-Ferrous N	Stainless M	Steel P		
	Fractional SD Bur - Ball Shape SD-球体型旋转锉 184		Hardened H	Cast Iron K		Non-Ferrous N	Stainless M	Steel P		
	Fractional SE Bur - Oval Shape SE-橄榄型旋转锉. 185		Hardened H	Cast Iron K		Non-Ferrous N	Stainless M	Steel P		
	Fractional SF Bur - Radius Tree Shape SF-圆顶树体型旋转锉 186		Hardened H	Cast Iron K		Non-Ferrous N	Stainless M	Steel P		
	Fractional SG Bur - Pointed Tree Shape SG-尖顶树体型旋转锉 187		Hardened H	Cast Iron K		Non-Ferrous N	Stainless M	Steel P		
	Fractional SH Bur - Flame Shape SH-尖顶树体型旋转锉 187		Hardened H	Cast Iron K		Non-Ferrous N	Stainless M	Steel P		
	Fractional SL Bur - Radius Cone Shape SL-圆顶锥体型旋转锉. 188		Hardened H	Cast Iron K		Non-Ferrous N	Stainless M	Steel P		
	Fractional SM Bur - Pointed Cone Shape SM-尖顶锥体型旋转锉. 189		Hardened H	Cast Iron K		Non-Ferrous N	Stainless M	Steel P		

Fractional Products
具有英寸测量的产品

SQUARE ENDMILLS

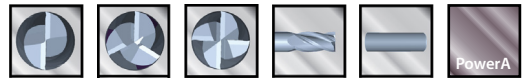

平底铣刀

2, 3 and 4 Flutes	Coated and Uncoated
2,3 &4刃系列;	涂层和无涂层

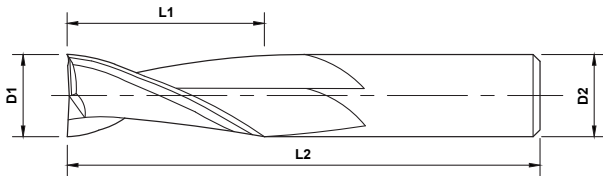

Standard, Series 209,210,211

Length Key (K)

Stub Standard Long

Quick Ship Items



OD	LOC	SHK	OAL	Uncoated			PowerA		
				2 Flute	3 Flute	4 Flute	2 Flute	3 Flute	4 Flute
D1	L1	D2	L2						
1/32	3/32	1/8	1-1/2	209-202	-	211-202	209-202-1	-	211-202-1
1/16	1/4	1/8	1-1/2	209-206	-	211-206	209-206-1	-	211-206-1
3/32	3/8	1/8	1-1/2	209-210	-	211-210	209-210-1	-	211-210-1
1/8	1/2	1/8	1-1/2	209-214	-	211-214	209-214-1	-	211-214-1
3/16	5/8	3/16	2	209-222	-	211-222	209-222-1	-	211-222-1
1/4	3/4	1/4	2-1/2	209-230	210-230	211-230	209-230-1	210-230-1	211-230-1
5/16	7/8	5/16	2-1/2	209-238	-	211-238	209-238-1	-	211-238-1
3/8	7/8	3/8	2-1/2	209-246	210-246	211-246	209-246-1	210-246-1	211-246-1
1/2	1	1/2	3	209-262	210-262	211-262	209-262-1	210-262-1	211-262-1
5/8	1-1/4	5/8	3-1/2	209-266	-	211-266	209-266-1	-	211-266-1
3/4	1-1/2	3/4	4	209-270	-	211-270	209-270-1	-	211-270-1
7/8	1-1/2	7/8	4	209-272	-	211-272	209-272-1	-	211-272-1
1	1-1/2	1	4	209-274	-	211-274	209-274-1	-	211-274-1

Fractional Products

具有英寸测量的产品

BALL ENDMILLS

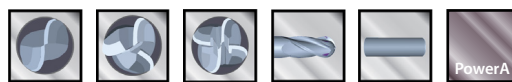

球头铣刀

2, 3 and 4 Flutes	Coated and Uncoated
2,3 &4刃系列;	涂层和无涂层

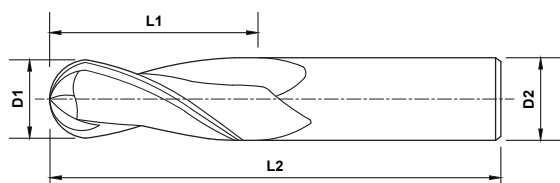

Standard, Series 209,210,211

Length Key (K)

■ Stub
 ■ Standard
 ■ Long

Quick Ship Items

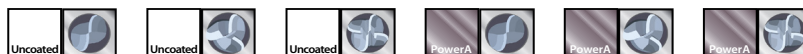

	OD	LOC	SHK	OAL	Uncoated			PowerA		
					2 Flute	3 Flute	4 Flute	2 Flute	3 Flute	4 Flute
	D1	L1	D2	L2						
	1/32	3/32	1/8	1-1/2	209-002	-	211-002	209-002-1	-	211-002-1
	1/16	1/4	1/8	1-1/2	209-006	-	211-006	209-006-1	-	211-006-1
	3/32	3/8	1/8	1-1/2	209-010	-	211-010	209-010-1	-	211-010-1
	1/8	1/2	1/8	1-1/2	209-014	-	211-014	209-014-1	-	211-014-1
	3/16	5/8	3/16	2	209-022	-	211-022	209-022-1	-	211-022-1
	1/4	3/4	1/4	2-1/2	209-030	210-030	211-030	209-030-1	210-030-1	211-030-1
	5/16	7/8	5/16	2-1/2	209-038	-	211-038	209-038-1	-	211-038-1
	3/8	7/8	3/8	2-1/2	209-046	210-046	211-046	209-046-1	210-046-1	211-046-1
	1/2	1	1/2	3	209-062	210-062	211-062	209-062-1	210-062-1	211-062-1
	5/8	1-1/4	5/8	3-1/2	209-066	-	211-066	209-066-1	-	211-066-1
	3/4	1-1/2	3/4	4	209-070	-	211-070	209-070-1	-	211-070-1
	7/8	1-1/2	7/8	4	209-072	-	211-072	209-072-1	-	211-072-1
	1	1-1/2	1	4	209-074	-	211-074	209-074-1	-	211-074-1

Fractional Products
具有英寸测量的产品

CORNER RADIUS ENDMILLS

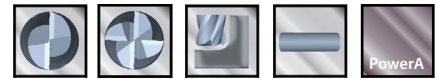

倒R角立铣刀

2 and 4 Flutes	Coated and Uncoated
2 & 4刃系列:	涂层和无涂层

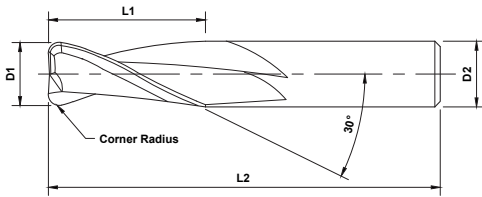

Standard, Series 209,211

Length Key (K)

■ Stub
 ■ Standard
 ■ Long

Quick Ship Items



	OD	LOC	SHK	OAL	Radius	Uncoated		PowerA	
						2 Flute	4 Flute	2 Flute	4 Flute
	D1	L1	D2	L2	R				
1/8		1/2	1/8	1-1/2	.015	209-401	211-401	209-401-1	211-401-1
		1/2	1/8	1-1/2	.020	209-402	211-402	209-402-1	211-402-1
3/16		5/8	3/16	2	.015	209-411	211-411	209-411-1	211-411-1
		5/8	3/16	2	.020	209-412	211-412	209-412-1	211-412-1
1/4		3/4	1/4	2-1/2	.015	209-421	211-421	209-421-1	211-421-1
		3/4	1/4	2-1/2	.020	209-422	211-422	209-422-1	211-422-1
		3/4	1/4	2-1/2	.030	209-423	211-423	209-423-1	211-423-1
5/16		13/16	5/16	2-1/2	.020	209-432	211-432	209-432-1	211-432-1
		13/16	5/16	2-1/2	.030	209-433	211-433	209-433-1	211-433-1
3/8		1	3/8	2-1/2	.020	209-442	211-442	209-442-1	211-442-1
		1	3/8	2-1/2	.030	209-443	211-443	209-443-1	211-443-1
1/2		1	1/2	3	.020	209-452	211-452	209-452-1	211-452-1
		1	1/2	3	.030	209-453	211-453	209-453-1	211-453-1
5/8		1-1/4	5/8	3-1/2	.030	209-463	211-463	209-463-1	211-463-1
		1-1/4	5/8	3-1/2	.045	209-464	211-464	209-464-1	211-464-1
3/4		1-1/2	3/4	4	.030	209-473	211-473	209-473-1	211-473-1
		1-1/2	3/4	4	.045	209-474	211-474	209-474-1	211-474-1
1		1-1/2	1	4	.030	209-483	211-483	209-483-1	211-483-1
		1-1/2	1	4	.045	209-484	211-484	209-484-1	211-484-1

Fractional Products

具有英寸测量的产品

90° DRILL MILLS

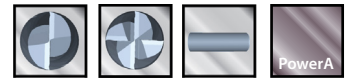

90°钻铣刀

2 and 4 Flutes	Coated and Uncoated
2 & 4刃系列;	涂层和无涂层

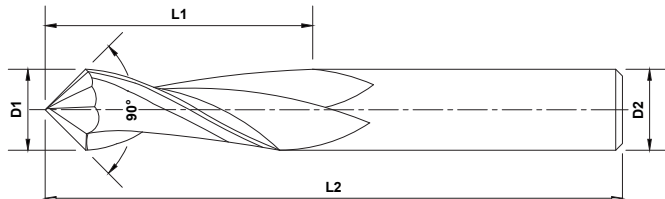

Standard, Series 214

Length Key (K)

■ Stub
 ■ Standard
 ■ Long

Quick Ship Items



	OD	LOC	SHK	OAL	Uncoated		PowerA	
					2 Flute	4 Flute	2 Flute	4 Flute
	D1	L1	D2	L2				
■	1/4	3/4	1/4	2-1/2	214-006	214-306	214-006-1	214-306-1
	3/8	7/8	3/8	2-1/2	214-010	214-310	214-010-1	214-310-1
	1/2	1	1/2	3	214-014	214-314	214-014-1	214-314-1

Fractional Products
具有英寸测量的产品

SQUARE MINI MILLS

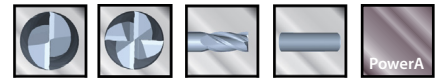

平底微铣刀

2 and 4 Flutes	Coated and Uncoated
2 & 4刃系列;	涂层和无涂层

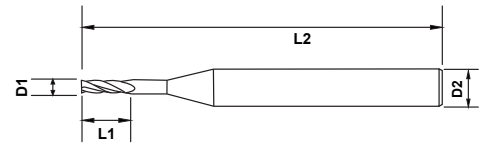
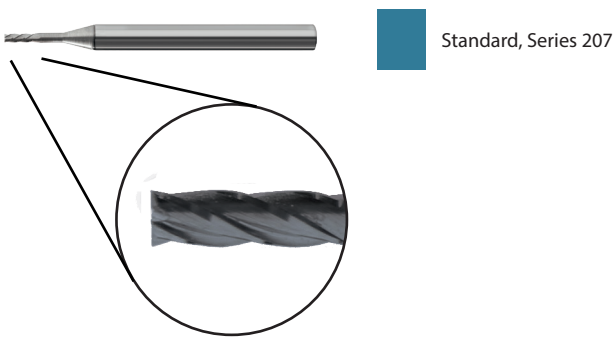

Length Key (K)

■ Stub
 ■ Standard
 ■ Long



	OD	LOC	SHK	OAL	Uncoated		PowerA	
	D1	L1	D2	L2	2 Flute	4 Flute	2 Flute	4 Flute
	.010	.030	1/8	1-1/2	207-104	-	207-104-1	-
	.015	.045	1/8	1-1/2	207-106	-	207-106-1	-
	.020	.060	1/8	1-1/2	207-108	-	207-108-1	-
	.025	.075	1/8	1-1/2	207-110	207-510	207-110-1	207-510-1
	.030	.090	1/8	1-1/2	207-112	207-512	207-112-1	207-512-1
	.035	.105	1/8	1-1/2	207-114	207-514	207-114-1	207-514-1
	.040	.120	1/8	1-1/2	207-116	207-516	207-116-1	207-516-1
	.045	.135	1/8	1-1/2	207-118	207-518	207-118-1	207-518-1
	.050	.174	1/8	1-1/2	207-120	207-520	207-120-1	207-520-1
	.055	.267	1/8	1-1/2	207-122	207-522	207-122-1	207-522-1
	.060	.360	1/8	1-1/2	207-124	207-524	207-124-1	207-524-1

Fractional Products

具有英寸测量的产品

BALL MINI MILLS

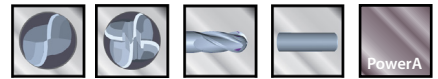

球头微铣刀

2 and 4 Flutes	Coated and Uncoated
2 & 4刀系列;	涂层和无涂层

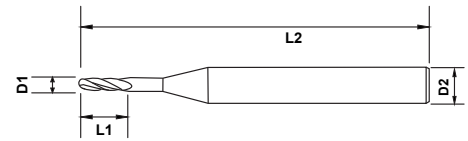
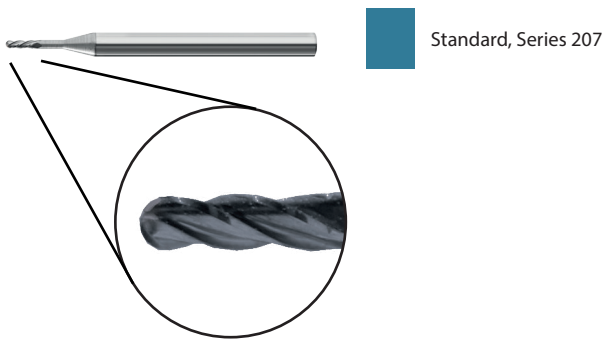

Length Key (K)

■ Stub
 ■ Standard
 ■ Long



	OD	LOC	SHK	OAL	Uncoated		PowerA	
					2 Flute	4 Flute	2 Flute	4 Flute
	D1	L1	D2	L2	2 Flute	4 Flute	2 Flute	4 Flute
Length Key (K)	.010	.030	1/8	1-1/2	207-004	-	207-004-1	-
	.015	.045	1/8	1-1/2	207-006	-	207-006-1	-
	.020	.060	1/8	1-1/2	207-008	-	207-008-1	-
	.025	.075	1/8	1-1/2	207-010	207-410	207-010-1	207-410-1
	.030	.090	1/8	1-1/2	207-012	207-412	207-012-1	207-412-1
	.035	.105	1/8	1-1/2	207-014	207-414	207-014-1	207-414-1
	.040	.120	1/8	1-1/2	207-016	207-416	207-016-1	207-416-1
	.045	.135	1/8	1-1/2	207-018	207-418	207-018-1	207-418-1
	.050	.174	1/8	1-1/2	207-020	207-420	207-020-1	207-420-1
	.055	.267	1/8	1-1/2	207-022	207-422	207-022-1	207-422-1
	.060	.360	1/8	1-1/2	207-024	207-424	207-024-1	207-424-1

Fractional Products
具有英寸测量的产品

V4 SQUARE ENDMILLS

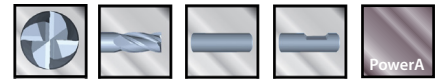

V4平底铣刀

4 Flutes 4刃	Coated with or without flat 涂层, 普通刀杆和侧固刀杆
----------------	--

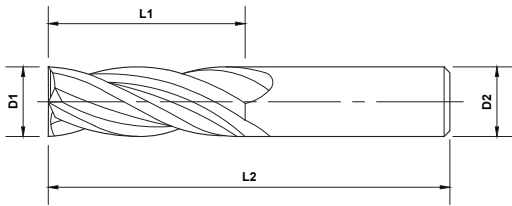

PowerA



Standard, Series 400

Length Key (K)



Quick Ship Items



	OD	LOC	SHK	OAL	PowerA	
					No Flat	With Flat
	D1	L1	D2	L2		
	1/4	5/8	1/4	2-1/2	400-010-1	-
	5/16	13/16	5/16	2-1/2	400-012-1	-
	3/8	7/8	3/8	2-1/2	400-016-1	400-016W-1
	1/2	1	1/2	3	400-022-1	400-022W-1
	5/8	1-1/4	5/8	3-1/2	400-028-1	400-028W-1
	3/4	1-1/2	3/4	4	400-030-1	400-030W-1

Fractional Products

具有英寸测量的产品

V4 BALL ENDMILLS



V4球头铣刀

4 Flutes 4刃	Coated with or without flat 涂层, 普通刀杆和侧固刀杆
----------------	--

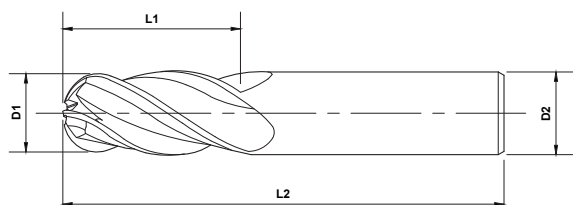

PowerA

Standard, Series 400

Length Key (K)

Stub Standard Long

Quick Ship Items



	OD	LOC	SHK	OAL	PowerA	
					No Flat	With Flat
	D1	L2	D2	L2		
	1/4	5/8	1/4	2-1/2	400-210-1	-
	5/16	13/16	5/16	2-1/2	400-212-1	-
	3/8	7/8	3/8	2-1/2	400-216-1	400-216W-1
	1/2	1	1/2	3	400-222-1	400-222W-1
	5/8	1-1/4	5/8	3-1/2	400-228-1	400-228W-1
	3/4	1-1/2	3/4	4	400-230-1	400-230W-1
	1	1-1/2	1	4	400-234-1	400-234W-1

Fractional Products
具有英寸测量的产品

V4 CORNER RADIUS ENDMILLS

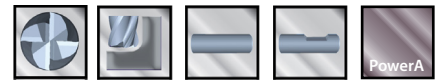

V4倒R角刀铣刀

4 Flutes	Coated with or without flat
4刃	涂层, 普通刀杆和侧固刀杆

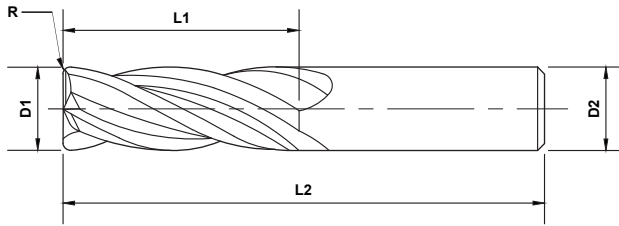

PowerA

Standard, Series 400

Length Key (K)

Stub Standard Long

Quick Ship Items



	OD	LOC	SHK	OAL	Radius	PowerA	
	D1	L1	D2	L2	R	No Flat	With Flat
1/4	5/8	5/8	1/4	2-1/2	.015	400-421-1	-
			1/4	2-1/2	.020	400-422-1	-
5/16	13/16	13/16	5/16	2-1/2	.015	400-431-1	-
			5/16	2-1/2	.020	400-432-1	-
3/8	7/8	7/8	3/8	2-1/2	.020	400-442-1	400-442W-1
			3/8	2-1/2	.030	400-443-1	400-443W-1
1/2	1	1	1/2	3	.020	400-462-1	400-462W-1
			1/2	3	.030	400-463-1	400-463W-1
5/8	1-1/4	1-1/4	5/8	3-1/2	.020	400-492-1	400-492W-1
			5/8	3-1/2	.030	400-493-1	400-493W-1
3/4	1-1/2	1-1/2	3/4	4	.030	400-503-1	400-503W-1
			3/4	4	.045	400-504-1	400-504W-1

Fractional Products

具有英寸测量的产品

V5 SQUARE ENDMILLS

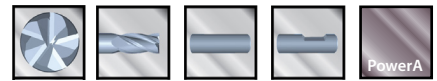

V5平底铣刀

5 Flutes	Coated with or without flat
5刃	涂层, 普通刀杆和侧固刀杆

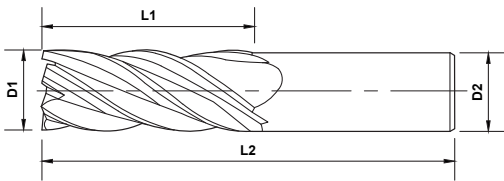

PowerA

Standard, Series 408

Length Key (K)

Stub Standard Long

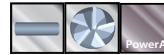

	OD	LOC	SHK	OAL	PowerA	
					No Flat	With Flat
	D1	L1	D2	L2		
	3/8	7/8	3/8	2-1/2	408-010-1	408-010W-1
	1/2	1	1/2	3	408-014-1	408-014W-1
	5/8	1-1/4	5/8	3-1/2	408-020-1	408-020W-1
	3/4	1-1/2	3/4	4	408-024-1	408-024W-1
	1	1-1/2	1	4	408-026-1	408-026W-1

Fractional Products
具有英寸测量的产品

V5 BALL ENDMILLS

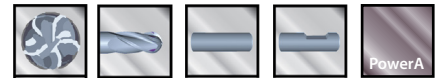

V5球头铣刀

5 Flutes	Coated with or without flat
5刃	涂层, 普通刀杆和侧固刀杆

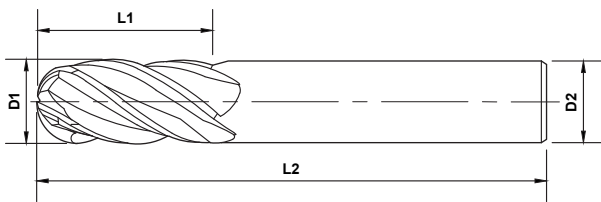

PowerA

Length Key (K)

■ Stub
 ■ Standard
 ■ Long



	OD	LOC	SHK	OAL	PowerA	
	D1	L1	D2	L2	No Flat	With Flat
Standard	3/8	7/8	3/8	2-1/2	408-210-1	408-210W-1
	1/2	1	1/2	3	408-214-1	408-214W-1
	5/8	1-1/4	5/8	3-1/2	408-220-1	408-220W-1
	3/4	1-1/2	3/4	4	408-222-1	408-222W-1
	1	1-1/2	1	4	408-226-1	408-226W-1

Fractional Products

具有英寸测量的产品

V5 CORNER RADIUS ENDMILLS

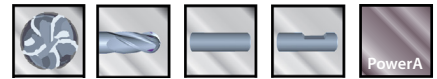

V5 倒R角铣刀

5 Flutes	Coated with or without flat
5刃	涂层, 普通刀杆和侧固刀杆

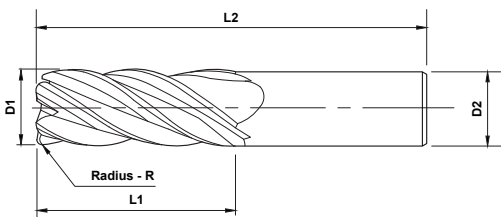

PowerA

Standard, Series 408

Length Key (K)

■ Stub
 ■ Standard
 ■ Long



	OD	LOC	SHK	OAL	Radius	PowerA	
	D1	L1	D2	L2	R	No Flat	With Flat
3/8		7/8	3/8	2-1/2	.015	408-441-1	408-441W-1
		7/8	3/8	2-1/2	.020	408-442-1	408-442W-1
1/2		1	1/2	3	.020	408-462-1	408-462W-1
		1	1/2	3	.030	408-463-1	408-463W-1
5/8		1-1/4	5/8	3-1/2	.020	408-492-1	408-492W-1
		1-1/4	5/8	3-1/2	.030	408-493-1	408-493W-1
3/4		1-1/2	3/4	4	.030	408-503-1	408-503W-1
		1-1/2	3/4	4	.045	408-504-1	408-504W-1
1		1-1/2	1	4	.030	408-523-1	408-523W-1
		1-1/2	1	4	.045	408-524-1	408-524W-1

Fractional Products
具有英寸测量的产品

F45 6 FLUTE SQUARE ENDMILLS

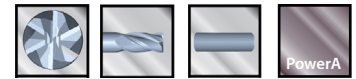

F45,6刃平底铣刀

6 Flutes	Coated and Uncoated
6刃	涂层和无涂层

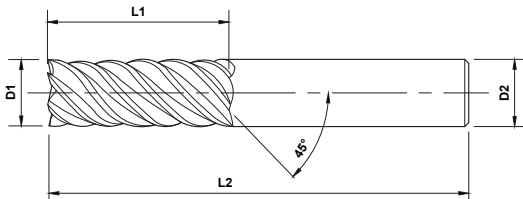

Uncoated

Standard, Series 411



PowerA

Standard, Series 411

Length Key (K)

■ Stub
 ■ Standard
 ■ Long



	OD	LOC	SHK	OAL	Uncoated	PowerA
	D1	L1	D2	L2	Part ID	Part ID
	3/8	1	3/8	2-1/2	411-008	411-008-1
	1/2	1	1/2	3	411-012	411-012-1
	5/8	1-1/4	5/8	3-1/2	411-016	411-016-1
	3/4	1-1/2	3/4	4	411-018	411-018-1
	1	1-1/2	1	4	411-022	411-022-1

Fractional Products

具有英寸测量的产品

F45 6 FL CORNER RADIUS ENDMILLS



F45, 6刃倒R角铣刀

6 Flutes	Coated and Uncoated
6刃	涂层和无涂层

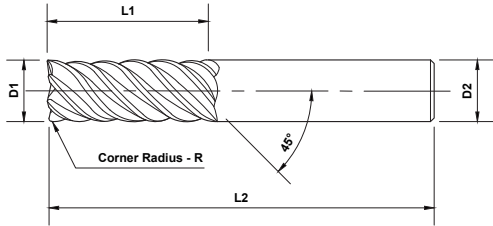

Uncoated

Standard, Series 411

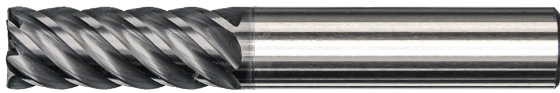

PowerA

Standard, Series 411

Length Key (K)

■ Stub
 ■ Standard
 ■ Long



Uncoated



PowerA

	OD	LOC	SHK	OAL	Radius	Uncoated	PowerA
	D1	L1	D2	L2	R	Part ID	Part ID
	3/8	1	3/8	2-1/2	.012	411-220	411-220-1
	1/2	1	1/2	3	.015	411-241	411-241-1
	5/8	1-1/4	5/8	3-1/2	.020	411-262	411-262-1
	3/4	1-1/2	3/4	4	.030	411-273	411-273-1
	1	1-1/2	1	4	.030	411-293	411-293-1

Fractional Products
具有英寸测量的产品

SQUARE END AXMILLS

铝合金专用Axmill平底铣刀

2 and 3 Flutes	Coated and Uncoated
2 & 3刃系列;	涂层和无涂层

Non-Ferrous
N

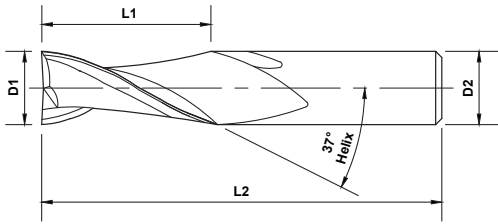

Uncoated

Standard, Series 411



PowerZ

Standard, Series 411

Length Key (K)

Stub
 Standard
 Long

Quick Ship Items



OD	LOC	SHK	OAL	Uncoated	PowerZ	Uncoated	PowerZ
D1	L1	D2	L2	2 Flute	2 Flute	3 Flute	3 Flute
1/4	3/4	1/4	2-1/2	414-008	414-008-4	420-008	420-008-4
	1	1/4	2-1/2	414-010	414-010-4	420-010	420-010-4
	1-1/8	1/4	2-1/2	-	-	421-082	421-082-4
3/8	7/8	3/8	2-1/2	414-016	414-016-4	420-016	420-016-4
	1	3/8	2-1/2	414-018	414-018-4	420-018	420-018-4
1/2	1	1/2	3	414-022	414-022-4	420-022	420-022-4
	1-1/4	1/2	3	414-024	414-024-4	420-024	420-024-4
5/8	1-1/4	5/8	3-1/2	414-028	414-028-4	420-028	420-028-4
	1-1/2	3/4	4	414-032	414-032-4	420-032	420-032-4
3/4	1-3/4	3/4	4	414-034	414-034-4	420-034	420-034-4
	1-1/4	1	5	-	-	421-164	421-164-4
1	1-1/2	1	5	-	-	421-166	421-166-4

Fractional Products

具有英寸测量的产品

JOBBER DRILLS

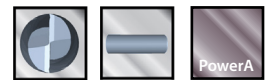

2刃标准钻头

2 Flute	118° Four Facet Point	Coated and Uncoated
2刃	118°四面尖•无涂层	涂层和无涂层

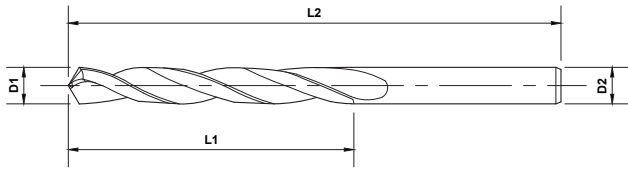

Uncoated

Length Key (K)

■ Stub
 ■ Standard
 ■ Long



OD	LOC	SHK	OAL	Wire	Uncoated	PowerA
D1	L1	D2	L2	Letter	Part ID	Part ID
1/8	1-1/4	1/8	2-1/4		601-104	601-104-1
.1285	1-3/8	.1285	2-1/2	30	601-106	601-106-1
.1360	1-3/8	.1360	2-1/2	29	601-108	601-108-1
.1378	1-3/8	.1378	2-1/2		601-110	601-110-1
.1405	1-3/8	.1405	2-1/2	28	601-112	601-112-1
9/64	1-3/8	9/64	2-1/2		601-114	601-114-1
.1440	1-3/8	.1440	2-1/2	27	601-116	601-116-1
.1470	1-3/8	.1470	2-1/2	26	601-118	601-118-1
.1495	1-3/8	.1495	2-1/2	25	601-120	601-120-1
.1520	1-3/8	.1520	2-1/2	24	601-122	601-122-1
.1540	1-3/8	.1540	2-1/2	23	601-124	601-124-1
5/32	1-3/8	5/32	2-1/2		601-126	601-126-1
.1570	1-3/8	.1570	2-1/2	22	601-128	601-128-1
.1575	1-3/8	.1575	2-1/2		601-130	601-130-1
.1590	1-3/8	.1590	2-1/2	21	601-132	601-132-1
.1610	1-3/8	.1610	2-1/2	20	601-134	601-134-1
.1660	1-5/8	.1660	2-3/4	19	601-136	601-136-1
.1695	1-5/8	.1695	2-3/4	18	601-138	601-138-1
11/64	1-5/8	11/64	2-3/4		601-140	601-140-1
.1730	1-5/8	.1730	2-3/4	17	601-142	601-142-1
.1770	1-5/8	.1770	2-3/4	16	601-144	601-144-1
.1772	1-5/8	.1772	2-3/4		601-146	601-146-1

Fractional Products
具有英寸测量的产品

JOBBER DRILLS

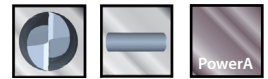

2刃标准钻头



OD	LOC	SHK	OAL	Wire	Uncoated	PowerA
D1	L1	D2	L2	Letter	Part ID	Part ID
.1800	1-5/8	.1800	2-3/4	15	601-148	601-148-1
.1820	1-5/8	.1820	2-3/4	14	601-150	601-150-1
.1850	1-5/8	.1850	2-3/4	13	601-152	601-152-1
3/16	1-5/8	3/16	2-3/4		601-154	601-154-1
.1890	1-5/8	.1890	2-3/4	12	601-156	601-156-1
.1910	1-5/8	.1910	2-3/4	11	601-158	601-158-1
.1935	1-5/8	.1935	2-3/4	10	601-160	601-160-1
.1960	1-3/4	.1960	3	9	601-162	601-162-1
.1968	1-3/4	.1968	3		601-164	601-164-1
.1990	1-3/4	.1990	3	8	601-166	601-166-1
.2010	1-3/4	.2010	3	7	601-168	601-168-1
13/64	1-3/4	13/64	3		601-170	601-170-1
.2040	1-3/4	.2040	3	6	601-172	601-172-1
.2055	1-3/4	.2055	3	5	601-174	601-174-1
.2090	1-3/4	.2090	3	4	601-176	601-176-1
.2130	1-3/4	.2130	3	3	601-178	601-178-1
.2165	1-3/4	.2165	3		601-180	601-180-1
7/32	1-3/4	7/32	3		601-182	601-182-1
.2210	1-3/4	.2210	3	2	601-184	601-184-1
.2280	1-3/4	.2280	3	1	601-186	601-186-1
.2340	2	.2340	3-1/4	A	601-188	601-188-1
15/64	2	15/64	3-1/4		601-190	601-190-1
.2362	2	.2362	3-1/4		601-192	601-192-1
.2380	2	.2380	3-1/4	B	601-194	601-194-1
.2420	2	.2420	3-1/4	C	601-196	601-196-1
.2460	2	.2460	3-1/4	D	601-198	601-198-1
1/4	2	1/4	3-1/4	E	601-200	601-200-1
.2559	2	.2559	3-1/4		601-202	601-202-1
.2570	2	.2570	3-1/4	F	601-204	601-204-1
.2610	2-1/8	.2610	3-1/2	G	601-206	601-206-1
17/64	2-1/8	17/64	3-1/2		601-208	601-208-1
.2660	2-1/8	.2660	3-1/2	H	601-210	601-210-1
.2720	2-1/8	.2720	3-1/2	I	601-212	601-212-1
.2756	2-1/8	.2756	3-1/2		601-214	601-214-1
.2770	2-1/8	.2770	3-1/2	J	601-216	601-216-1
.2810	2-1/8	.2810	3-1/2	K	601-218	601-218-1
9/32	2-1/8	9/32	3-1/2		601-220	601-220-1
.2900	2-1/8	.2900	3-1/2	L	601-222	601-222-1

Fractional Products
具有英寸测量的产品

JOBBER DRILLS

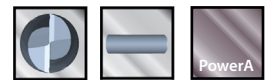

2刃标准钻头



OD	LOC	SHK	OAL	Wire	Uncoated	PowerA
D1	L1	D2	L2	Letter	Part ID	Part ID
.2950	2-3/8	.2950	4	M	601-224	601-224-1
.2953	2-3/8	.2953	4		601-226	601-226-1
19/64	2-3/8	19/64	4		601-228	601-228-1
.3020	2-3/8	.3020	4	N	601-230	601-230-1
5/16	2-3/8	5/16	4		601-232	601-232-1
.3150	2-3/8	.3150	4		601-234	601-234-1
.3160	2-3/8	.3160	4	O	601-236	601-236-1
.3230	2-3/8	.3230	4	P	601-238	601-238-1
21/64	2-3/8	21/64	4		601-240	601-240-1
.3320	2-3/8	.3320	4	Q	601-242	601-242-1
.3346	2-3/8	.3346	4		601-244	601-244-1
.3390	2-3/8	.3390	4	R	601-246	601-246-1
11/32	2-3/8	11/32	4		601-248	601-248-1
.3480	2-3/8	.3480	4	S	601-250	601-250-1
.3543	2-3/4	.3543	4-1/4		601-252	601-252-1
.3580	2-3/4	.3580	4-1/4	T	601-254	601-254-1
23/64	2-3/4	23/64	4-1/4		601-256	601-256-1
.3680	2-3/4	.3680	4-1/4	U	601-258	601-258-1
.3740	2-3/4	.3740	4-1/4		601-260	601-260-1
3/8	2-3/4	3/8	4-1/4		601-262	601-262-1
.3770	2-3/4	.3770	4-1/4	V	601-264	601-264-1
.3860	2-7/8	.3860	4-1/2	W	601-266	601-266-1
25/64	2-7/8	25/64	4-1/2		601-268	601-268-1
.3937	2-7/8	.3937	4-1/2		601-270	601-270-1
.3970	2-7/8	.3970	4-1/2	X	601-272	601-272-1
.4040	2-7/8	.4040	4-1/2	Y	601-274	601-274-1
13/32	2-7/8	13/32	4-1/2		601-276	601-276-1
.4130	2-7/8	.4130	4-1/2	Z	601-278	601-278-1
.4134	2-7/8	.4134	4-1/2		601-280	601-280-1
27/64	2-7/8	27/64	4-1/2		601-282	601-282-1
.4331	2-7/8	.4331	4-1/2		601-284	601-284-1
7/16	2-7/8	7/16	4-1/2		601-286	601-286-1
.4527	3	.4527	4-3/4		601-288	601-288-1
29/64	3	29/64	4-3/4		601-290	601-290-1
15/32	3	15/32	4-3/4		601-292	601-292-1
.4724	3	.4724	4-3/4		601-294	601-294-1
31/64	3	31/64	4-3/4		601-296	601-296-1
.4921	3	.4921	4-3/4		601-298	601-298-1
1/2	3	1/2	4-3/4		601-300	601-300-1

IMPERIAL PRODUCTS

Fractional Products
具有英寸测量的产品



SPADE DRILLS

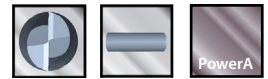

扁铲钻

2 Flutes	118° Point	Coated and Uncoated
2 刃系列;	118°尖	涂层和无涂层

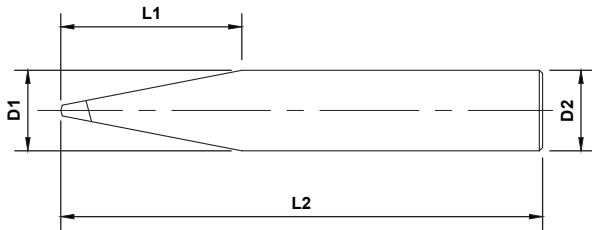
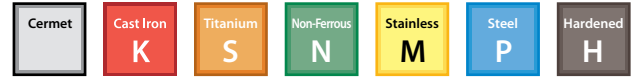

Uncoated

Length Key (K)

■ Stub
 ■ Standard
 ■ Long



	OD	LOC	SHK	OAL	Uncoated	PowerA
	D1	L1	D2	L2	Part ID	Part ID
■	1/32	3/16	1/32	1-1/2	600-002	600-002-1
■	1/16	5/16	1/16	1-1/2	600-004	600-004-1
■	3/32	3/8	3/32	1-1/2	600-006	600-006-1
■	1/8	7/16	1/8	1-1/2	600-008	600-008-1
■	5/32	15/32	5/32	2	600-010	600-010-1
■	3/16	9/16	3/16	2	600-012	600-012-1
■	7/32	19/32	7/32	2	600-014	600-014-1
■	1/4	11/16	1/4	2	600-016	600-016-1
■	9/32	3/4	9/32	2-1/2	600-018	600-018-1
■	5/16	7/8	5/16	2-1/2	600-020	600-020-1
■	3/8	1	3/8	2-1/2	600-022	600-022-1
■	7/16	1-1/4	7/16	2-1/2	600-024	600-024-1
■	1/2	1-3/8	1/2	2-1/2	600-026	600-026-1

Fractional Products

具有英寸测量的产品

NC SPOTTING DRILLS

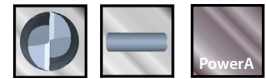

NC 定位钻

2 Flutes	90°, 120° and 142°	Coated and Uncoated
2 刃系列;	90°, 120°, 142°尖	涂层和无涂层

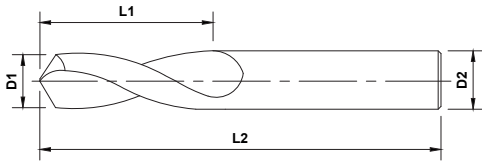

Uncoated

Length Key (K)

■ Stub
 ■ Standard
 ■ Long



	OD	LOC	SHK	OAL	Uncoated			PowerA		
					90°	120°	142°	90°	120°	142°
	D1	L1	D2	L2	90°	120°	142°	90°	120°	142°
K	1/8	3/8	1/8	2	600-402	600-502	600-602	600-402-1	600-502-1	600-602-1
	3/16	3/4	3/16	3	600-404	600-504	600-604	600-404-1	600-504-1	600-604-1
	1/4	3/4	1/4	3	600-406	600-506	600-606	600-406-1	600-506-1	600-606-1
	5/16	1	5/16	2-1/2	600-408	600-508	600-608	600-408-1	600-508-1	600-608-1
	3/8	1	3/8	3	600-410	600-510	600-610	600-410-1	600-510-1	600-610-1
	1/2	1	1/2	4	600-412	600-512	600-612	600-412-1	600-512-1	600-612-1

Fractional Products
具有英寸测量的产品

DRILL AND COUNTERSINK

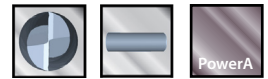

中心钻和沉孔钻

2 Flutes	118° Point	Coated and Uncoated
2 刃系列;	118°尖	涂层和无涂层

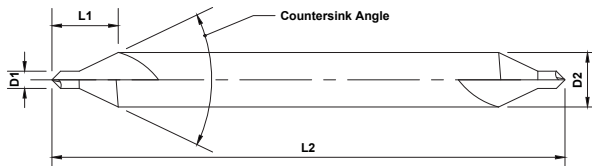
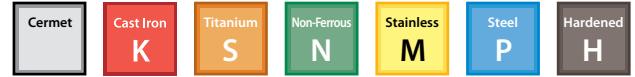

Uncoated

Length Key (K)

■ Stub
 ■ Standard
 ■ Long



	OD	LOC	SHK	OAL	Uncoated			PowerA		
					60°	82°	90°	60°	82°	90°
	D1	L1	D2	L2						
K	3/64	3/64	1/8	1-1/2	600-304	600-104	600-204	600-304-1	600-104-1	600-204-1
	5/64	5/64	3/16	2	600-306	600-106	600-206	600-306-1	600-106-1	600-206-1
	7/64	7/64	1/4	2	600-308	600-108	600-208	600-308-1	600-108-1	600-208-1
	1/8	1/8	5/16	2-1/8	600-310	600-110	600-210	600-310-1	600-110-1	600-210-1
	3/16	3/16	7/16	2-3/4	600-312	600-112	600-212	600-312-1	600-112-1	600-212-1
	7/32	7/32	1/2	3	600-314	600-114	600-214	600-314-1	600-114-1	600-214-1
	1/4	1/4	5/8	3-1/8	600-316	600-116	600-216	600-316-1	600-116-1	600-216-1
	5/16	5/16	3/4	3-3/8	600-318	600-118	600-218	600-318-1	600-118-1	600-218-1

Fractional Products

具有英寸测量的产品

SA BURS - CYLINDRICAL SHAPE WITHOUT END CUT

SA-园柱型,无端切旋转锉

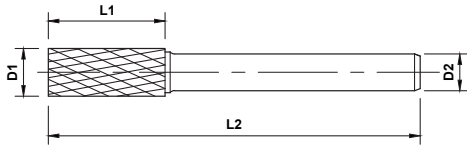

Non-Ferrous **N** Alumacuts recommended for non-ferrous materials

Cast Iron **K** Titanium **S** Stainless **M** Steel **P** Hardened **H**

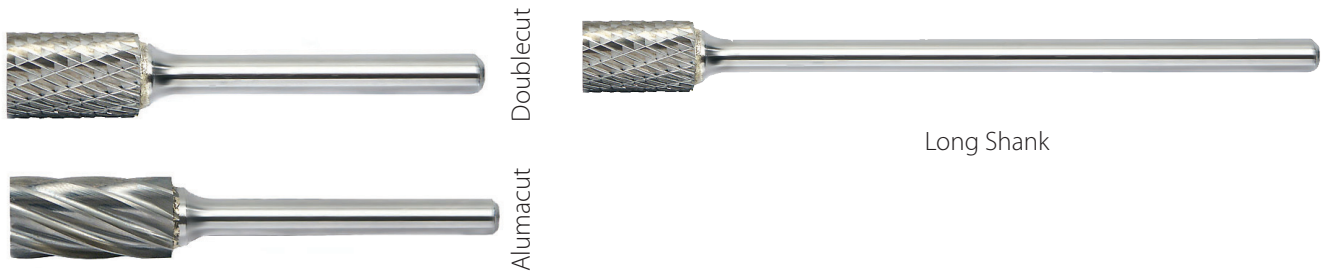

Length Key (K)



Quick Ship Items

	OD	LOC	SHK	OAL	Cut Type	
	D1	L1	D2	L2	Doublecut	Alumacut
*	1/8	9/16	1/8	1-1/2	SA-43DC	-
*	1/4	5/8	1/4	2	SA-1DC	SA-1FM
	3/8	3/4	1/4	2-1/2	SA-3DC	SA-3FM
		3/4	1/4	6-3/4	SA-3L6DC	SA-3L6FM
	1/2	1	1/4	2-3/4	SA-5DC	SA-5FM
		1	1/4	7	SA-5L6DC	SA-5L6FM

* Solid Carbide • *全然 碳化物

Fractional Products
具有英寸测量的产品

SB BURS - CYLINDRICAL SHAPE WITH END CUT

SB-园柱型,带端切旋转锉

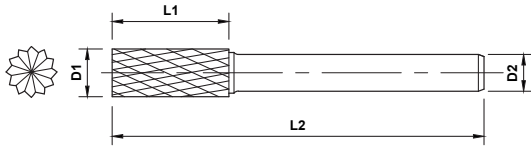

Non-Ferrous **N** Alumacuts recommended for non-ferrous materials

Cast Iron **K** Titanium **S** Stainless **M** Steel **P** Hardened **H**

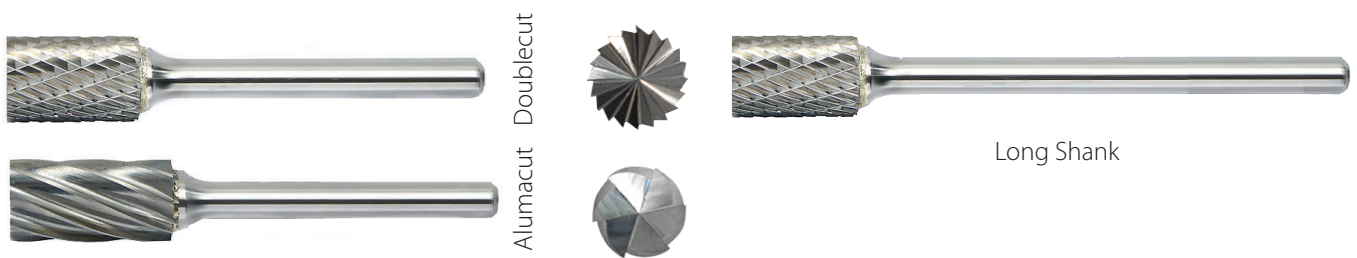

Length Key (K)

Standard Long * Solid Carbide

Quick Ship Items

	OD	LOC	SHK	OAL	Cut Type	
	D1	L1	D2	L2	Doublecut	Alumacut
*	1/8	9/16	1/8	1-1/2	SB-43DC	-
*	1/4	5/8	1/4	2	SB-1DC	SB-1FM
	3/8	3/4	1/4	2-1/2	SB-3DC	SB-3FM
		3/4	1/4	6-3/4	SB-3L6DC	SB-3L6FM
	1/2	1	1/4	2-3/4	SB-5DC	SB-5FM
		1	1/4	7	SB-5L6DC	SB-5L6FM

* Solid Carbide • *全然 碳化物

Fractional Products

具有英寸测量的产品

SC BURS - RADIUS CYLINDRICAL SHAPE

SC-球头柱体型旋转锉

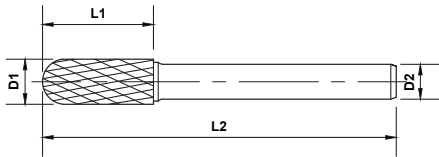

Non-Ferrous **N** Alumacuts recommended for non-ferrous materials

Cast Iron **K** Titanium **S** Stainless **M** Steel **P** Hardened **H**



Length Key (K)

Standard Long * Solid Carbide

Quick Ship Items

	OD	LOC	SHK	OAL	Cut Type	
	D1	L1	D2	L2	Doublecut	Alumacut
*	1/8	9/16	1/8	1-1/2	SC-42DC	-
*	1/4	5/8	1/4	2	SC-1DC	SC1-FM
	3/8	3/4	1/4	2-1/2	SC-3DC	SC-3FM
		3/4	1/4	6-3/4	SC-3L6DC	SC-3L6FM
	1/2	1	1/4	2-3/4	SC-5DC	SC-5FM
		1	1/4	7	SC-5L6DC	SC-5L6FM

* Solid Carbide * 全然 碳化物

Fractional Products
具有英寸测量的产品

Email: sales@mastercuttool.com
www.mastercuttool.com



SD BURS - BALL SHAPE

SD-球体型旋转锉

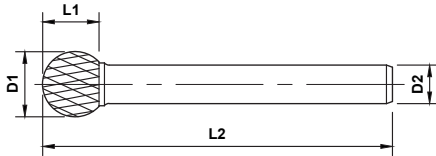

Non-Ferrous **N** Alumacuts recommended for non-ferrous materials

Cast Iron **K** Titanium **S** Stainless **M** Steel **P** Hardened **H**



Alumacut Doublecut



Long Shank

Length Key (K)

Standard Long * Solid Carbide

Quick Ship Items

	OD	LOC	SHK	OAL	Cut Type	
	D1	L1	D2	L2	Doublecut	Alumacut
*	1/8	1/8	1/8	1-1/2	SD-42DC	-
*	1/4	7/32	1/4	2	SD-1DC	SD-1FM
	3/8	5/16	1/4	2-1/8	SD-3DC	SD-3FM
		5/16	1/4	6-3/8	SD-3L6DC	SD-3L6FM
	1/2	7/16	1/4	2-1/4	SD-5DC	SD-5FM
		7/16	1/4	6-1/2	SD-5L6DC	SD-5FM

* Solid Carbide • *全然 碳化物

Fractional Products

具有英寸测量的产品

SE BURS - OVAL SHAPE

SE-橄榄型旋转锉

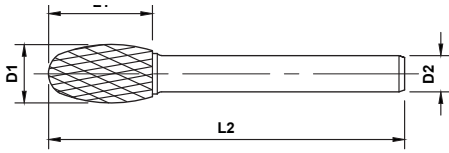

Non-Ferrous **N** Alumacuts recommended for non-ferrous materials

Cast Iron **K** Titanium **S** Stainless **M** Steel **P** Hardened **H**

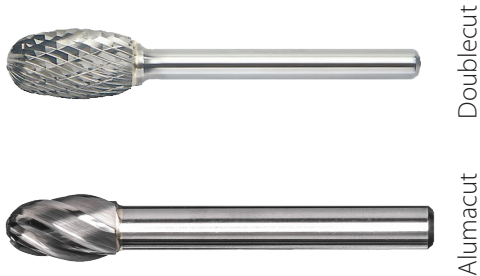

Length Key (K)

Standard Long * Solid Carbide

Quick Ship Items

	OD	LOC	SHK	OAL	Cut Type	
	D1	L1	D2	L2	Doublecut	Alumacut
*	1/8	7/32	1/8	1-1/2	SE-41DC	-
*	1/4	3/8	1/4	2	SE-1DC	SE-1FM
	3/8	5/8	1/4	2-3/8	SE-3DC	SE-3FM
		5/8	1/4	6-5/8	SE-3L6DC	SE-3L6FM
	1/2	7/8	1/4	2-5/8	SE-5DC	SE-5FM
		7/8	1/4	6-7/8	SE-5L6DC	SE-5L6FM

* Solid Carbide • *全然 碳化物

Fractional Products
具有英寸测量的产品

Email: sales@mastercuttool.com
www.mastercuttool.com



SF BURS - RADIUS TREE SHAPE

SF-圆顶树体型旋转锉

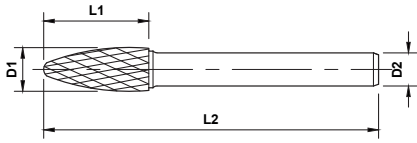

Non-Ferrous **N** Almacuts recommended for non-ferrous materials

Cast Iron **K** Titanium **S** Stainless **M** Steel **P** Hardened **H**



Length Key (K)

Standard Long * Solid Carbide

Quick Ship Items

	OD	LOC	SHK	OAL	Cut Type	
	D1	L1	D2	L2	Doublecut	Almacut
*	1/8	1/2	1/8	1-1/2	SF-42DC	-
*	1/4	5/8	1/4	2	SF-1DC	SF-1FM
	3/8	3/4	1/4	2-1/2	SF-3DC	SF-3FM
		3/4	1/4	6-3/4	SF-3L6DC	SF-3L6FM
	1/2	1	1/4	2-3/4	SF-5DC	SF-5FM
		1	1/4	7	SF-5L6DC	SF-5L6FM

* Solid Carbide • *全然 碳化物

Fractional Products
具有英寸测量的产品

SG BURS - POINTED TREE SHAPE

SG-尖顶树体型旋转锉

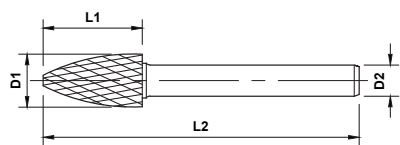

Doublecut



Long Shank

Non-Ferrous **N** Alumacuts recommended for non-ferrous materials

Cast Iron **K** Titanium **S** Stainless **M** Steel **P** Hardened **H**

Length Key (K)

Standard Long * Solid Carbide

Quick Ship Items

	OD	LOC	SHK	OAL	Cut Type
	D1	L1	D2	L2	Doublecut
*	1/8	3/8	1/8	1-1/2	SG-43DC
*	1/4	5/8	1/4	2	SG-1DC
	3/8	3/4	1/4	2-1/2	SG-3DC
		3/4	1/4	6-3/4	SG-3L6DC
	1/2	1	1/4	2-3/4	SG-5DC
		1	1/4	7	SG-5L6DC

* Solid Carbide • *全然 碳化物

SH BURS - FLAME SHAPE

SH-尖顶树体型旋转锉

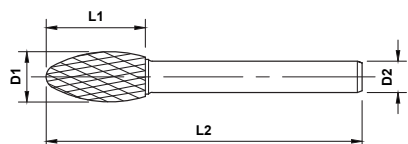

Doublecut

Non-Ferrous **N** Alumacuts recommended for non-ferrous materials

Cast Iron **K** Titanium **S** Stainless **M** Steel **P** Hardened **H**

Length Key (K)

Standard Long * Solid Carbide

Quick Ship Items

	OD	LOC	SHK	OAL	Cut Type
	D1	L1	D2	L2	Doublecut
*	1/8	1/4	1/8	1-1/2	SH-41DC
*	1/4	1/2	1/4	2	SH-1DC
	5/16	3/4	1/4	2-1/2	SH-2DC
	1/2	1-1/4	1/4	3	SH-5DC

* Solid Carbide • *全然 碳化物

SL BURS - RADIUS CONE SHAPE

SL-圆顶锥体型旋转锉

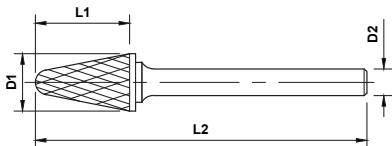

Non-Ferrous **N** Almacuts recommended for non-ferrous materials

Cast Iron **K** Titanium **S** Stainless **M** Steel **P** Hardened **H**



Length Key (K)

Standard Long * Solid Carbide

Quick Ship Items

	OD	LOC	SHK	OAL	Angle	Cut Type	
	D1	L1	D2	L2	Deg	Doublecut	Alumacut
*	1/8	3/8	1/8	1-1/2	8°	SL-41DC	-
*	1/4	5/8	1/4	2	14°	SL-1DC	SL-3FM
	3/8	1-1/16	1/4	2-13/16	14°	SL-3DC	SL-3FM
		1-1/16	1/4	7-1/16	14°	SL-3L6DC	SL-3L6FM
	1/2	1-1/8	1/4	3-1/64	14°	SL-4DC	SL-4FM
		1-1/8	1/4	7-1/8	14°	SL-4L6DC	SL-4L6FM

* Solid Carbide • *全然 碳化物

Fractional Products

具有英寸测量的产品

SM BURS - POINTED CONE SHAPE

SM-尖顶锥体型旋转锉

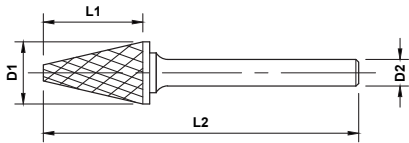

Non-Ferrous
N Alumacuts recommended for non-ferrous materials

Cast Iron **K** Titanium **S** Stainless **M** Steel **P** Hardened **H**



Doublecut



Long Shank

Length Key (K)

Standard Long * Solid Carbide

Quick Ship Items

	OD	LOC	SHK	OAL	Inclusive Angle	Cut Type	
	D1	L1	D2	L2	Deg	Doublecut	Chipbreaker
*	1/8	11/32	1/8	1-1/2	12°	SM-41DC	SM-41CB
*	1/4	1/2	1/4	2	14°	SM-1DC	SM-1CB
	3/8	5/8	1/4	2-1/2	28°	SM-4DC	SM-4CB
	1/2	7/8	1/4	2-5/8	28°	SM-5DC	SM-5CB
		7/8	1/4	6-7/8	28°	SM-5L6DC	SM-5L6CB

* Solid Carbide • *全然 碳化物

Fractional Products
具有英寸测量的产品

MASTERCUT PREMIER COATINGS

MASTERCUT 溢价 涂层

- Speed and Feed increases from 30 to 200 percent
- Tool life is increased up to 10 times
- Reduces friction, spindle torque and vibration, providing a better finish
- Isolates the tool from the part, avoids edge buildup and tool cratering
- Reduces or eliminates coolant requirements
- Repeatable, stable performance between batches

- 正确的涂层选择,使你的加工:
- 转速和进给提高30-200%
- 刀具寿命最大增加到10倍
- 降低摩擦阻力,主轴扭矩和振动
- 从而提供一个更好的加工表面
- 隔绝刀体材料和加工件,可以避免
- 卷刃和崩刃产生
- 降低和取消冷却剂的要求
- 批次加工的重复及稳定性表现出色

MASTERCUT TOOL COATING OPTIONS

• Preferred Coating Use • 可供选择的涂层

									
	Materials	PowerT	PowerC	PowerA	PowerZ	PowerNR	PowerN	PowerDLC	PowerRD
1	Aluminum, Low Silicon < 10% 铝, 低硅 < 10%				✓			✓	✓
2	Aluminum, High Silicon > 10% 铝, 高硅 > 10%		✓		✓			✓	✓
3	Copper, Copper Alloys 铜, 铜合金	✓		✓	✓			✓	
4	Ductile, Malleable Cast Iron 球墨铸铁, 可锻5.铸铁	✓	✓	✓	✓	✓	✓		
5	Carbon Steel, 1000 Series 碳钢, 1000系列	✓	✓	✓		✓	✓		
6	Alloy Steel, 4 to 9000 Series 合金钢, 4000到9000	✓	✓	✓		✓	✓		
7	Tool Steel 工具钢	✓	✓	✓		✓	✓		
8	SS Steel, 300 Series SS钢, 300系列	✓	✓	✓	✓	✓	✓		
9	SS Steel, 400 Series SS钢, 400系列	✓	✓	✓	✓	✓	✓		
10	SS PH Series SS PH系列	✓	✓	✓	✓	✓	✓		
11	Titanium, Titanium Alloys 钛, 钛合金	✓	✓	✓	✓	✓	✓		
12	Nickel, Nickel Alloys, Cobalt 镍, 镍合金, 钴	✓		✓		✓	✓		
13	Wood, Paper 木材, 纸			✓	✓			✓	
14	Composites, Plastics 复合材料, 塑料	✓		✓	✓		✓	✓	✓
15	Graphite 石墨							✓	✓
16	Fiberglass 玻璃纤维		✓	✓	✓			✓	✓

COATINGS

MASTERCUT TOOL COATING OPTIONS

Our Available Coatings



PowerT (Titanium Nitride, TiN) (append -2)*

Color: Gold
Vickers Hardness: Approximately 2,300 Vickers
General purpose, entry level over uncoated carbide



PowerC (Titanium Carbon Nitride, TiCN) (append -3)*

Color: Ranges from slight violet to brown-gray
Vickers Hardness: Approximately 3,000 Vickers
Used on ferrous, non-ferrous and non-magnetic stainless steel
Good abrasion resistance, low heat resistance, for applications requiring low RPMs and high thrust



PowerA (Aluminum Titanium Nitride, AlTiN) (append -1)*

Color: Dark Gray
Vickers Hardness: Approximately 3,600 Vickers
Nickel Alloys, Stainless Steel, Hardened Steels, Tool Steels, Cast Iron
An excellent broad spectrum grade. May be run in dry or minimum quantity lubrication applications, where heat can be a problem. Also handles light chip loads very well



PowerZ (Zirconium Nitride, ZrN) (append -4)*

Color: Dull Gold
Vickers Hardness: Approximately 2,800 Vickers
Outstanding on aluminum, including high silica aluminum. Can also be used on cast iron, stainless steels, titanium

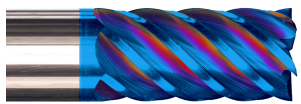

PowerN (nACo) nano-composite (nc-AlTiN)/(a-Si³N⁴) (append -5)*

Color: Varying hues of blue and red
Vickers Hardness: approximately 4,500 Vickers
Outstanding performance in superalloys, hard material machining, and high heat applications.



PowerNR (nACRo) nano-composite (nc-AlCrN/a-Si³N⁴)(append -8)*

Color: gray
Vickers Hardness: 4,000 Vickers
Outstanding in high heat applications, better resistance to shock and chipping than nACo, for tough, aggressive cutting applications.



PowerDLC (Diamond Like Carbon)(append -6)*

Color: variable gray to black
Vickers Hardness: approximately 4,000 Vickers
Non-ferrous metals, high silicone aluminum, copper, plastic, graphite, fiberglass or reinforced plastics
Can be applied to any carbide substrate



PowerRD (Real Diamond)(append -7)*

Color: variable gray to black
Vickers Hardness: approximately 8,000 Vickers
Non-ferrous, metals, aluminum, graphite, green ceramics, and composites
Requires 6% cobalt carbide for application

* **append -#** indicates that this coating is applied to uncoated tool part number

Mastercut 刀具涂层选项

可以提供的涂层

PowerT (氮化钛, 锡) (追加-2) *

颜色: 金色
维氏硬度: 约2,300V
一般用途刀具涂层

PowerC (碳氮化钛, 的TiCN) (追加-3) *

颜色: 范围从轻微到紫褐色, 灰色
维氏硬度: 约3000维氏
用于对黑色, 非铁和非磁性不锈钢
良好的耐磨性, 耐热性低, 对于需要低RPM和高推力的应用

PowerA (铝氮化钛, 的AlTiN) (追加-1) *

颜色: 深灰色
维氏硬度: 约3600维氏
镍合金, 不锈钢, 淬火钢, 工具钢, 铸铁
一个优秀的广谱档次。可在干燥或最小量润滑的应用, 其中的热量可以是一个问题地运行。还可以处理轻负载的芯片非常好

PowerZ (氮化锆, 氮化锆) (追加-4) *

颜色: 深灰色
维氏硬度: 约3600维氏
镍合金, 不锈钢, 淬火钢, 工具钢, 铸铁
一个优秀的广谱档次。可在干燥或最小量润滑的应用, 其中的热量可以是一个问题地运行。还可以处理轻负载的芯片非常好

PowerN (nACo) 纳米复合材料 (NC-的AlTiN) / (A-Si³N⁴) (追加-5) *

颜色: 各种色调的蓝色和红色
维氏硬度: 约4500维氏
它最适合用于高温合金、硬质材料加工和高温应用。

PowerNR (nACRo) 纳米复合材料 (NC-的AlCrN/ A-Si³N⁴) (附加-8) *

颜色: 灰
维氏硬度: 维氏4000
杰出的高温应用, 更好的耐冲击和切削比NACO, 为坚韧, 进取的切割应用。

PowerDLC (类金刚石) (附加-6) *

颜色: 变灰色至黑色
维氏硬度: 约4000
非铁金属, 高硅的铝, 铜, 塑料, 石墨, 玻璃纤维或增强塑料

PowerRD (金刚石涂层) (附加-7) *

颜色: 灰色至黑色
维氏硬度: 约8000V
有色金属, 铁金属, 铝, 石墨, 烧结前陶瓷
需要6%的钴硬质合金的应用

*附加 - # 表明该涂层被施加到未涂覆工具部件编号

TECHNICAL INFORMATION

技術情報

- **MAP**
- **CNC 1st**
- **ISO**
- **Coatings**
- **Trouble Shooting Guide**
- **Speeds and Feeds**

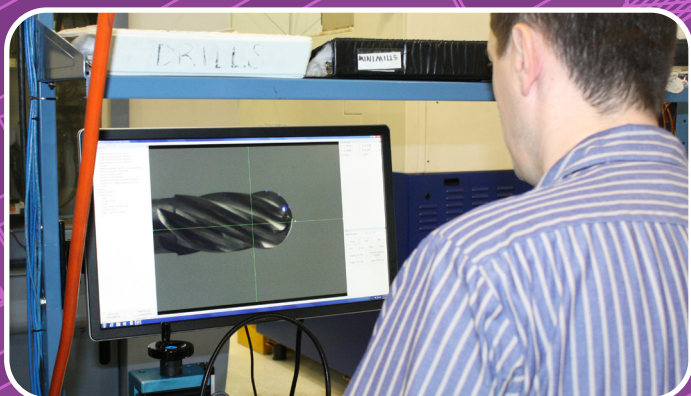
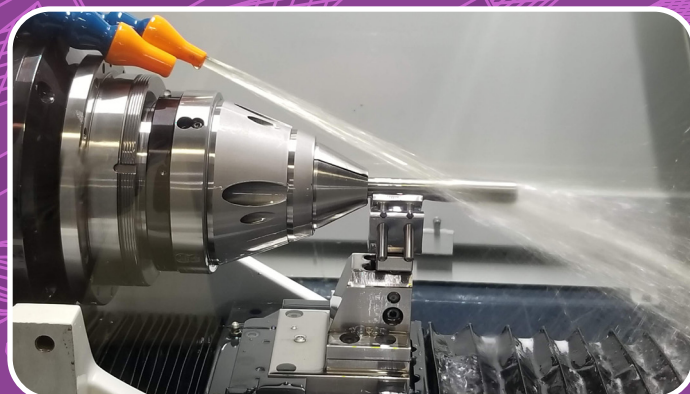
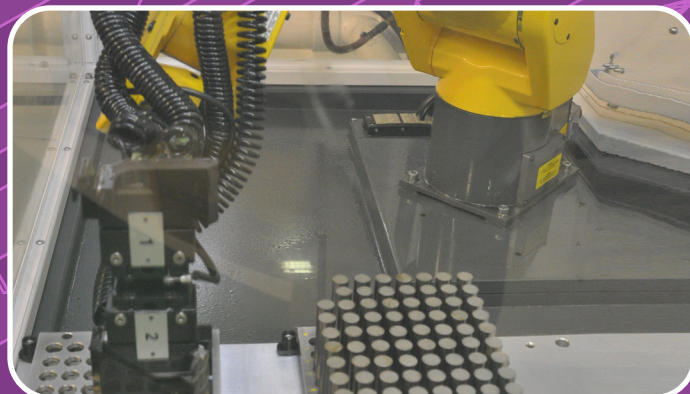
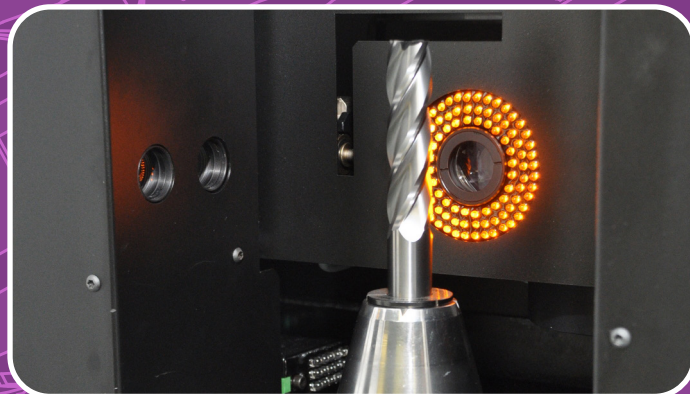



Quality Processes

YOUR PREMIER SOURCE FOR THE HIGHEST QUALITY CUTTING TOOLS FOR MORE THAN A QUARTER CENTURY!

From 1985 to the present, the values and ideals of Mastercut Tool Corp. remain steady. We will work relentlessly to continuously improve and provide you with excellence. We are known worldwide for many unique high performance tools engineered in our Florida facilities. Our AxMill, V4, V5, and F45 are just a few products that make Mastercut Tool Corp. your choice for increasing production and reducing costs.

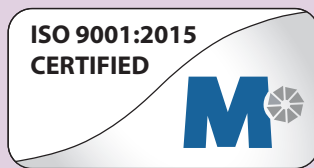

ISO 9001:2015

In 2003, Mastercut Tool Corp. successfully achieved registration under ISO 9001:2000 and has maintained our quality system to our current ISO 9001:2015 certification. We maintain these strict standards and Lean/Six Sigma practices to further guarantee that every tool you buy from Mastercut Tool Corp. is of the highest quality.

The "MAP" to Your Success!

Our continuous improvement has led us to a process that gives you unmatched, consistent quality. That process is our unique MAP Technology! Mastercut Automated Production is our exclusive method of standardization and quality repeatability. The MAP combines technology, skill, and rigid processes to provide you with the most precise products that money can buy, batch to batch and year to year.

Our MAP...your map to success!



TECHNICAL INFORMATION



CNC 1st Team

Customers' Needs Come First! This is what truly matters to us. To ensure you the fastest possible service, we have assembled simulation, engineering, production scheduling, customer service, and inventory personnel into one unit. They collaborate on any and all special requests from you, the moment your request is received. They are dedicated and qualified to assist you with solutions, fast!

Mastercut's Superior Carbide Blend – A-Gr-SiV (Active Grain Sized Volume)

Our superior tungsten carbide gives you the ability to be aggressive when you need to be. Growth inhibitors in our submicron carbide blanks maintain the most consistent grain size available, giving you superior hardness AND toughness.

SUCCESS

At Mastercut Tool, we take great pride in our high quality control standards and in the accomplishments of your customers using our superior quality tools. Therefore, our bottom line is:

Your customers' success with our products is the measure of our success!



质量流程

我们作为顶级刀具的优质供应商三十年有余！

从 1985 年至今，刀具公司坚定不移地秉承其价值观和理念。孜孜不倦，持续改进，竭诚为您提供优质产品和服务。凭借位于美国佛罗里达州生产基地精工打造众多独一无二的高性能产品，享誉全球。我们的Axmill,V4,V5和F45是众多优质产品的代表，是客户增加生产效率降低成本的最佳选择。



ISO 9001:2015 认证

2003年，MasterCut通过了ISO 9001：2000认证，并始终坚持质量体系，现已通过ISO 9001：2015认证。我们遵守这些严格的质量标准，以进一步确保您从Mastercut Tool购买的每个工具都具有最高质量。

MAP” 技术，成功之路！

我们持续做出改进，形成打造出无与伦比、始终如一的产品品质的生产流程。这项流程便是我们独一无二的 MAP 技术！迈斯卡自动化生产使我们独有的标准化和质量可重复性生产方法。MAP 技术结合技术、技能和严谨的生产流程，为您提供一批批价格实惠、极致精密的产品，年复一年、经久不息。

我们的 MAP 技术为您铺设成功之路！



客户需求第一位原则

客户需求至上！这是我们真正的重中之重。为确保尽可能为您提供极致快捷的服务，我们将模拟、设计、生产调度和库存管理人员集中到一个工作间，他们可在此针对您的任何特殊要求开展合作，即时响应您的要求。他们爱岗敬业、资质过硬，能助力您快速找出解决方案！

迈斯卡的超级硬质合金材质 - A-Gr-SiV

迈斯卡的超级硬质合金材质 - 拥有均匀亚微米晶粒，完美的硬度和韧性的结合，保证我们的刀具可以面对各种挑战时游刃有余。

成功

迈斯卡刀具公司拥有严格的质量控制标准，您的顾客使用我们的优质刀具取得了一系列卓越的成就，我们对此深感自豪。因此，我们的底线是：

您的顾客使用我们的产品所取得的成功 - 就是我们取得成功的衡量标准

TECHNICAL INFORMATION FOR AXMILLS

对于 AxMills 的技术信息

Suggested Axial/Radial Loads - 轴/径向载荷推荐值

• Work Material • 加工工件材质	Type of Cut	Axial DOC	Radial DOC	Flutes
• Aluminum Alloys 2024, 6061, 7075 • 铝合金2024 6061 7075	1	1xD	1xD	2
	2	1xD	.75xD	3
	3	1.5xD	.01xD	3
• High Silicon Aluminum A380, A390 • 高硅铝合金A380, A390	1	.5xD	1xD	3
	2	1xD	.5xD	3
	3	1.5xD	.01xD	3
• Magnesium Alloys • 镁合金	1	1xD	1xD	2
	2	1xD	.75xD	3
	3	1.5xD	.01xD	3
• Copper Alloys, Brass, Bronze • 铜合金, 黄铜, 青铜	1	.75xD	1xD	2
	2	1xD	.75xD	3
	3	1.5xD	.01xD	3
• Composites Plastics and Fiberglass • 合成材料塑料和玻璃纤维	1	1xD	1xD	3
	2	1xD	.75xD	3
	3	1.5xD	.01xD	3

Type of Cut		
1	Slotting	插开槽
2	Roughing	粗加工
3	Finishing	整理

TECHNICAL INFORMATION

TECHNICAL INFORMATION FOR HP DRILLS

高性能飓风钻的技术信息

进给速度 (mm/转)

ø mm	Feed Rate Code (mm per Revolution)								
	1	2	3	4	5	6	7	8	9
3	0.025	0.381	0.051	0.076	0.076	0.102	0.127	0.152	0.152
4	0.051	0.051	0.076	0.076	0.102	0.127	0.152	0.203	0.203
5	0.051	0.051	0.076	0.076	0.102	0.127	0.152	0.203	0.254
6	0.051	0.076	0.076	0.102	0.127	0.152	0.203	0.254	0.318
8	0.076	0.076	0.102	0.102	0.152	0.203	0.254	0.318	0.318
10	0.076	0.102	0.102	0.152	0.203	0.254	0.318	0.406	0.406
12	0.102	0.102	0.127	0.178	0.203	0.254	0.318	0.406	0.508
16	0.102	0.127	0.178	0.203	0.254	0.318	0.406	0.508	0.635
20	0.127	0.152	0.203	0.254	0.318	0.406	0.508	0.635	0.635

MASTERCUT TROUBLESHOOTING GUIDES

刀具问题解决指南

Solid Carbide Endmills		
Challenge	Cause	Corrective Action
Chattering	Incorrect Feed Rate	Reduce feed rate 10%
	Incorrect Speed	Check recommendations, adjust accordingly
	Low Tool Holder Rigidity	Replace tool holder with more rigid tool holder
	Low Machine Tool Spindle Rigidity	Utilize machine with larger spindle
	Relief Angle Too Steep	Switch to tool with less relief or regrind tool to reduce angle
	Low Work Piece Rigidity	Tighten or improve work piece holding method
	Depth of Cut	Reduce depth of cut
	Incorrect Tool Cut Length	Use shorter flute length and/or place tool shank deeper in tool holder
	Bad Collet	Replace collet
	Tool Too Sharp	Reduce feed rate 10% for initial cut to break in tool
Breakage	Incorrect Feed Rate	Reduce feed rate
	Incorrect Depth of Cut	Reduce depth of cut
	Incorrect Tool Cut Length	Use shorter flute length - Place tool shank deeper in tool holder
	Incorrect Tool Overall Length	Use shorter tool or place tool shank deeper in tool holder
	Tool Wear	Replace tool or sharpen tool at earlier stage
	Chip Impaction	Increase coolant flow
Chipping	Incorrect Feed Rate	Reduce feed rate
	Improper Tool Break In	Reduce feed rate 10% for initial cut to break in tool
	Incorrect Feed Direction	Change cut path to climb milling
	Chatter	See recommendations for correcting chatter
	Low Tool Holder Rigidity	Replace tool holder with higher rigidity tool holder
	Low Machine Tool Spindle Rigidity	Utilize machine with larger spindle
	Low Work Piece Rigidity	Tighten or improve work piece holding method
	Tool Too Sharp	Reduce feed rate 10% for initial cut to break in tool
	Loose Tool Holder	Clean and tighten tool holder
	Loose End Mill	Tighten tool holder
	Incorrect Speed	Check recommendations and adjust accordingly
Lack of Hone	Hone cutting edge	
Wear	Incorrect Speed	Check recommendations and adjust accordingly
	Incorrect Feed Rate	Reduce or increase feed rate
	Incorrect Feed Direction	Change cut path to climb milling
	Hard Material	Use tool designed for hard material - Use coated tools
	Chip Impaction	Increase coolant volume - Increase coolant pressure
	Poor Coolant Condition	Replace coolant or correct mix ratio
	Short Tool Life	Use tool designed for work piece material - Use coated tools
	Incorrect Tool Geometry	Utilize tool recommended for work piece material
Chip Impaction	Incorrect Feed Rate	Reduce feed rate
	Incorrect Speed	Check recommendations and adjust accordingly
	Incorrect Tool Geometry	Utilize tool recommended for work piece material
	Insufficient Coolant	Increase coolant volume - Increase coolant pressure

MASTERCUT TROUBLESHOOTING GUIDES

刀具问题解决指南

Solid Carbide Endmills		
Challenge	Cause	Corrective Action
Poor Surface Finish	Incorrect Feed Rate	Reduce feed rate
	Incorrect Speed	Check recommendations and adjust accordingly
	Tool Wear	Replace tool or sharpen tool at earlier stage
	Incorrect Depth of Cut	Reduce depth of cut
	Chip Impaction	Increase coolant volume - Increase coolant pressure
	End Cut Smearing	Grind tool with wiper flat
	Incorrect Tool Geometry	Utilize tool recommended for work piece material
Burring	Tool Wear	Replace tool or sharpen tool at earlier stage
	Incorrect Feed Direction	Change cut path to climb milling
	Incorrect Speed	Check recommendations and adjust accordingly
	Incorrect Feed Rate	Reduce feed rate
	Incorrect Depth of Cut	Reduce depth of cut
	Incorrect Tool Geometry	Utilize tool recommended for work piece material
Dimensional Inaccuracy	Tool Deflection	Reduce tool length of cut - Place tool deeper in tool holder
	Incorrect Tool Geometry	Utilize tool recommended for work piece material
	Low Tool Holder Rigidity	Replace tool holder with more rigid tool holder
	Low Machine Tool Spindle Rigidity	Utilize machine with larger spindle - Tighten tool holder
	Low Work Piece Rigidity	Tighten or improve work piece holding method
	Bad Collet	Replace collet
	Machine Tool/Work Piece Set Up	Check for proper angular set up

Solid Carbide Drills		
Challenge	Cause	Corrective Action
Drill Point Chipping	Incorrect Feed Rate	Lower feed rate
	Incorrect Speed Rate	Check speed recommendations, adjust accordingly
	Incorrect Tool Cut Length	Use shorter tool - place tool shank deeper in tool holder
	Low Work Piece Rigidity	Tighten or improve work piece holding method
	Loose Tool	Tighten or replace tool holding method
	Poor Coolant Conditions	Replace coolant or correct mix ratio
Chisel/Point Center Breakage	Incorrect Initial Feed Rate	Lower initial feed rate 30%
	Poor Work Piece Surface Condition	Grind or clean work piece surface
	Drill Point Off Center	Re-point drill, check set up in tool holder
	Insufficient Drill (web) Thinning	Re-point and thin drill point
Breakage/ Chipping at Outer Cutting Edge	Incorrect Feed Rate	Lower feed rate
	Incorrect Speed Rate	Check speed recommendations, adjust accordingly
	Low Work Piece Rigidity	Tighten or improve work piece holding method
	Low Tool Holding Strength	Tighten tool holder or use end mill holder
	Poor Tool Set Up - Concentricity	Minimize runout to less than .001"
	Poor Coolant Conditions	Replace coolant or correct mix ratio
	Incorrect Tool Cut Length	Use shorter tool - place tool shank deeper in tool holder
Tool Wear Life	Incorrect Speed Rate	Check speed recommendations, adjust accordingly
	Poor Coolant Conditions	Replace coolant or correct mix ratio
	Improper Drill Point	Re-point drill or use recommended drill point for material
	Abrasive/Tough Work Piece Material	Use coated tool (Check recommendations for coating)

MASTERCUT TROUBLESHOOTING GUIDES

刀具问题解决指南

Solid Carbide Drills		
Challenge	Cause	Corrective Action
Tool Breakage	Inconsistent Feed Rate	Maintain constant feed rate
	Incorrect Feed Rate	Lower feed rate
	Poor Tool Set Up - Concentricity	Minimize runout to less than .001"
	Low Tool Holding Strength	Tighten tool holder or use end mill holder
	Incorrect Tool	Check recommendations for proper drill and drill point
	Poor Coolant Conditions	Replace coolant or correct mix ratio
	Low Work Piece Rigidity	Tighten or improve work piece holding method
Outside Margin Damage / Wear	Poor Tool Set Up - Concentricity	Minimize runout to less than .001"
	Incorrect Tool Selection	Use recommended drill/drill point for work piece material
	Poor Coolant Conditions	Replace coolant or correct mix ratio
	Insufficient Coolant	Increase coolant volume - Increase coolant pressure
	Chip Packing	Increase coolant volume - Increase coolant pressure
Outside Margin Damage / Wear (cont.)	Low Work Piece Rigidity	Tighten or improve work piece holding method
	Loose Tool	Tighten or replace tool holding method
	Incorrect Feed Rate	Lower feed rate
	Incorrect Speed Rate	Check speed recommendations adjust accordingly
Chip Impaction	Incorrect Speed Rate	Typically increase speed, check speed recommendations
	Incorrect Feed Rate	Typically increase feed recommendations
	Poor Coolant Conditions	Replace coolant or correct mix ratio
	Insufficient Coolant	Increase coolant volume - Increase coolant pressure
	Incorrect Tool	Check recommendations for proper drill and drill point
Long/Stringy Chips	Incorrect Feed Rate	Typically increase feed, check feed recommendations
	Incorrect Point Angle	Regrind Point to recommended angle, Replace drill
	Edge Sharpness	Hone cutting edge, use pre-honed drill
	Inconsistent Feed Rate	Maintain constant feed rate - Peck Drill to change feed rate
Poor Surface Finish	Incorrect Speed Rate	Typically increase speed, check speed recommendations
	Incorrect Feed Rate	Lower feed rate
	Poor Coolant Conditions	Replace coolant or correct mix ratio
	Tool Wear	Regrind or Replace drill
Hole Accuracy	Edge Sharpness	Hone cutting edge, use pre-honed drill
	Incorrect Tool	Check recommendations for proper drill and drill point
	Edge Sharpness	Hone cutting edge, use pre-honed drill
	Incorrect Tool Cut Length	Use shorter tool - place tool shank deeper in tool holder
	Tool Size Accuracy	Replace tool
Tool Deflection	Poor Work Piece Surface Condition	Grind or clean work piece surface
	Incorrect Tool Cut Length	Use shorter tool - place tool shank deeper in tool holder
	Uneven Drill Point	Regrind drill point
	Incorrect Point Angle	Regrind Point to recommended angle, Replace drill
	Uneven Work Surface	Use self centering drill point or spot drill
Vibration/Noise	Edge Sharpness	Hone cutting edge, use pre-honed drill
	Incorrect Tool Cut Length	Use shorter tool - place tool shank deeper in tool holder
	Incorrect Point Angle	Regrind Point to recommended angle, Replace drill
	Inconsistent Feed Rate	Maintain constant feed rate - Peck Drill to change feed rate
	Incorrect Speed Rate	Check speed recommendations adjust accordingly
	Low Tool Holding Strength	Tighten tool holder or use end mill holder

TROUBLESHOOTING GUIDE AND SOLUTION KEYS

可能发生的问题和解决方案

Carbide Burs - Possible Causes and Solutions																						
Challenge 问题现象	Excessive Force	Heat From Rubbing Shank	Dull Flutes	Seized In/Against Workpiece	Tool Dropped	Poor Location in Collet	Worn Handpiece Bearings	Bent Shank	Poor Working Stability	Use Coarser Geometry	Use Finer Geometry	Use Double Cut or Chip Breaker Geometry	Soft Material - Lighten Feed	Increase RPMs	Decrease RPMs	Avoid Diamond Cut	Use Anti-stick compound	Faster Feed Rate	Slower Feed	Abrasive Material	Poor Set-Up	Failure To Support / Engage Prior to RPM
Language Keys	1.	2.	3.	4.	5.	6.	7.	8.	9.	10.	11.	12.	13.	14.	15.	16.	17.	18.	19.	20.	21.	22.
A. Braze Failure	X	X	X	X	X																	
B. Poor Hand Control						X	X	X	X		X	X									X	
C. Chipping				X	X				X					X								X
D. Carbide Fracture				X	X				X													X
E. Plugging										X			X				X					
F. Handpiece Vibration														X	X			X	X		X	
G. Poor Workpiece Finish						X	X	X	X		X			X	X			X			X	
H. Poor Tool Life		X	X			X	X	X	X					X	X	X		X	X	X	X	
J. Lack of Available Handpiece RPMs												X		X								
K. Work Hardening of Workpiece	X		X							X		X			X				X			
L. Bent Shanks of Long Series Burs																					X	X

TECHNICAL INFORMATION

A.	脱焊
B.	手动工具控制不良
C.	刀具崩刃
D.	断裂
E.	反向退刀
F.	手动刀具振动
G.	工件表面光洁度差
H.	刀具寿命短
J.	手动工具转速不足
K.	工件加工硬化
L.	刀柄严重弯曲

1.	用力过度;
2.	刀柄摩擦生热
3.	刀刃较钝;
4.	刀具卡入或碰上工件
5.	刀具掉落;
6.	夹持位置不当
7.	手动工具轴承磨损;
8.	刀柄弯曲;
9.	操作稳定性差;
10.	使用粗牙刃形
11.	使用细牙刃形
12.	使用双切刃或带碎屑槽刃

13.	软材料 - 轻柔进给;
14.	增加转数;
15.	减少转数
16.	避免金刚石刃型
17.	使用抗粘连涂层
18.	增加进给速度
19.	降低进给速度
20.	磨蚀材料
21.	刀具安装/设置不当
22.	刀具夹持不当

TECHNICAL INFORMATION MATERIALS GROUPINGS

材料分组技术信息

Material Group	Material Type	Hardness	BS	EN & Other Standards
Steel				
1.1	Magnetic soft steel	< 120 B	230M07, 050A12	EN1, EN2 Leadloy
1.2	Structural, case carburising	< 200 B	060A35, 080M40, 4360-50B	EM3A, 4,6,7,8, EN207, S62
1.3	Plain carbon steel	< 250 B	080M46, 080A62	EN9, 10, 43, S70
1.4	Alloy Steel	< 250 B	708M40/42, 817M40, 534A99, BM2, BT42	"EN16,17, 19(R,S) EN31, S2-10-1-8 (Soft)"
1.5	Alloy steel, hardened/tempered steel	350	B01, BM2, BT42, 826M40, 830M32	"EN24, 25,26(T,U,V) S95, S97, S98 (annealed)"
1.6	Alloy steel, hardened/tempered steel	> 350 B	801, 826M40, 830M31	EN25, 26, 27,(W,X,Z) S97, S98, (H&T)
1.7	Alloy steel, hardened	49-55 C	B01, BD3, BH13	
1.8	Alloy steel, hardened	55-60 C	BM2, BH13	
1.9	Alloy steel, hardened	>60C		
Stainless Steel				
2.1	Free Machining Stainless	< 250 B	303 S21 416 S37	EN56, EN60
2.2	Austenetic	< 250 B	304 S15, 321 S17 316 S, 320 S12	EN80, EN58 + EN8J, 316
2.3	Ferritic + Austenetic, Martensitic	< 300 B	317 S16, 316 S16	EN58 b,e,t,j, Duplex alloys
2.4	Precipitation Hardened	< 300 B		
Cast Iron				
3.1	Lamellar graphite	< 150	grade 150, grade 400	Cast iron Soft
3.2	Lamellar graphite	>150<300	grade 200, grade 400	Cast iron Hard
3.3	Nodular graphite, malleable cast iron	< 200	420/12, P440/7 700/2, 30g/72	S.G. iron Mehanite Black & White Heart
3.4	Nodular graphite, malleable cast iron	>200<300	420/12, P440/7 700/2, 30g/72	S.G. iron Mehanite Black & White Heart
Titanium				
4.1	Unalloyed	< 200	TA1-9	Ti 99.0
4.2	Alloyed	< 270	TA10-14, TA17, TA28	Ti 2AL
4.3	Alloyed	>270<350	TA10-13, TA28	Ti AL
Nickel				
5.1	Unalloyed	< 150	NA 11, NA 12	Nickel 200, Nickel 270
5.2	Alloyed	< 270	HR203 3027-76	"Nimonic 75, Hastelloy C Monel 400, Inconel 600 Haynes Alloys 263"
5.3	Alloyed	>270<350	HR8 HR401, 601	Inconel 718, Waspalloy, Nimonic 80, Rene 41
Copper				
6.1	Copper	< 100	C101	Commercially pure
6.2	β Brass, Bronze	< 200	CZ120, CZ109, PB104	2.1030, 2.1080
6.3	γ-Brass	< 200	CZ108, CZ106	
6.4	High Strength Bronze	< 470	AB1 type	Ampco 18, Ampco 26
Aluminum, Magnesium				
7.1	Al,Mg, unalloyed	< 100	LMO, 1B, (1050A)	Magnesium Extruded Aluminium
7.2	Al alloyed, Si<0.5%	< 150	LM5, 10, 12, N4 (5251)	Low Silicon wrought & cast Aluminium
7.3	Al alloyed, Si>0.5%<10%	< 120	"LM2, 4, 16, 21, 22, 24, 25, 26,27, L109"	Silicon Alluminium
7.4	Al alloyed, Si>10%	< 120	LM6, 12, 13, 20, 28, 29, 30	Higi Silicon Alluminium
Synthetic Materials				
8.1	Thermoplastics	n/a	Polystyrene, Nylon, PVC Cellulose Acetate & Nitrate	Nylon, Hostalen Makrolon
8.2	Thermosetting plastics	n/a	Ebonite, Tufnol, Bakelite	Bakelite, Pertinax
8.3	Reinforced plastic materials	n/a	Kevlar, Printed circuit board	CFK, GFK, AFK
Hard Materials				
9.1	Cermets (Metal-ceramics)	< 550		

TECHNICAL INFORMATION FOR ENDMILLS













端铣刀的技术信息

Suggested Endmill Starting Feed Per Tooth											
Cutting Diameter	0.4-1 mm	1-2mm	3mm	4mm	5mm	6mm	7-8mm	9-10mm	11-15mm	16-20mm	25mm
Material Group	vc m/min										
1.1	0.010	0.014	0.017	0.021	0.025	0.030	0.045	0.055	0.070	0.090	0.130
1.2	0.010	0.014	0.017	0.021	0.025	0.030	0.045	0.055	0.070	0.090	0.130
1.3	0.010	0.014	0.017	0.021	0.025	0.030	0.045	0.055	0.070	0.090	0.130
1.4	0.010	0.014	0.017	0.021	0.025	0.030	0.045	0.055	0.070	0.090	0.130
1.5	0.008	0.010	0.013	0.016	0.018	0.022	0.030	0.038	0.052	0.060	0.100
1.6	0.008	0.010	0.013	0.016	0.018	0.022	0.030	0.038	0.052	0.060	0.100
1.7	0.008	0.010	0.013	0.016	0.018	0.022	0.030	0.038	0.052	0.060	0.100
1.8	0.008	0.010	0.013	0.016	0.018	0.022	0.030	0.038	0.052	0.060	0.100
1.9											
2.1	0.008	0.010	0.013	0.016	0.018	0.022	0.030	0.038	0.052	0.075	0.100
2.2	0.008	0.010	0.013	0.016	0.018	0.022	0.030	0.038	0.052	0.075	0.100
2.3	0.008	0.010	0.013	0.016	0.018	0.022	0.030	0.038	0.052	0.075	0.100
2.4											
3.1	0.012	0.018	0.022	0.027	0.035	0.045	0.060	0.075	0.095	0.130	0.150
3.2	0.012	0.018	0.022	0.027	0.035	0.045	0.060	0.075	0.095	0.130	0.150
3.3	0.010	0.014	0.017	0.021	0.025	0.030	0.045	0.055	0.070	0.090	0.130
3.4	0.010	0.014	0.017	0.021	0.025	0.030	0.045	0.055	0.070	0.090	0.130
4.1	0.010	0.014	0.017	0.021	0.025	0.030	0.045	0.055	0.070	0.090	0.130
4.2	0.010	0.014	0.017	0.021	0.025	0.030	0.045	0.055	0.070	0.090	0.130
4.3	0.008	0.010	0.013	0.016	0.018	0.022	0.030	0.038	0.052	0.075	0.100
5.1	0.008	0.010	0.013	0.016	0.018	0.022	0.030	0.038	0.052	0.075	0.100
5.2	0.008	0.010	0.013	0.016	0.018	0.022	0.030	0.038	0.052	0.075	0.100
5.3	0.008	0.010	0.013	0.016	0.018	0.022	0.030	0.038	0.052	0.075	0.100
6.1	0.012	0.018	0.022	0.027	0.035	0.045	0.060	0.075	0.095	0.130	0.150
6.2	0.012	0.018	0.022	0.027	0.035	0.045	0.060	0.075	0.095	0.130	0.150
6.3	0.012	0.018	0.022	0.027	0.035	0.045	0.060	0.075	0.095	0.130	0.150
6.4	0.008	0.010	0.013	0.016	0.018	0.022	0.030	0.038	0.052	0.075	0.100
7.1	0.012	0.018	0.022	0.027	0.035	0.045	0.060	0.075	0.095	0.130	0.150
7.2	0.012	0.018	0.022	0.027	0.035	0.045	0.060	0.075	0.950	0.130	0.150
7.3	0.012	0.018	0.022	0.027	0.035	0.045	0.060	0.075	0.095	0.130	0.150
7.4	0.012	0.018	0.022	0.027	0.035	0.045	0.060	0.075	0.095	0.130	0.150
8.1	0.012	0.018	0.022	0.027	0.035	0.045	0.060	0.075	0.095	0.130	0.150
8.02	0.012	0.018	0.022	0.027	0.035	0.045	0.060	0.075	0.095	0.130	0.150
8.3	0.012	0.018	0.022	0.027	0.035	0.045	0.060	0.075	0.095	0.130	0.150
9.1	0.010	0.014	0.017	0.021	0.025	0.030	0.045	0.055	0.070	0.090	0.130

- Recommendations based on axial loads of $\leq 1X$ s the cutter diameter for profiling and $.5X$ s the diameter for slotting. Starting recommendations only.
- 推荐值基于1)(对于成型加工)轴向负荷 $\leq 1X$ 的刀具直径的 和 2)(对于开槽加工) $\leq 0.5 X$ 刀具直径建议分析。只是初始值建议













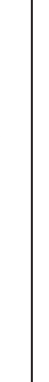

TECHNICAL INFORMATION FOR ENDMILLS

端铣刀的技术信息

Endmills	2 FL Standard Endmill	3 FL Standard Endmill	4 FL Standard Endmill	2 FL Standard Endmill	3 FL Standard Endmill	4 FL Standard Endmill	2 FL Long Endmill	3 FL Long Endmill	4 FL Long Endmill	2 FL Long Endmill	3 FL Long Endmill	4 FL Long Endmill
												
Series	Uncoated	Uncoated	Uncoated	PowerA	PowerA	PowerA	Uncoated	Uncoated	Uncoated	PowerA	PowerA	PowerA
	300-0,-1, 301-0,-1, 302-0,-1, 303-0,-1, 309-0,-2	300-4,-5, 301-4,-5, 302-4,-5, 303-4,-5, 310-0,-2	300-2,-3, 301-2,-3, 302-2,-3, 303-2,-3, 310-0,-2	300-0,-1, 301-0,-1, 302-0,-1, 303-0,-1, 309-0,-2	300-4,-5, 301-4,-5, 302-4,-5, 303-4,-5, 310-0,-2	300-2,-3, 301-2,-3, 302-2,-3, 303-2,-3, 310-0,-2	304-0,-2,-4,5, -6,-7	305-0,-2,-4,5, -6,-7	306-0,-2,-4,5, -6,-7	304-0,-2,-4,5, -6,-7	305-0,-2,-4,5, -6,-7	306-0,-2,-4,5, -6,-7
Material Group	vc m/min											
1.1	79-122	79-122	79-122	159-244	159-244	159-241	49-71	49-71	49-71	100-138	100-141	100-141
1.2	79-122	79-122	79-122	159-244	159-244	159-241	49-71	49-71	49-71	100-138	100-141	100-141
1.3	61-80	61-80	61-80	121-161	120-161	120-161	35-51	35-51	35-51	70-101	70-101	70-101
1.4	61-80	61-80	61-80	120-161	120-161	120-161	35-51	35-51	35-51	70-101	70-101	70-101
1.5	40-61	40-61	40-61	120-161	120-161	79-161	25-36	25-36	25-36	50-71	50-71	50-71
1.6	20-40	20-40	20-40	41-83	41-83	40-80	16-20	16-20	16-20	31-46	31-46	31-46
1.7				41-83	41-83	40-80				31-46	31-46	31-46
1.8				41-83	41-83	40-80				31-46	31-46	31-46
1.9												
2.1	40-80	40-80	40-80	79-161	79-161	79-161	25-49	25-49	25-49	49-98	49-98	49-98
2.2	31-49	31-49	31-49	61-101	61-101	61-101	20-31	20-31	20-31	40-61	40-61	40-61
2.3	25-40	25-40	25-40	49-80	49-80	49-80	16-25	16-25	16-25	31-49	31-49	31-49
2.4	22-37	22-37	22-37	46-68	46-68	46-68				25-43	25-43	25-43
3.1	49-80	49-80	49-80	100-153	100-153	100-153	35-61	35-61	35-61	70-122	70-122	70-122
3.2	40-71	40-71	40-71	79-141	79-141	79-141	31-49	31-49	31-49	61-101	61-101	61-101
3.3	35-49	35-49	35-49	70-101	70-101	70-101	25-36	25-36	25-36	49-71	49-71	49-71
3.4	25-40	25-40	25-40	49-80	49-80	49-80	20-31	20-31	20-31	40-61	41-61	41-61
4.1	61-101	61-101	61-101	121-199	121-199	121-199	35-61	35-61	35-61	70-121	70-122	70-122
4.2	40-61	40-61	40-61	79-122	79-122	79-122	25-36	25-36	25-36	49-71	50-71	50-71
4.3	20-31	20-31	20-31	40-61	40-61	40-61	16-22	16-22	16-22	31-40	31-40	31-40
5.1	61-101	61-101	61-101	121-199	121-199	121-199	35-61	35-61	35-61	70-121	70-122	70-122
5.2	31-61	31-61	31-61	61-122	61-122	61-122	20-36	20-36	20-36	40-71	40-71	40-71
5.3	20-49	20-49	20-49	40-101	40-101	40-101	16-31	16-31	16-31	31-61	31-61	31-61
6.1	100-202	100-202	100-202	197-412	197-412	197-412	61-122	61-122	61-122	121-244	197-244	197-244
6.2	129-171	129-171	129-171	257-351	257-351	257-351	100-122	100-122	100-122	200-244	197-244	197-244
6.3	129-171	129-171	129-171	257-351	257-351	257-351	100-122	100-122	100-122	200-244	197-244	197-244
6.4	22-49	22-49	22-49	50-101	50-101	50-101	20-36	20-36	20-36	40-71	41-71	41-71
7.1	151-458	151-458					100-305	100-305				
7.2	151-458	151-458					100-305	100-305				
7.3	40-80	40-80					31-61	31-61				
7.4	35-49	35-49					25-36					
8.1	79-159	79-159					61-122	61-122				
8.2	70-130	70-130					50-101	50-101				
8.3	70-130	70-130					50-101	50-101				
9.1	4-8	4-8	4-8	8-16	8-16	8-16						













SPEEDS AND FEEDS FOR MATERIAL APPLICATIONS

应用在不同加工材料的速度和进给

2 FL X-Long Endmill	3 FL X-Long Endmill	4 FL X-Long Endmill	2 FL X-Long Endmill	3 FL X-Long Endmill	4 FL X-Long Endmill	2 FL Square End, Minimill	2 FL Ball End, Minimill	4 FL Square End, Minimill	4 FL Ball End, Minimill	2 FL Square End, Minimill	2 FL Ball End, Minimill	4 FL Square End, Minimill	4 FL Ball End, Minimill
													
Uncoated	Un-coated	Uncoated	PowerA	PowerA	PowerA	Uncoated	Uncoated	Un-coated	Uncoated	PowerA	PowerA	PowerA	PowerA
315-0,-2,-4	316-0,-2,-4	317-0,-2,-4	315-0,-2,-4	316-0,-2,-4	317-0,-2,-4	307-1	307-0	307-5	307-4	307-1	307-0	307-5	307-4
vc m/min													
32-51	32-51	32-51	64-71	64-71	64-71	79-122	79-122	79-122	79-122	159-244	159-244	159-244	159-244
32-51	32-51	32-51	64-71	64-71	64-71	79-122	79-122	79-122	79-122	159-244	159-244	159-244	159-244
25-33	25-33	25-33	49-65	49-65	49-65	61-80	61-80	61-80	61-80	121-161	121-161	121-161	121-161
25-33	25-33	25-33	49-65	49-65	49-65	61-80	61-80	61-80	61-80	120-161	120-161	120-161	120-161
17-25	17-25	17-25	34-49	34-49	34-49	40-61	40-61	40-61	40-61	120-161	120-161	120-161	120-161
10-17	10-17	10-17	19-34	19-34	19-34	20-40	20-40	20-40	20-40	41-83	41-83	41-83	41-83
			16-33	16-33	16-33					41-83	41-83	41-83	41-83
			16-33	16-33	16-33					41-83	41-83	41-83	41-83
16-33	16-33	16-33	31-65	31-65	31-65	40-80	40-80	40-80	40-80	79-161	79-161	79-161	79-161
13-22	13-22	13-22	25-43	25-43	25-43	31-49	31-49	31-49	31-49	61-101	61-101	61-101	61-101
11-16	11-16	11-16	23-31	23-31	23-31	25-40	25-40	25-40	25-40	49-80	49-80	49-80	49-80
			20-28	20-28	20-28	22-37	22-37	22-37	22-37	46-68	46-68	46-68	46-68
20-33	20-33	20-33	40-65	40-65	40-65	49-80	49-80	49-80	49-80	100-153	100-153	100-153	100-153
16-28	16-28	16-28	31-55	31-55	31-55	40-71	40-71	40-71	40-71	79-141	79-141	79-141	79-141
14-20	14-20	14-20	28-40	28-40	28-40	35-49	35-49	35-49	35-49	70-101	70-101	70-101	70-101
10-16	10-16	10-16	19-31	19-31	19-31	25-40	25-40	25-40	25-40	49-80	49-80	49-80	49-80
25-40	25-40	25-40	49-80	49-80	49-80	61-101	61-101	61-101	61-101	121-199	121-199	121-199	121-199
17-25	17-25	17-25	34-49	34-49	34-49	40-61	40-61	40-61	40-61	79-122	79-122	79-122	79-122
8-13	8-13	8-13	16-25	16-25	16-25	20-31	20-31	20-31	20-31	40-61	40-61	40-61	40-61
25-40	25-40	25-40	49-81	49-81	49-81	61-101	61-101	61-101	61-101	121-199	121-199	121-199	121-199
13-25	13-25	13-25	25-49	25-49	25-49	31-61	31-61	31-61	31-61	61-122	61-122	61-122	61-122
10-22	10-22	10-22	16-40	16-40	16-40	20-49	20-49	20-49	20-49	40-101	40-101	40-101	40-101
40-80	40-80	40-80	80-161	80-161	80-161	100-202	100-202	100-202	100-202	197-412	197-412	197-412	197-412
52-69	52-69	52-69	103-138	103-138	103-138	129-171	129-171	129-171	129-171	257-351	257-351	257-351	257-351
52-69	52-69	52-69	16-40	16-40	16-40	129-171	129-171	129-171	129-171	257-351	257-351	257-351	257-351
10-22	10-22	10-22				22-49	22-49	22-49	22-49	50-101	50-101	50-101	50-101
61-183	61-183					151-458	151-458	151-458	151-458				
61-183	61-183					151-458	151-458	151-458	151-458				
16-33	16-33					40-80	40-80	40-80	40-80				
14-22	14-22					35-49	35-49	35-49	35-49				
32-65	32-65					79-159	79-159	79-159	79-159				
29-52	29-52					70-130	70-130	70-130	70-130				
29-52	29-52					70-130	70-130	70-130	70-130				
						4-8	4-8	4-8	4-8	8-16	8-16	8-16	8-16













TECHNICAL INFORMATION FOR HP ENDMILLS

高性能立铣刀的技术信息

Endmills	V4 Stub and Standard	V4 Long	V5 Stub and Standard	V5 Long	Roughers	Roughers	HY5 Stub and Standard	HY5 Long	F45 Standard	F45 Standard	AlumaZip	TwisterMill
												
Series	PowerA	PowerA	PowerA	PowerA	Uncoated	PowerA	PowerA	PowerA	Uncoated	PowerA	Uncoated	Uncoated
	500-0,-2,-4,-5,-6,-7,-8, 502-0,-2,-4,-5,-6,-7,-8	501-0,-2,-4,-5,-6,-7,-8	508-0,-2,-4,-5,-6,-7,-8, 510-0,-2,-4,-5,-6,-7,-8	509-0,-2,-4,-5,-6,-7,-8	533-0,-1,-2	533-0,-1,-2	545-0,-2,-4,-5,-6,-7,-8, 547-0,-2,-4,-5,-6,-7,-8	546-0,-2,-4,-5,-6,-7,-8	511-0,2,3,4,5	511-0,2,3,4,5	530-0,2,4,5,6	532-0
Material Group	vc m/min											
1.1	151-244	100-138	151-244	100-138	79-121	151-214	151-427	99-275				
1.2	151-244	100-138	151-244	100-138	79-121	151-214	151-427	99-275				
1.3	121-161	68-101	121-161	68-101	61-80	121-168	100-305	67-199				
1.4	121-161	68-101	121-161	68-101	61-80	121-168	100-305	67-199	67-199	100-305		
1.5	76-122	50-69	100-214	50-69	40-61	76-122	100-199	67-130	67-130	100-199		
1.6	40-77	31-51	100-214	31-51	20-40	38-80	100-199	67-130	67-130	100-199		
1.7	40-77	31-51	100-214	31-51			100-199	67-130	67-130	100-199		
1.8	40-77	31-51	100-214	31-51			100-199	67-130	67-130	100-199		
1.9												
2.1	76-244	50-101	76-244	50-101	40-80	76-168	76-244	49-159	49-159	76-244		50-101
2.2	61-183	38-61	61-183	38-61	31-49	61-100	61-183	40-122	40-122	61-183		41-61
2.3	50-92	31-51	50-92	31-51	25-40	49-80	31-92	20-61	20-61	31-92		25-55
2.4	44-61	34-49	44-61	34-49								
3.1	64-214	68-122	64-214	68-122	49-80	97-168	61-199	40-130				
3.2	55-168	61-101	55-168	61-101	40-71	79-138	50-176	31-116				
3.3	46-138	50-69	46-138	50-69	35-49	70-100	41-141	28-92				
3.4	34-101	38-61	34-101	38-61	25-40	49-80	31-92	20-61				
4.1	61-122	61-101	100-305	61-101	61-101	121-199	100-305	67-199	67-199	100-305		79-130
4.2	38-101	50-69	76-244	50-69	40-61	79-122	79-244	40-159	40-159	79-244		50-80
4.3	40-61	31-39	40-122	31-39	20-31	40-61	40-122	26-80	26-80	40-122		25-42
5.1	100-214	68-122	100-305	68-122	61-101	121-199	100-305	67-199	67-199	100-305		79-130
5.2	76-244	38-69	76-244	38-69	31-61	91-122	79-244	52-159	52-159	79-244		40-80
5.3	40-122	31-61	40-122	31-61	20-49	40-100	40-122	26-80	26-80	40-122		25-71
6.1					100-202							
6.2					129-171							197-260
6.3					129-171							197-260
6.4					20-49							41-80
7.1					49-458					363-915		
7.2					61-458					363-915		
7.3					40-80					302-762		
7.4					35-49					100-458		
8.1					79-159					197-610		
8.2					70-130					91-275		
8.3					70-130							
9.1												

SPEEDS AND FEEDS FOR MATERIAL APPLICATIONS

应用在不同加工材料的速度和进给

HyperMill	Mold Mills Standard Length	Mold Mills Standard Length	Mold Mills Standard Length	Mold Mills Long Length	Mold Mills Long Length	Mold Mills Long Length	AxMill 2 Flute Standard Length	AxMill 2 Flute Long Length	AxMill 2 Flute Stub Length	AxMill 3 Flute Standard Length	AxMill 3 Flute Long Length	AxMill 3 Flute Stub Length
												
Uncoated	Uncoated	PowerA	PowerN	Uncoated	PowerA	PowerN	Uncoated	Uncoated	Uncoated	Uncoated	Uncoated	Uncoated
528-0	540-4, -6, -8, 541-0, -2, 542-0, -1	540-4, -6, -8, 541-0, -2, 542-0, -1	540-4, -6, -8, 541-0, -2, 542-0, -1	537-0, -4, 542-2, -3, 543-1	537-0, -4, 542-2, -3, 543-1	537-0, 542-2, 543-1	514-0, -2, -4, -5, -6, -7, -8	515-0, -2, -4, -5, -6, -7	516-0, -2, -4, -5, -6, -7, -8	520-0, -2, -4, -5, -6, -7, -8	521-0, -2, -4, -5, -6, -7, -8	522-0, -2, -4, -5, -6, -7, -8
vc m/min												
	50-71	100-141	139-199	31-43	61-84	85-119						
	50-71	100-141	139-199	31-43	61-84	85-119						
	35-51	70-101	99-141	22-31	43-61	61-86						
	35-51	70-101	99-141	22-31	43-61	61-86						
	26-36	50-71	70-100	16-22	31-43	43-61						
	16-31	31-61	43-86	13-23	19-37	26-52						
	16-31	31-61	43-86	13-23	19-37	26-52						
	16-31	31-61	43-86	13-23	19-37	26-52						
	26-51	50-101	70-141	19-37	31-61	43-86						
	22-31	41-61	58-86	16-23	25-37	35-52						
	16-26	31-51	43-71	13-22	19-31	26-43						
	26-46	50-92	70-141	19-34	31-55	43-77						
	31-51	61-101	85-141	23-37	37-61	52-86						
	26-36	50-71	58-86	19-26	31-43	43-61						
	22-31	41-61	58-86	16-23	25-37	35-52						
	35-61	70-122	99-171	22-45	43-74	61-104						
	26-36	50-71	70-100	19-26	31-43	43-61						
	16-22	31-42	43-58	13-16	19-25	26-36						
	35-61	70-122	99-171	22-45	43-74	61-104						
	22-36	41-71	58-100	16-22	25-43	35-61						
	16-31	31-61	43-86	13-23	19-37	26-52						
	61-122	121-244	170-336	44-89	73-147	103-205						
	99-122	197-244	272-336	71-89	118-147	166-206	242-305	242-305	242-305	242-305	242-305	242-305
	99-122	197-244	272-336	71-89	118-147	166-206	182-275	182-275	182-275	182-275	182-275	182-275
	22-36	41-71	58-100	16-22	25-43	35-61	129-171	129-171	129-171	129-171	129-171	129-171
							20-49	20-49	20-49	20-49	20-49	20-49
363-915							363-762	363-762	363-762	363-762	363-762	363-762
363-915							182-366	182-366	182-366	182-366	182-366	182-366
302-762							151-244	151-244	151-244	151-244	151-244	151-244
100-458							91-183	91-183	91-183	91-183	91-183	91-183
197-610							197-610	197-610	197-610	197-610	197-610	197-610
91-275							91-275	91-275	91-275	91-275	91-275	91-275
							70-130	70-130	70-130	70-130	70-130	70-130

Terms and Conditions - 商务条款

To Order

Faxed or e-mailed orders are required. Please specify quantity and EDP/Part numbers.

Minimum Orders: \$50 for standard items, \$200 for special orders. Orders below \$50 are subject to a \$7.50 handling fee.

Standard Payment Terms

Overseas customers: Prepaid.

US customers: Net 30 Days, pending credit approval, past due after 30 days from billing date.

Freight

International orders are shipped under the Incoterm ExWorks. Mastercut Tool Corp. offers daily service with FedEx and UPS. Shipments made Pre-Pay & Add on Mastercut's FedEx or UPS accounts are subject to a \$2.50 handling fee for domestic shipments and a \$25.00 handling fee for international shipments. We are also happy to utilize any freight carrier when shipping on a collect or third-party account, with no additional handling fee.

Return Policy

We do not accept returns on items which we do not maintain in stock. Returns are subject to a 25% re-stocking fee. No returns on specials. No returns will be accepted beyond 2 months from date of shipment.

Additional Offerings

Special Tooling for your requirements.

When you need a non-standard tool for a specific job, give us a call. Requirements for special tooling or modifications of existing standard items will be given prompt, expert attention.

订购

传真和邮件订购请注明数量和电子数据或零件编号。

标准件的最小订单金额为 \$50，特殊订货为 \$200。低于 \$50 的订单需收取 \$7.50 的手续费。

标准付款条件

海外客户：预付

美国客户：货到 30 天，等待信贷审批，在出单日 30 天后结算。

运费

国际订单条款是FOB,迈斯卡美国工厂。我们公司支持 FedEx 和 UPS 每日递送服务。使用迈斯卡刀具公司 FedEx 和 UPS 帐户预付和并加服务发货，国内发运须收取 \$2.50 的手续费，国际发运须收取 \$25.00 的手续费。若收件方或第三方帐户不加收额外手续费，我们也很乐意使用其他承运人。

退货政策

若退货商品无库存，我们将不接受退货。退货须收取 25% 的返库费。特制价商品不接受退货。超出装船日起 2 个月不接受退货

特制刀具定制

若您需要用于特殊加工的非标准刀具，欢迎致电。若您需要特殊刀具或想修改现有标准产品，我们将即时为您提供特别服务。



Please contact us for
our full line of fractional
products

请联系我们获取我们的全系
列英制产品



Metric catalog available in the
following languages:

度量目录以这些语言提供:

Chinese
English
French
German
Italian

Japanese
Korean
Portuguese
Russian
Spanish



SOLID CARBIDE ENDMILLS
标准立铣刀



HIGH PERFORMANCE ENDMILLS
高性能立铣刀

PRO+ PERFORMANCE
超性能立铣刀



ROUTERS FOR WOOD, PLASTIC, AND FIBERGLASS
木材、塑料和复合材料用雕刻铣刀

DRILLS, COUNTERSINKS
硬质合金钻头, 沉孔钻

REAMERS
绞刀



CARBIDE BURS
硬质合金旋转锉



Mastercut Tool Corp. - Corporate Headquarters
965 Harbor Lake Dr.
Safety Harbor, Florida 34695 USA
Tel: (727) 726-5336
Fax: (727) 725-2532

Mastercut Tool Corp. - European Warehouse
Heliumstraat 8
7463PL Rijssen
Netherlands
Tel: +31 404 002839

Email: sales@mastercuttool.com
Web: www.mastercuttool.com



Proudly Distributed By:

