

MasterCut

Tool Corp.

*The Cutting Edge **M**astered*



English - 한국어



INTERNATIONAL PRODUCT CATALOG

ENDMILLS • DRILLS • BURS

국제 제품 카탈로그

엔드밀 • 드릴 • 버

1985	Incorporated in Safety Harbor, Florida	플로리다주 세이프티하버에 법인 설립
1986	Form grinding and brazing operations are added	폼 연삭 및 브레이징 작업 추가
1989	Company builds its first machine for manufacturing burs	최초의 버 제조용 기계 제작
1989	First CNC machine is purchased to help with quality and growth	품질과 성장을 돕기 위해 최초의 CNC 기계 구입
1991	Production of endmills commences	엔드밀 생산 시작
1994	5 and 6 axis CNC machines purchased for volume production of burs, endmills and drills	버, 엔드밀 및 드릴의 대량 생산을 위해 5축 및 6축 CNC 기계 구입
1995	Laser marking introduced; laser inspection systems implemented	레이저 마킹 도입; 레이저 검사 시스템 구현
1999	Cell concept introduced in a new facility for greater production and quality control	더욱 효율적인 생산 및 품질 관리를 위해 새로운 시설에 셀 개념 도입
2002	Production of spiral router bits, drills, and reamers commences	나선형 라우터 비트, 드릴 및 리머 제작 시작
2003	ISO 9001:2000 certification achieved; first coating machine purchased	ISO 9001:2000 인증 획득; 첫 번째 코팅 기계 구입
2004	MAP, Mastercut's Automated Production system developed	Mastercut 자동 생산(MAP) 시스템 개발
2005	CNC1st team (Customers' Needs Come 1st) implemented; second coating machine added	고객의 니즈를 최우선 순위에 두는 CNC1st 팀 구현; 두 번째 코팅 기계 추가
2006	Production begins on high-performance endmills, drills, and miniature tooling	고성능 엔드밀, 드릴 및 소형 공구 생산 시작
2009	ISO 9001:2008 certification achieved	ISO 9001:2008 인증 획득
2011	New surface treatments introduced	새로운 표면 처리 기법 도입
2013	Nano coatings and ultra-performance tools introduced	나노 코팅 및 초 고성능 공구 도입
2015	Mastercut celebrates 30th anniversary, and facility expansion	Mastercut 창립 30주년 및 시설 확장
2016	Warehouse expansions in USA and Europe	미국과 유럽의 창고 확장
2018	ISO 9001:2015 certification achieved	ISO 9001:2015 인증 획득
2020	Mastercut celebrates 35 years of quality and innovation	Mastercut은 품질과 혁신의 35년을 기념합니다.

Today

Mastercut Tool Corp. celebrates more than 3 decades as a world class carbide cutting tool manufacturer. From inception to the present, our goal is providing the highest quality products and services to our customers. All products are still manufactured in Florida, using state of the art equipment, skilled craftspersons and our exclusive MAP technology.

Our Thanks to Our Loyal Customers and Associates

Our history would not be possible without the support of all those associated with us. We thank all of our customers and associates, as well as our community, for your dedication and loyalty. We pledge to continuously improve for you!

현재

Mastercut Tool Corp.은 오랜 전통을 지닌 세계적인 카바이드 절삭 공구 제조업체입니다. 창업 초기부터 현재까지 우리의 목표는 고객에게 최고 품질의 제품과 서비스를 제공하는 것입니다. 모든 제품은 최첨단 장비, 숙련된 기술자와 독점 MAP 기술을 사용하여 플로리다에서 제조됩니다.

충성도 높은 당사의 고객과 동료에게 감사드립니다

관련된 모든 사람들의 지원이 없었다면 당사의 역사는 가능하지 않았을 것입니다. 모든 고객과 동료, 그리고 지역사회의 헌신과 충성에 감사드립니다. 귀하를 위해 지속적인 개선을 약속드립니다!





TABLE OF CONTENTS - 목차

About Mastercut: Our History

회사 연혁 2

STANDARD ENDMILLS - 표준 엔드밀 (Page 12)		Cermet	Hardened H	Cast Iron K	Titanium S	Non-Ferrous N	Stainless M	Steel P
	Square Endmills 스퀘어 엔드밀 16	Cermet		Cast Iron K	Titanium S	Non-Ferrous N	Stainless M	Steel P
	Ball Endmills 볼 엔드밀 19	Cermet		Cast Iron K	Titanium S	Non-Ferrous N	Stainless M	Steel P
	Corner Radius Endmills 코너 반경 엔드밀 22	Cermet		Cast Iron K	Titanium S	Non-Ferrous N	Stainless M	Steel P
	50° Corner Radius Endmills 50° 코너 반경 엔드밀 24	Cermet		Cast Iron K	Titanium S	Non-Ferrous N	Stainless M	Steel P
	6 Flute Square Endmills 6 플루트 스퀘어 엔드밀 26			Cast Iron K	Titanium S		Stainless M	Steel P
	Square End Double End Endmills 스퀘어 엔드 - 더블 엔드 엔드밀 27	Cermet		Cast Iron K	Titanium S	Non-Ferrous N	Stainless M	Steel P
	Ball End Double End Endmills 볼 엔드 - 더블 엔드 엔드밀 28	Cermet		Cast Iron K	Titanium S	Non-Ferrous N	Stainless M	Steel P
	90° Drill Mills 90° 드릴 밀 29	Cermet		Cast Iron K	Titanium S	Non-Ferrous N	Stainless M	Steel P
	Square End, Straight Flute Endmills 스퀘어 엔드 스트레이트 플루트 엔드밀 30		Hardened H	Cast Iron K				Steel P
	Ball End, Straight Flute Endmills 볼 엔드 스트레이트 플루트 엔드밀 31		Hardened H	Cast Iron K				Steel P
	Square End Mini Mills 스퀘어 엔드 미니 밀 32	Cermet		Cast Iron K	Titanium S	Non-Ferrous N	Stainless M	Steel P
	Ball End Mini Mills 볼 엔드 미니 밀 33	Cermet		Cast Iron K	Titanium S	Non-Ferrous N	Stainless M	Steel P
	Short Flute Square Endmills 숏 플루트 스퀘어 엔드밀 34	Cermet		Cast Iron K	Titanium S	Non-Ferrous N	Stainless M	Steel P
	Short Flute Ball Endmills 숏 플루트 볼 엔드밀 35	Cermet		Cast Iron K	Titanium S	Non-Ferrous N	Stainless M	Steel P
	Short Flute Reduced Shank Square Endmills 숏 플루트 축소 샹크 스퀘어 엔드밀 36	Cermet		Cast Iron K	Titanium S	Non-Ferrous N	Stainless M	Steel P

TABLE OF CONTENTS - 목차

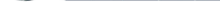
		Cermet	Hardened	Cast Iron	Titanium	Non-Ferrous	Stainless	Steel
			H	K	S	N	M	P
	Short Flute Reduced Shank Ball Endmills 숏 플루트 축소 샹크 볼 엔드밀 37	Cermet		Cast Iron K	Titanium S	Non-Ferrous N	Stainless M	Steel P
	Short Flute Necked Square Endmills 숏 플루트 넥 스퀘어 엔드밀 38	Cermet		Cast Iron K	Titanium S	Non-Ferrous N	Stainless M	Steel P
	Short Flute Necked Ball Endmills 숏 플루트 넥 볼 엔드밀 39	Cermet		Cast Iron K	Titanium S	Non-Ferrous N	Stainless M	Steel P
	Short Flute Necked Corner Radius Endmills 숏 플루트 넥 코너 반경 엔드밀 40	Cermet		Cast Iron K	Titanium S	Non-Ferrous N	Stainless M	Steel P
	Extra Long Square Endmills 엑스트라 롱 스퀘어 엔드밀 42	Cermet		Cast Iron K	Titanium S	Non-Ferrous N	Stainless M	Steel P
	Extra Length Ball Endmills 엑스트라 롱 볼 엔드밀 43	Cermet		Cast Iron K	Titanium S	Non-Ferrous N	Stainless M	Steel P

HIGH PERFORMANCE ENDMILLS - 고성능 엔드밀 (Page 44)









		Cermet	Hardened	Cast Iron	Titanium	Non-Ferrous	Stainless	Steel
			H	K	S	N	M	P
	V4, V5, HY5 Tool Features V4, V5, HY5 공구 기능 48	Cermet	Hardened H	Cast Iron K	Titanium S		Stainless M	Steel P
	F45, AxMill, HyperMill and AlumaZip Tool Features F45, 악스밀, 하이퍼밀 및 알루마집 공구 기능 49	Cermet	Hardened H	Cast Iron K	Titanium S		Stainless M	Steel P
	V4 Square Endmills V4 스퀘어 엔드밀 50	Cermet	Hardened H	Cast Iron K	Titanium S		Stainless M	Steel P
	V4 Ball Endmills V4 볼 엔드밀 52	Cermet	Hardened H	Cast Iron K	Titanium S		Stainless M	Steel P
	V4 Corner Radius Endmills V4 코너 반경 엔드밀 54	Cermet	Hardened H	Cast Iron K	Titanium S		Stainless M	Steel P
	V5 Square Endmills V5 스퀘어 엔드밀 61	Cermet	Hardened H	Cast Iron K	Titanium S		Stainless M	Steel P
	V5 Ball Endmills V5 볼 엔드밀 62	Cermet	Hardened H	Cast Iron K	Titanium S		Stainless M	Steel P
	V5 Corner Radius Endmills V5 코너 반경 엔드밀 63	Cermet	Hardened H	Cast Iron K	Titanium S		Stainless M	Steel P
	HY5 Square Endmills HY5 스퀘어 엔드밀 64	Cermet	Hardened H	Cast Iron K	Titanium S		Stainless M	Steel P

TABLE OF CONTENTS - 목차



























		Cermet	Hardened	Cast Iron	Titanium	Non-Ferrous	Stainless	Steel
		C	H	K	S	N	M	P
	HY5 코너 반경 엔드밀 HY5 코너 반경 엔드밀.....65	C	H	K	S		M	P
	F45 6FL 스퀘어 엔드밀.....70	C	H	K	S		M	P
	F45 6FL 코너 반경 엔드밀.....71	C	H	K	S		M	P
	볼 넥 몰드 밀.....72	C	H	K	S		M	P
	볼 넥 연장 길이 몰드 밀.....72	C	H	K	S		M	P
	3FL 60° 헬릭스 트위스터 밀.....73				S		M	P
	러퍼 - 거친 피치.....74	C	H	K	S	N	M	P
	러퍼 - 미세 피치.....75	C	H	K	S	N	M	P
	러퍼 - 중간 피치.....76	C	H	K	S	N	M	P
	악스밀 - 스퀘어 엔드.....77					N		
	악스밀 - 코너 반경.....78					N		
	악스밀 - 스퀘어 엔드 칩브레이커.....79					N		
	악스밀 - 코너 반경 칩브레이커.....80					N		
	45° 하이퍼밀.....81					N		
	55° 알루마집.....81					N		

TABLE OF CONTENTS - 목차

PRO+ PERFORMANCE ENDMILLS - 초고성능 엔드밀 (Page 82)

	Cermet	Hardened	Cast Iron	Titanium	Non-Ferrous	Stainless	Steel
 V4 Pro+ Square Endmills V4 울트라 스퀘어 엔드밀 84	Cermet	H	K	S		M	P
 V4 Pro+ Ball Endmills V4 울트라 볼 엔드밀 86	Cermet	H	K	S		M	P
 V4 Pro+ Corner Radius Endmills V4 울트라 코너 반경 엔드밀 88	Cermet	H	K	S		M	P
 V5 Pro+ Square Endmills V5 울트라 스퀘어 엔드밀 93	Cermet	H	K	S		M	P
 V5 Pro+ Ball Endmills V5 울트라 볼 엔드밀 94	Cermet	H	K	S		M	P
 V5 Pro+ Corner Radius Endmills V5 울트라 코너 반경 엔드밀 95	Cermet	H	K	S		M	P
 HY5 Pro+ Square Endmills HY5 울트라 스퀘어 엔드밀 96	Cermet	H	K	S		M	P
 HY5 Pro+ Corner Radius Endmills HY5 울트라 코너 반경 엔드밀 97	Cermet	H	K	S		M	P
 F45 Pro+ Square Endmills F45 울트라 6FL 스퀘어 엔드밀 102	Cermet	H	K	S		M	P
 F45 Pro+ Corner Radius Endmills F45 울트라 6FL 코너 반경 엔드밀 103	Cermet	H	K	S		M	P
 V7 Pro+ Endmills V7 울트라 103	Cermet	H	K	S		M	P

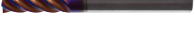
CARBIDE DRILLS - 카바이드 드릴 (Page 104)







	Cermet	Hardened	Cast Iron	Titanium	Non-Ferrous	Stainless	Steel
 2 Flute Jobber Drills 2 플루트 자버 드릴 107	Cermet	H	K	S	N	M	P
 3 Flute Jobber Drills 3 플루트 자버 드릴 108	Cermet	H	K	S	N	M	P
 Stub Drills 스텝 드릴 110	Cermet	H	K	S	N	M	P
 Medium Length Drills 중간 길이 드릴 111	Cermet	H	K	S	N	M	P
 Spade Drills 스페이드 드릴 113	Cermet	H	K	S	N	M	P
 NC Spotting Drills NC 스포팅 드릴 114	Cermet	H	K	S	N	M	P
 Drill and Countersink / Center Drills 드릴 및 카운터싱크/센터 드릴 115	Cermet	H	K	S	N	M	P

TABLE OF CONTENTS - 목차

	Cermet	H hardened	Cast Iron	Titanium	Non-Ferrous	Stainless	Steel
	H	K	S	N	M	P	
 Countersinks, 1 Flute 카운터싱크, 1 플루트..... 116		K	S	N	M	P	
 Countersinks, 3 Flute 카운터싱크, 3 플루트..... 117		K	S	N	M	P	
 Countersinks, 6 Flute 카운터싱크, 6 플루트..... 118		K	S	N	M	P	
 Chamfer Tools 챔퍼 공구..... 119	H	K	S	N	M	P	

HIGH PERFORMANCE DRILLS - 고성능 드릴 (Page 120)

	Cermet	H hardened	Cast Iron	Titanium	Non-Ferrous	Stainless	Steel
	H	K	S	N	M	P	
 Hurricane Drill High Performance Features 허리케인 드릴 고성능 기능..... 121							
 Hurricane 3xD Solid & Coolant Through 허리케인 3xD 솔리드 및 쿨런트 스루..... 122	H	K	S	N	M	P	
 Hurricane 5xD Solid & Coolant Through 허리케인 5xD 솔리드 및 쿨런트 스루..... 127	H	K	S	N	M	P	
 Hurricane 8xD Coolant Through 허리케인 8xD 쿨런트 스루..... 132	H	K	S	N	M	P	

BURS - 버 (Page 136)















	Cermet	H hardened	Cast Iron	Titanium	Non-Ferrous	Stainless	Steel
	H	K	S	N	M	P	
 SA Burs - Cylindrical Shape without End Cut SA 버 - 엔드 컷 없는 원통형..... 139	H	K	S		M	P	
 SB Burs - Cylindrical Shape with End Cut SB 버 - 엔드 컷 있는 원통형..... 140	H	K	S		M	P	
 SC Burs - Radius Cylindrical Shape SC 버 - 반경 원통형..... 141	H	K	S		M	P	
 SD Burs - Ball Shape SD 버 - 볼형..... 142	H	K	S		M	P	
 SE Burs - Oval Shape SE 버 - 타원형..... 143	H	K	S		M	P	
 SF Burs - Radius Tree Shape SF 버 - 반경 트리형..... 144	H	K	S		M	P	
 SG Burs - Pointed Tree Shape SG 버 - 뾰족한 트리형..... 145	H	K	S		M	P	

TABLE OF CONTENTS - 목차

	Cermet	Hardened	Cast Iron	Titanium	Non-Ferrous	Stainless	Steel
	H	K	S	N	M	P	
 SH Burs - Flame Shape SH 버 - 불꽃형 146	H	K	S		M	P	
 SJ Burs - 60° Included Cone Shape SJ 버 - 60° 포함 원뿔형 147	H	K	S		M	P	
 SK Burs - 90° Included Cone Shape SK 버 - 90° 포함 원뿔형 147	H	K	S		M	P	
 SL Burs - Radius Cone Shape SL 버 - 반경 원뿔형 148	H	K	S		M	P	
 SM Burs - Pointed Cone Shape SM 버 - 뾰족한 원뿔형 149	H	K	S		M	P	
 SN Burs - Inverted Cone Shape SN 버 - 역원뿔형 150	H	K	S		M	P	

BURS - ROUTERS AND SPECIAL APPLICATION 버 - 라우터 및 특수 응용 분야

 Fiberglass Routers 유리섬유 라우터 151	N/A						
 Diemills Diemills 152	H	K	S		M	P	
 Piloted Diemills Piloted Diemills 153	H	K	S		M	P	
 Tire Burs 타이어 버 154	N/A						

BUR SETS - 버 세트



 Plastic Pouch Bur Sets 플라스틱 파우치 버 세트 154	H	K	S		M	P
 12 Piece Plastic Box Bur Sets 12조 플라스틱 박스 버 세트 155	H	K	S		M	P
 24 Piece Countertop Displays 24조 카운터톱 디스플레이 155	H	K	S		M	P

TABLE OF CONTENTS - 목차



















FRACTIONAL PRODUCTS - 프랙셔널 제품 (Page 156)		Cermet	Hardened	Cast Iron	Titanium	Non-Ferrous	Stainless	Steel
		C	H	K	S	N	M	P
	Fractional Square Endmills 프랙셔널 스퀘어 엔드밀 160	C		K	S	N	M	P
	Fractional Ball Endmills 프랙셔널 볼 엔드밀 161	C		K	S	N	M	P
	Fractional Corner Radius Endmills 프랙셔널 코너 반경 엔드밀 162	C		K	S	N	M	P
	Fractional 90° Drill Mills 프랙셔널 90° 드릴 밀 163	C		K	S	N	M	P
	Fractional Square End Mini Mills 프랙셔널 스퀘어 엔드 미니 밀 164	C		K	S	N	M	P
	Fractional Ball End Mini Mills 프랙셔널 볼 엔드 미니 밀 165	C		K	S	N	M	P
	Fractional V4 Square Endmills 프랙셔널 V4 스퀘어 엔드밀 166	C	H	K	S		M	P
	Fractional V4 Ball Endmills 프랙셔널 V4 볼 엔드밀 167	C	H	K	S		M	P
	Fractional V4 Corner Radius Endmills 프랙셔널 V4 코너 반경 엔드밀 168	C	H	K	S		M	P
	Fractional V5 Square Endmills 프랙셔널 V5 스퀘어 엔드밀 169	C	H	K	S		M	P
	Fractional V5 Ball Endmills 프랙셔널 V5 볼 엔드밀 170	C	H	K	S		M	P
	Fractional V5 Corner Radius Endmills 프랙셔널 V5 코너 반경 엔드밀 171	C	H	K	S		M	P
	Fractional F45 6 Flute Square Endmills 프랙셔널 F45 6 플루트 스퀘어 엔드밀 172	C	H	K	S		M	P
	Fractional F45 6 Flute Corner Radius Endmills 프랙셔널 F45 6 플루트 코너 반경 엔드밀 173	C	H	K	S		M	P
	Fractional Square End AxMills 프랙셔널 스퀘어 엔드 악스밀 174					N		
	Fractional Jobber Drills 프랙셔널 자버 드릴 175	C	H	K	S	N	M	P
	Fractional Spade Drills 프랙셔널 스페이드 드릴 178	C	H	K	S	N	M	P
	Fractional NC Spotting Drills 프랙셔널 NC 스포팅 드릴 179	C	H	K	S	N	M	P

TABLE OF CONTENTS - 목차









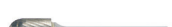

		Cermet	Hardened	Cast Iron	Titanium	Non-Ferrous	Stainless	Steel
		C	H	K	S	N	M	P
	Fractional Drill and Countersink/Centerdrill 프랙셔널 드릴 및 카운터싱크/센터드릴 180	C	H	K	S	N	M	P
	Fractional SA Bur - Cylindrical Shape without End Cut 프랙셔널 SA 버 - 엔드 컷 없는 원통형 181		H	K		N	M	P
	Fractional SB Bur - Cylindrical with Endcut 프랙셔널 SB 버 - 엔드 컷 있는 원통형 182		H	K		N	M	P
	Fractional SC Bur - Radius Cylindrical Shape 프랙셔널 SC 버 - 반경 원통형 183		H	K		N	M	P
	Fractional SD Bur - Ball Shape 프랙셔널 SD 버 - 볼형 184		H	K		N	M	P
	Fractional SE Bur - Oval Shape 프랙셔널 SE 버 - 타원형 185		H	K		N	M	P
	Fractional SF Bur - Radius Tree Shape 프랙셔널 SF 버 - 반경 트리형 186		H	K		N	M	P
	Fractional SG Bur - Pointed Tree Shape 프랙셔널 SG 버 - 뾰족한 트리형 187		H	K		N	M	P
	Fractional SH Bur - Flame Shape 프랙셔널 SH 버 - 불꽃형 187		H	K		N	M	P
	Fractional SL Bur - Radius Cone Shape 프랙셔널 SL 버 - 반경 원뿔형 188		H	K		N	M	P
	Fractional SM Bur - Pointed Cone Shape 프랙셔널 SM 버 - 뾰족한 원뿔형 189		H	K		N	M	P

TABLE OF CONTENTS - 목차

COATINGS - 코팅 (Page 190)



Mastercut Coating Options

Mastercut 코팅 옵션 190

Available Coatings 192

가능한 코팅 193

TECHNICAL INFORMATION - 기술 정보 (Page 194)

Technical Information 195

기술 정보 196

Technical Information for AxMills

악스밀 기술 정보 197

Technical Information for HP Drills

HP 드릴 기술 정보 197

Mastercut Troubleshooting Guides

Mastercut 문제해결 가이드 198

Troubleshooting Guide Solution Keys

문제해결 가이드 솔루션 키 201

Technical Information Materials Groupings

기술 정보 재료 그룹 202

Technical Information for Endmills

엔드밀 기술 정보 204

Technical Information for HP Endmills

HP 엔드밀 기술 정보 206

TERMS AND CONDITIONS - 이용 약관 (Page 208)

Terms and Conditions 208

이용 약관 208

STANDARD ENDMILLS

표준 엔드밀

- **Square End** - 스퀘어 엔드
- **Ball End** - 볼 엔드
- **Corner Radius** - 코너 반경
- **Double End** - 더블 엔드
- **Drill Mills** - 드릴 밀
- **Mini Mills** - 미니 밀



Customers' Needs Come First! This is what truly matters to us. To ensure you the fastest possible service, we have assembled simulation, engineering, production scheduling, customer service, and inventory personnel into one unit. They collaborate on any and all special requests from you, the moment your request is received. They are dedicated and qualified to assist you with solutions, fast!

고객의 니즈를 최우선으로! 이는 우리에게 정말로 중요한 목표입니다. 가능한 가장 빠른 서비스를 보장하기 위해 시뮬레이션, 엔지니어링, 생산 일정 및 인벤토리 인력을 하나의 단위로 구성했으며, 따라서 어떠한 특별한 요청이든 귀하의 요청이 접수되는 즉시 협력할 수 있습니다. 이들은 자격을 갖춘 전담 인력으로, 신속하게 해결책을 제시할 것입니다!

LEGENDS

범례



Features

기능

	2 Flutes 2 플루트		Multi-Flute 멀티 플루트		Ball End 볼 엔드
	3 Flutes 3 플루트		Plain Shank 플레인 샹크		Double End Sq. 더블 엔드 스퀘어
	4 Flutes 4 플루트		Corner Radius 코너 반경		Double End Ball 더블 엔드 볼
	6 Flutes 6 플루트		Square End 스퀘어 엔드		

Coatings

Покрyтия

	PowerA PowerA (Aluminum Titanium Nitride - AlTiN)		Uncoated 비코팅
---	---	---	-----------------

Superior Carbide Blend 탁월한 카바이드 혼합

Mastercut's Superior Carbide Blend – A-Gr-SiV (Active Grain Sized Volume)

Our superior tungsten carbide gives you the ability to be *aggressive* when you need to be. Growth inhibitors in our submicron carbide blanks maintain the most consistent grain size available, giving you superior hardness and toughness.

Mastercut의 탁월한 카바이드 혼합 – A-Gr-SiV(액티브 결정 입도 볼륨)

당사의 우수한 텅스텐 카바이드는 귀하가 필요할 때 공격적으로 대응할 수 있는 능력을 제공합니다. 당사의 서브 마이크론 카바이드 블랭크의 성장 억제제는 가장 균일한 결정 입도를 유지하며, 탁월한 경도와 인성을 제공합니다.

TABLE OF CONTENTS - 목차











































































































































	Square Endmills 스퀘어 엔드밀 16						
	Ball Endmills 볼 엔드밀 19						
	Corner Radius Endmills 코너 반경 엔드밀 22						
	50° Corner Radius Endmills 50° 코너 반경 엔드밀 24						
	6 Flute Square Endmills 6 플루트 스퀘어 엔드밀 26						
	Square End Double End Endmills 스퀘어 엔드 - 더블 엔드 엔드밀 27						
	Ball End Double End Endmills 볼 엔드 - 더블 엔드 엔드밀 28						
	90° Drill Mills 90° 드릴 밀 29						
	Square End, Straight Flute Endmills 스퀘어 엔드 스트레이트 플루트 엔드밀 30						
	Ball End, Straight Flute Endmills 볼 엔드 스트레이트 플루트 엔드밀 31						
	Square End Mini Mills 스퀘어 엔드 미니 밀 32						

TABLE OF CONTENTS - 목차

	Ball End Mini Mills 볼 엔드 미니 밀 33		    
	Short Flute Square Endmills 숏 플루트 스퀘어 엔드밀 34		    
	Short Flute Ball Endmills 숏 플루트 볼 엔드밀 35		    
	Short Flute Reduced Shank Square Endmills 숏 플루트 축소 생크 스퀘어 엔드밀 36		    
	Short Flute Reduced Shank Ball Endmills 숏 플루트 축소 생크 볼 엔드밀 37		    
	Short Flute Necked Square Endmills 숏 플루트 넥 스퀘어 엔드밀 38		    
	Short Flute Necked Ball Endmills 숏 플루트 넥 볼 엔드밀 39		    
	Short Flute Necked Corner Radius Endmills 숏 플루트 넥 코너 반경 엔드밀 40		    
	Extra Long Square Endmills 엑스트라 롱 스퀘어 엔드밀 42		    
	Extra Length Ball Endmills 엑스트라 롱 볼 엔드밀 43		    

SQUARE ENDMILLS

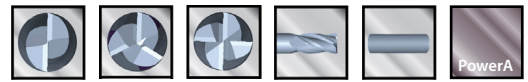

표준 엔드밀

Standard, Stub and Long	2, 3 and 4 Flutes	Coated and Uncoated
표준, 스텝 및 롱	2, 3 및 4 플루트	코팅 및 비코팅

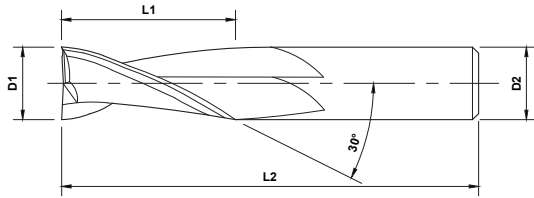

Stub, Series 313



Standard, Series 309,310,311



Long, Series 304

X-Long, Series 315, 317

Length Key (K)

■ Stub
 ■ Standard
 ■ Long
 ■ X-Long

Quick Ship Items



K	OD	LOC	SHK	OAL	Uncoated			PowerA					
					D1	L1	D2	L2	2 Flute	3 Flute	4 Flute	2 Flute	3 Flute
1			3	38	2	3	38	313-102	-	313-702	313-102-1	-	313-702-1
					3	3	38	309-202	310-202	311-202	309-202-1	310-202-1	311-202-1
1.5			3	38	3	3	38	313-104	-	313-704	313-104-1	-	313-704-1
					5	3	38	309-204	310-204	311-204	309-204-1	310-204-1	311-204-1
2			3	38	4	3	38	313-106	-	313-706	313-106-1	-	313-706-1
					6	3	38	309-206	310-206	311-206	309-206-1	310-206-1	311-206-1
2.5			3	38	5	3	38	313-108	-	313-708	313-108-1	-	313-708-1
					7	3	38	309-208	310-208	311-208	309-208-1	310-208-1	311-208-1
3			3	38	6	3	38	313-110	-	313-710	313-110-1	-	313-710-1
					12	3	38	309-210	310-210	311-210	309-210-1	310-210-1	311-210-1
					25	3	65	304-202	-	306-202	304-202-1	-	306-202-1

SQUARE ENDMILLS

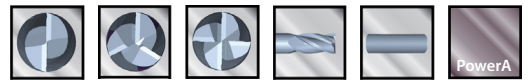

표준 엔드밀

Length Key (K)

■ Stub
 ■ Standard
 ■ Long
 ■ X-Long

Quick Ship Items



K	OD	LOC	SHK	OAL	Uncoated			PowerA		
					2 Flute	3 Flute	4 Flute	2 Flute	3 Flute	4 Flute
3.5	7	4	50		313-112	-	313-712	313-112-1	-	313-712-1
	12	4	50		309-212	310-212	311-212	309-212-1	310-212-1	311-212-1
4	8	4	50		313-114	-	313-714	313-114-1	-	313-714-1
	14	4	50		309-214	310-214	311-214	309-214-1	310-214-1	311-214-1
	25	4	65		304-204	-	306-204	304-204-1	-	306-204-1
4.5	9	5	50		313-116	-	313-716	313-116-1	-	313-716-1
	14	5	50		309-216	310-216	311-216	309-216-1	310-216-1	311-216-1
5	10	5	50		313-118	-	313-718	313-118-1	-	313-718-1
	16	5	50		309-218	310-218	311-218	309-218-1	310-218-1	311-218-1
	25	5	75		304-206	-	306-206	304-206-1	-	306-206-1
6	12	6	50		313-120	-	313-720	313-120-1	-	313-720-1
	19	6	63		309-220	310-220	311-220	309-220-1	310-220-1	311-220-1
	25	6	75		304-208	-	306-208	304-208-1	-	306-208-1
	38	6	100		315-202	-	317-202	315-202-1	-	317-202-1
	75	6	150		315-204	-	317-204	315-204-1	-	317-204-1
	75	6	200		315-206	-	317-206	315-206-1	-	317-206-1
	75	8	200		315-208	-	317-208	315-208-1	-	317-208-1
7	19	8	63		309-222	310-222	311-222	309-222-1	310-222-1	311-222-1
8	12	8	50		313-122	-	313-722	313-122-1	-	313-722-1
	19	8	63		309-224	310-224	311-224	309-224-1	310-224-1	311-224-1
	25	8	75		304-210	-	306-210	304-210-1	-	306-210-1
	42	8	100		315-210	-	317-210	315-210-1	-	317-210-1
	75	8	150		315-212	-	317-212	315-212-1	-	317-212-1
	75	8	200		315-214	-	317-214	315-214-1	-	317-214-1
	75	10	200		315-216	-	317-216	315-216-1	-	317-216-1
9	22	10	70		309-226	310-226	311-226	309-226-1	310-226-1	311-226-1
10	14	10	50		313-124	-	313-724	313-124-1	-	313-724-1
	22	10	70		309-228	310-228	311-228	309-228-1	310-228-1	311-228-1
	38	10	100		304-212	-	306-212	304-212-1	-	306-212-1
	75	10	150		315-218	-	317-218	315-218-1	-	317-218-1
	75	10	200		315-220	-	317-220	315-220-1	-	317-220-1
11	25	11	70		309-230	310-230	311-230	309-230-1	310-230-1	311-230-1

SQUARE ENDMILLS

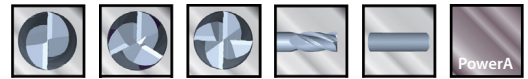

표준 엔드밀



Length Key (K)

Stub
 Standard
 Long
 X-Long

Quick Ship Items



K	OD	LOC	SHK	OAL	Uncoated			PowerA																													
					D1	L1	D2	L2	2 Flute	3 Flute	4 Flute	2 Flute	3 Flute	4 Flute																							
12	12	16	12	63	313-126	-	313-726	313-126-1	-	313-726-1																											
											25	12	75	309-232	310-232	311-232	309-232-1	310-232-1	311-232-1																		
																				50	12	100	304-214	-	306-214	304-214-1	-	306-214-1									
																													75	12	150	315-222	-	317-222	315-222-1	-	317-222-1
14	14	30	14	88	309-234	310-234	311-234	309-234-1	310-234-1	311-234-1																											
											56	14	125	304-216	-	306-216	304-216-1	-	306-216-1																		
																				62	14	125	315-226	-	317-226	315-226-1	-	317-226-1									
																													75	14	150	315-228	-	317-228	315-228-1	-	317-228-1
16	16	20	16	75	313-128	-	313-728	313-128-1	-	313-728-1																											
											32	16	88	309-236	310-236	311-236	309-236-1	310-236-1	311-236-1																		
																				75	16	150	304-218	-	306-218	304-218-1	-	306-218-1									
																													75	16	200	315-232	-	317-232	315-232-1	-	317-232-1
18	18	36	18	100	309-238	310-238	311-238	309-238-1	310-238-1	311-238-1																											
											75	18	150	304-220	-	306-220	304-220-1	-	306-220-1																		
																				75	18	200	315-234	-	317-234	315-234-1	-	317-234-1									
20	20	38	20	100	309-240	310-240	311-240	309-240-1	310-240-1	311-240-1																											
											75	20	150	304-222	-	306-222	304-222-1	-	306-222-1																		
																				75	20	200	315-236	-	317-236	315-236-1	-	317-236-1									
22	22	38	22	100	309-242	310-242	311-242	309-242-1	310-242-1	311-242-1																											
											25	25	100	309-244	310-244	311-244	309-244-1	310-244-1	311-244-1																		
75	25	150	304-224	-	306-224	304-224-1	-	306-224-1																													

BALL ENDMILLS

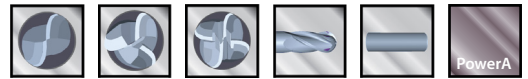

볼 엔드밀

Standard, Stub and Long	2, 3 and 4 Flutes	Coated and Uncoated
표준, 스텝 및 롱	2, 3 및 4 플루트	코팅 및 비코팅

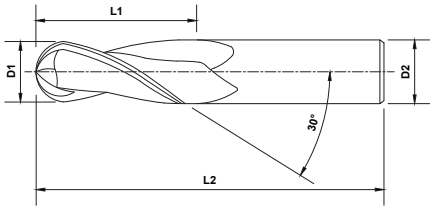

Stub, Series 313



Standard, Series 309,310,311



Long, Series 304

X-Long, Series 315, 317

Length Key (K)

■ Stub
 ■ Standard
 ■ Long
 ■ X-Long

Quick Ship Items



K	OD	LOC	SHK	OAL	Uncoated			PowerA		
					2 Flute	3 Flute	4 Flute	2 Flute	3 Flute	4 Flute
1	D1	L1	D2	L2	313-002	-	313-602	313-002-1	-	313-602-1
					309-002	310-002	311-002	309-002-1	310-002-1	311-002-1
1.5					313-004	-	313-604	313-004-1	-	313-604-1
					309-004	310-004	311-004	309-004-1	310-004-1	311-004-1
2					313-006	-	313-606	313-006-1	-	313-606-1
					309-006	310-006	311-006	309-006-1	310-006-1	311-006-1
2.5					313-008	-	313-608	313-008-1	-	313-608-1
					309-008	310-008	311-008	309-008-1	310-008-1	311-008-1
3					313-010	-	313-610	313-010-1	-	313-610-1
					309-010	310-010	311-010	309-010-1	310-010-1	311-010-1
					304-002	-	306-002	304-002-1	-	306-002-1

BALL ENDMILLS

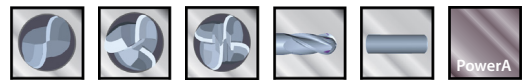

볼 엔드밀

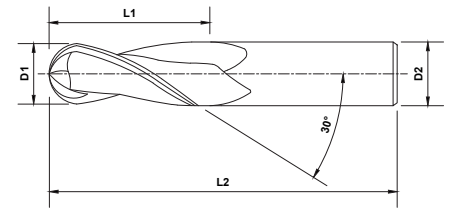

Length Key (K)

Stub
 Standard
 Long
 X-Long



Quick Ship Items



K	OD	LOC	SHK	OAL	Uncoated			PowerA		
					D1	L1	D2	L2	2 Flute	3 Flute
3.5	7	4	50	313-012	-	313-612	313-012-1	-	313-612-1	
		12	50	309-012	310-012	311-012	309-012-1	310-012-1	311-012-1	
4	8	4	50	313-014	-	313-614	313-014-1	-	313-614-1	
		14	50	309-014	310-014	311-014	309-014-1	310-014-1	311-014-1	
		25	65	304-004	-	306-004	304-004-1	-	306-004-1	
4.5	9	5	50	313-016	-	313-616	313-016-1	-	313-616-1	
		14	50	309-016	310-016	311-016	309-016-1	310-016-1	311-016-1	
5	10	5	50	313-018	-	313-618	313-018-1	-	313-618-1	
		16	50	309-018	310-018	311-018	309-018-1	310-018-1	311-018-1	
		25	75	304-006	-	306-006	304-006-1	-	306-006-1	
6	12	6	50	313-020	-	313-620	313-020-1	-	313-620-1	
		19	63	309-020	310-020	311-020	309-020-1	310-020-1	311-020-1	
	75	6	75	304-008	-	306-008	304-008-1	-	306-008-1	
		38	100	315-002	-	317-002	315-002-1	-	317-002-1	
		75	150	315-004	-	317-004	315-004-1	-	317-004-1	
		75	200	315-006	-	317-006	315-006-1	-	317-006-1	
75	8	200	315-008	-	317-008	315-008-1	-	317-008-1		
7	19	8	63	309-022	310-022	311-022	309-022-1	310-022-1	311-022-1	
8	12	8	50	313-022	-	313-622	313-022-1	-	313-622-1	
		19	63	309-024	310-024	311-024	309-024-1	310-024-1	311-024-1	
	75	25	75	304-010	-	306-010	304-010-1	-	306-010-1	
		42	100	315-010	-	317-010	315-010-1	-	317-010-1	
		75	150	315-012	-	317-012	315-012-1	-	317-012-1	
		75	200	315-014	-	317-014	315-014-1	-	317-014-1	
75	10	200	315-016	-	317-016	315-016-1	-	317-016-1		
9	22	10	70	309-026	310-026	311-026	309-026-1	310-026-1	311-026-1	
10	14	10	50	313-024	-	313-624	313-024-1	-	313-624-1	
		22	70	309-028	310-028	311-028	309-028-1	310-028-1	311-028-1	
	75	38	100	304-012	-	306-012	304-012-1	-	306-012-1	
		75	150	315-018	-	317-018	315-018-1	-	317-018-1	
75	10	200	315-020	-	317-020	315-020-1	-	317-020-1		

BALL ENDMILLS

볼 엔드밀

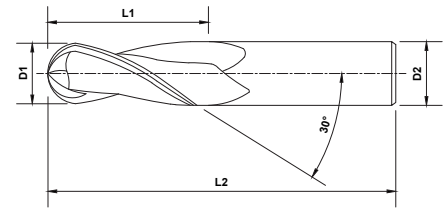
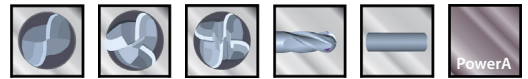

Length Key (K)



Quick Ship Items



K	OD D1	LOC L1	SHK D2	OAL L2	Uncoated			PowerA		
					2 Flute	3 Flute	4 Flute	2 Flute	3 Flute	4 Flute
11	25	11	70		309-030	310-030	311-030	309-030-1	310-030-1	311-030-1
	16	12	63		313-026	-	313-626	313-026-1	-	313-626-1
	25	12	75		309-032	310-032	311-032	309-032-1	310-032-1	311-032-1
12	50	12	100		304-014	-	306-014	304-014-1	-	306-014-1
	75	12	150		315-022	-	317-022	315-022-1	-	317-022-1
	75	12	200		315-024	-	317-024	315-024-1	-	317-024-1
14	30	14	88		309-034	310-034	311-034	309-034-1	310-034-1	311-034-1
	56	14	125		304-016	-	306-016	304-016-1	-	306-016-1
	62	14	125		315-026	-	317-026	315-026-1	-	317-026-1
	75	14	150		315-028	-	317-028	315-028-1	-	317-028-1
	75	16	200		315-030	-	317-030	315-030-1	-	317-030-1
16	20	16	75		313-028	-	313-628	313-028-1	-	313-628-1
	32	16	88		309-036	310-036	311-036	309-036-1	310-036-1	311-036-1
	75	16	150		304-018	-	306-018	304-018-1	-	306-018-1
	75	16	200		315-032	-	317-032	315-032-1	-	317-032-1
18	36	18	100		309-038	310-038	311-038	309-038-1	310-038-1	311-038-1
	75	18	150		304-020	-	306-020	304-020-1	-	306-020-1
	75	18	200		315-034	-	317-034	315-034-1	-	317-034-1
20	38	20	100		309-040	310-040	311-040	309-040-1	310-040-1	311-040-1
	75	20	150		304-022	-	306-022	304-022-1	-	306-022-1
	75	20	200		315-036	-	317-036	315-036-1	-	317-036-1
22	38	22	100		309-042	310-042	311-042	309-042-1	310-042-1	311-042-1
	38	25	100		309-044	310-044	311-044	309-044-1	310-044-1	311-044-1
25	38	25	100		309-044	310-044	311-044	309-044-1	310-044-1	311-044-1
	75	25	150		304-024	-	306-024	304-024-1	-	306-024-1

CORNER RADIUS ENDMILLS



코너 반경 엔드밀

2 and 4 Flutes	Coated and Uncoated
2 및 4 플루트	코팅 및 비코팅

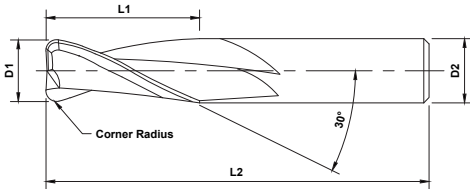

Stub, Series 309,311



Standard, Series 309,311



Long, Series 309,311

Length Key (K)

■ Stub
 ■ Standard
 ■ Long

Quick Ship Items



K	OD	LOC	SHK	OAL	Radius	Uncoated		PowerA	
						2 Flute	4 Flute	2 Flute	4 Flute
	D1	L1	D2	L2	R				
2	6	3	38	0.50	309-401	311-401	309-401-1	311-401-1	
	12	3	38	0.50	309-411	311-411	309-411-1	311-411-1	
4	14	4	50	0.25	309-420	311-420	309-420-1	311-420-1	
	14	4	50	0.50	309-421	311-421	309-421-1	311-421-1	
	14	4	50	0.75	309-422	311-422	309-422-1	311-422-1	
	14	4	50	1.00	309-423	311-423	309-423-1	311-423-1	
5	16	5	50	0.50	309-431	311-431	309-431-1	311-431-1	
6	19	6	63	0.25	309-440	311-440	309-440-1	311-440-1	
	19	6	63	0.50	309-441	311-441	309-441-1	311-441-1	
	19	6	63	0.75	309-442	311-442	309-442-1	311-442-1	
	19	6	63	1.00	309-443	311-443	309-443-1	311-443-1	
	19	6	63	1.25	309-444	311-444	309-444-1	311-444-1	
	19	6	63	1.50	309-445	311-445	309-445-1	311-445-1	
8	19	8	63	0.25	309-450	311-450	309-450-1	311-450-1	
	19	8	63	0.50	309-451	311-451	309-451-1	311-451-1	
	19	8	63	0.75	309-452	311-452	309-452-1	311-452-1	
	19	8	63	1.00	309-453	311-453	309-453-1	311-453-1	
	19	8	63	1.25	309-454	311-454	309-454-1	311-454-1	
	19	8	63	1.50	309-455	311-455	309-455-1	311-455-1	
	19	8	63	2.00	309-456	311-456	309-456-1	311-456-1	

CORNER RADIUS ENDMILLS



코너 반경 엔드밀

Corner radius for extra strength and precision

추가 강도 및 정밀도를 위한 코너 반경



Length Key (K)

■ Stub
 ■ Standard
 ■ Long

Quick Ship Items



K	OD	LOC	SHK	OAL	Radius	Uncoated		PowerA	
						2 Flute	4 Flute	2 Flute	4 Flute
10	25	10	70	0.25	309-460	311-460	309-460-1	311-460-1	
				0.50	309-461	311-461	309-461-1	311-461-1	
				0.75	309-462	311-462	309-462-1	311-462-1	
				1.00	309-463	311-463	309-463-1	311-463-1	
				1.25	309-464	311-464	309-464-1	311-464-1	
				1.50	309-465	311-465	309-465-1	311-465-1	
				2.00	309-466	311-466	309-466-1	311-466-1	
				3.00	309-467	311-467	309-467-1	311-467-1	
12	25	12	75	0.25	309-470	311-470	309-470-1	311-470-1	
				0.50	309-471	311-471	309-471-1	311-471-1	
				0.75	309-472	311-472	309-472-1	311-472-1	
				1.00	309-473	311-473	309-473-1	311-473-1	
				1.25	309-474	311-474	309-474-1	311-474-1	
				1.50	309-475	311-475	309-475-1	311-475-1	
				2.00	309-476	311-476	309-476-1	311-476-1	
				3.00	309-477	311-477	309-477-1	311-477-1	
16	32	16	88	0.25	309-480	311-480	309-480-1	311-480-1	
				0.50	309-481	311-481	309-481-1	311-481-1	
				0.75	309-482	311-482	309-482-1	311-482-1	
				1.00	309-483	311-483	309-483-1	311-483-1	
				1.25	309-484	311-484	309-484-1	311-484-1	
				1.50	309-485	311-485	309-485-1	311-485-1	
				2.00	309-486	311-486	309-486-1	311-486-1	
				3.00	309-487	311-487	309-487-1	311-487-1	
20	38	20	100	0.25	309-490	311-490	309-490-1	311-490-1	
				0.50	309-491	311-491	309-491-1	311-491-1	
				0.75	309-492	311-492	309-492-1	311-492-1	
				1.00	309-493	311-493	309-493-1	311-493-1	
				1.25	309-494	311-494	309-494-1	311-494-1	
				1.50	309-495	311-495	309-495-1	311-495-1	
				2.00	309-496	311-496	309-496-1	311-496-1	
				3.00	309-497	311-497	309-497-1	311-497-1	

50° HELIX CORNER RADIUS ENDMILLS

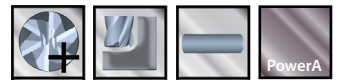

50° 헬릭스 코너 반경 엔드밀

6 and 8 Flutes	Coated
6 및 8 플루트	코팅

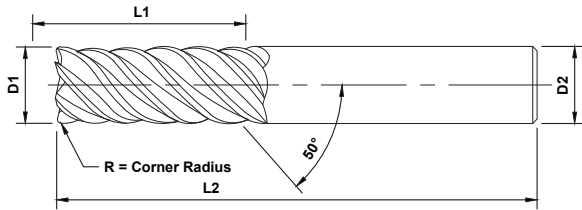

Standard, Series 534-0



Long, Series, 534-2

Length Key (K)

■ Stub
 ■ Standard
 ■ Long



K	OD	LOC	SHK	OAL	Radius	Flutes	PowerA
	D1	L1	D2	L2	R		PartID
6	6	18	6	58	0.5	6	534-002-1
		18	6	58	1	6	534-004-1
		32	6	75	0.5	6	534-202-1
		32	6	75	1	6	534-204-1
8	8	24	8	63	0.5	6	534-006-1
		24	8	63	1	6	534-008-1
		32	8	75	0.5	6	534-206-1
		32	8	75	1	6	534-208-1
10	10	30	10	75	0.5	6	534-010-1
		30	10	75	1	6	534-012-1
		50	10	100	0.5	6	534-210-1
		50	10	100	1	6	534-212-1
12	12	36	12	84	0.5	6	534-014-1
		36	12	84	1	6	534-016-1
		50	12	100	0.5	6	534-214-1
		50	12	100	1	6	534-216-1

50° HELIX CORNER RADIUS ENDMILLS

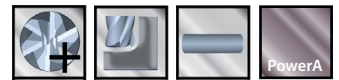

50° 헬릭스 코너 반경 엔드밀

Corner radius for extra strength and precision
 추가 강도 및 정밀도를 위한 코너 반경



Length Key (K)

■ Stub
 ■ Standard
 ■ Long



K	OD	LOC	SHK	OAL	Radius	Flutes	PowerA
	D1	L1	D2	L2	R		PartID
14		42	14	84	0.5	6	534-018-1
		42	14	84	1	6	534-020-1
		50	14	100	0.5	6	534-218-1
		50	14	100	1	6	534-220-1
16		48	16	93	0.5	8	534-022-1
		48	16	93	1	8	534-024-1
		62	16	125	0.5	8	534-222-1
		62	16	125	1	8	534-224-1
18		54	18	100	0.5	8	534-026-1
		54	18	100	1	8	534-028-1
		62	18	125	0.5	8	534-226-1
		62	18	125	1	8	534-228-1
20		60	20	105	0.5	8	534-030-1
		60	20	105	1	8	534-032-1
		65	20	130	0.5	8	534-230-1
		65	20	130	1	8	534-232-1

6 FLUTE SQUARE END

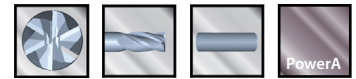

6 플루트 스퀘어 엔드

6 Flutes	Coated and Uncoated	6 flutes for superior finish
6 플루트	코팅 및 비코팅	탁월한 마감을 위한 6 플루트

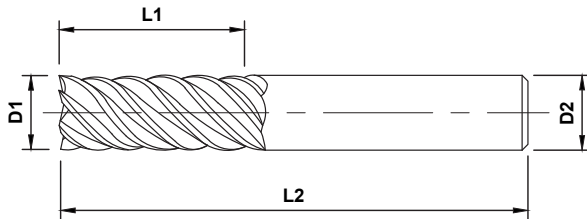

Series 312

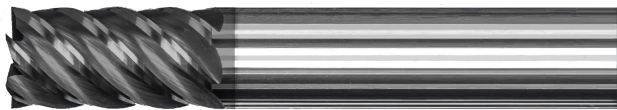

Series 312, Power A

Length Key (K)

■ Stub
 ■ Standard
 ■ Long



K	OD	LOC	SHK	OAL	Uncoated	PowerA
	D1	L1	D2	L2	Part ID	Part ID
K	3	12	3	38	312-210	312-210-1
	4	14	4	50	312-214	312-214-1
	5	16	5	50	312-218	312-218-1
	6	19	6	63	312-220	312-220-1
	7	19	8	63	312-222	312-222-1
	8	21	8	63	312-224	312-224-1
	9	22	10	70	312-226	312-226-1
	10	25	10	70	312-228	312-228-1
	11	25	11	70	312-230	312-230-1
	12	25	12	75	312-232	312-232-1
	14	30	14	88	312-234	312-234-1
	16	32	16	88	312-236	312-236-1
	18	35	18	100	312-238	312-238-1
	20	38	20	100	312-240	312-240-1
	22	38	22	100	312-242	312-242-1
	25	38	25	100	312-244	312-244-1

SQUARE END • DOUBLE END



스퀘어 엔드 - 더블 엔드

2 and 4 Flutes	Coated and Uncoated
2 및 4 플루트	코팅 및 비코팅

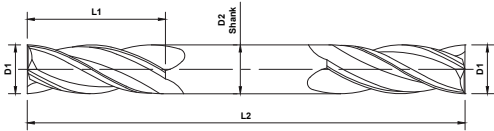

- Standard, Series 301
- Stub, Series 302



- Standard, Series 301 PowerA
- Stub, Series 302 PowerA

Length Key (K)

■ Stub
 ■ Standard
 ■ Long



K	OD	LOC	SHK	OAL	Uncoated		PowerA	
					2 Flute	4 Flute	2 Flute	4 Flute
	D1	L1	D2	L2				
1	1	2	3	38	302-102	302-302	302-102-1	302-302-1
	1.5	3	3	38	302-104	302-304	302-104-1	302-304-1
	2	4	3	38	302-106	302-306	302-106-1	302-306-1
	2.5	5	3	38	302-108	302-308	302-108-1	302-308-1
3	3	6	3	38	302-110	302-310	302-110-1	302-310-1
	3.5	9	3	50	301-102	301-302	301-102-1	301-302-1
4	4	7	4	50	302-112	302-312	302-112-1	302-312-1
	4.5	8	4	50	302-114	302-314	302-114-1	302-314-1
5	5	10	4	63	301-104	301-304	301-104-1	301-304-1
	5.5	10	5	50	302-116	302-316	302-116-1	302-316-1
6	6	10	5	50	302-118	302-318	302-118-1	302-318-1
	6.5	12	5	63	301-106	301-306	301-106-1	301-306-1
7	7	12	6	63	302-120	302-320	302-120-1	302-320-1
	7.5	16	6	63	301-108	301-308	301-108-1	301-308-1
8	8	10	7	63	302-122	302-322	302-122-1	302-322-1
	8.5	12	8	63	302-124	302-324	302-124-1	302-324-1
9	9	18	8	75	301-110	301-310	301-110-1	301-310-1
	9.5	12	9	70	302-126	302-326	302-126-1	302-326-1
10	10	12	10	70	302-128	302-328	302-128-1	302-328-1
	10.5	18	10	75	301-112	301-312	301-112-1	301-312-1
11	11	12	11	70	302-130	302-330	302-130-1	302-330-1
	11.5	16	12	75	302-132	302-332	302-132-1	302-332-1
12	12	25	12	100	301-114	301-314	301-114-1	301-314-1
	12.5	32	16	150	301-116	301-316	301-116-1	301-316-1

BALL END • DOUBLE END



볼 엔드 - 더블 엔드

2 and 4 Flutes	Coated and Uncoated
2 및 4 플루트	코팅 및 비코팅

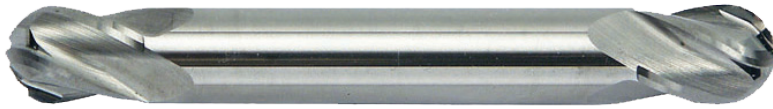
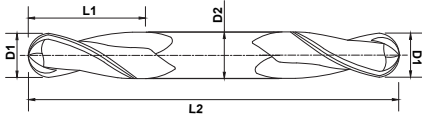

- Standard, Series 301
- Stub, Series 302



- Standard, Series 301, PowerA
- Stub, Series 302, PowerA

Length Key (K)

■ Stub
 ■ Standard
 ■ Long



K	OD	LOC	SHK	OAL	Uncoated		PowerA	
					2 Flute	4 Flute	2 Flute	4 Flute
	D1	L1	D2	L2				
1		2	3	38	302-002	302-202	302-002-1	302-202-1
1.5		3	3	38	302-004	302-204	302-004-1	302-204-1
2		4	3	38	302-006	302-206	302-006-1	302-206-1
2.5		5	3	38	302-008	302-208	302-008-1	302-208-1
3		6	3	38	302-010	302-210	302-010-1	302-210-1
		9	3	50	301-002	301-202	301-002-1	301-202-1
3.5		7	4	50	302-012	302-212	302-012-1	302-212-1
		8	4	50	302-014	302-214	302-014-1	302-214-1
4		10	4	63	301-004	301-204	301-004-1	301-204-1
		10	5	50	302-016	302-216	302-016-1	302-216-1
5		10	5	50	302-018	302-218	302-018-1	302-218-1
		12	5	63	301-006	301-206	301-006-1	301-206-1
6		12	6	63	302-020	302-220	302-020-1	302-220-1
		16	6	63	301-008	301-208	301-008-1	301-208-1
7		10	7	63	302-022	302-222	302-022-1	302-222-1
		12	8	63	302-024	302-224	302-024-1	302-224-1
8		18	8	75	301-010	301-210	301-010-1	301-210-1
		12	9	70	302-026	302-226	302-026-1	302-226-1
9		12	10	70	302-028	302-228	302-028-1	302-228-1
		18	10	75	301-012	301-212	301-012-1	301-212-1
11		12	11	70	302-030	302-230	302-030-1	302-230-1
		16	12	75	302-032	302-232	302-032-1	302-232-1
12		25	12	100	301-014	301-214	301-014-1	301-214-1
		32	16	150	301-016	301-216	301-016-1	301-216-1

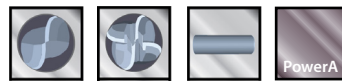

90° DRILLMILLS

90° 드릴밀

2 and 4 Flutes	Coated and Uncoated	Chamfering, countersinking, spotting, and profile milling
2 및 4 플루트	코팅 및 비코팅	챔퍼링, 카운터싱크, 스폿팅 및 프로파일 밀링

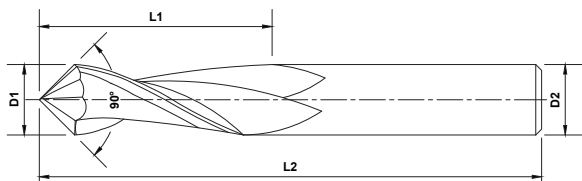

2 Flute, Series 314

4 Flute, Series 314

Length Key (K)

■ Stub
 ■ Standard
 ■ Long

Quick Ship Items



K	OD	LOC	SHK	OAL	Uncoated		PowerA	
					2 Flute	4 Flute	2 Flute	4 Flute
	D1	L1	D2	L2				
K	3	12	3	38	314-002	314-302	314-002-1	314-302-1
	4	14	4	50	314-004	314-304	314-004-1	314-304-1
	5	16	5	50	314-006	314-306	314-006-1	314-306-1
	6	19	6	63	314-008	314-308	314-008-1	314-308-1
	8	19	8	63	314-010	314-310	314-010-1	314-310-1
	10	22	10	70	314-012	314-312	314-012-1	314-312-1
	12	25	12	75	314-014	314-314	314-014-1	314-314-1
	16	32	16	88	314-016	314-316	314-016-1	314-316-1
18	36	18	100	314-018	314-318	314-018-1	314-318-1	

SQUARE END STRAIGHT FLUTE

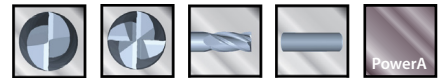

스퀘어 엔드 스트레이트 플루트

2 and 4 Flutes	Coated and Uncoated	Superb performance in hardened materials
2 및 4 플루트	코팅 및 비코팅	경화 재료의 탁월한 성능

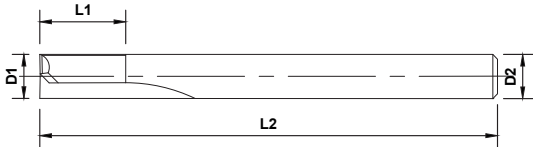

Standard, Series 303

Length Key (K)

Stub Standard Long



K	OD	LOC	SHK	OAL	Uncoated		PowerA	
					2 Flute	4 Flute	2 Flute	4 Flute
	D1	L1	D2	L2				
Standard	3	12	3	38	303-102	303-302	303-102-1	303-302-1
	4	14	4	50	303-104	303-304	303-104-1	303-304-1
	5	16	5	50	303-106	303-306	303-106-1	303-306-1
	6	19	6	63	303-108	303-308	303-108-1	303-308-1
	8	19	8	63	303-110	303-310	303-110-1	303-310-1
	10	22	10	70	303-112	303-312	303-112-1	303-312-1
	12	25	12	75	303-114	303-314	303-114-1	303-314-1
16	32	16	88	303-116	303-316	303-116-1	303-316-1	

BALL END STRAIGHT FLUTE

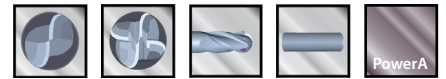

볼 엔드 스트레이트 플루트

2 and 4 Flutes	Coated and Uncoated	Superb performance in hardened materials
2 및 4 플루트	코팅 및 비코팅	경화 재료의 탁월한 성능

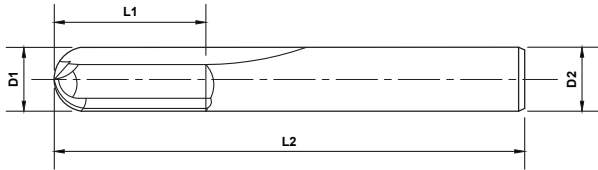

Standard, Series 303

Length Key (K)

■ Stub
 ■ Standard
 ■ Long



K	OD	LOC	SHK	OAL	Uncoated		PowerA	
					2 Flute	4 Flute	2 Flute	4 Flute
	D1	L1	D2	L2				
	3	12	3	38	303-002	303-202	303-002-1	303-202-1
	4	14	4	50	303-004	303-204	303-004-1	303-204-1
	5	16	5	50	303-006	303-206	303-006-1	303-206-1
	6	19	6	63	303-008	303-208	303-008-1	303-208-1
	8	19	8	63	303-010	303-210	303-010-1	303-210-1
	10	22	10	70	303-012	303-212	303-012-1	303-212-1
	12	25	12	75	303-014	303-214	303-014-1	303-214-1
	16	32	16	88	303-016	303-216	303-016-1	303-216-1

SQUARE END MINI MILLS

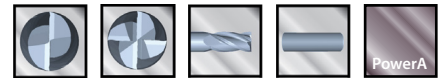

스퀘어 엔드 미니 밀

2 and 4 Flutes	Coated and Uncoated	Rigid, accurate design for micro applications
2 및 4 플루트	코팅 및 비코팅	마이크로 응용 분야용의 철저하고 정확한 설계

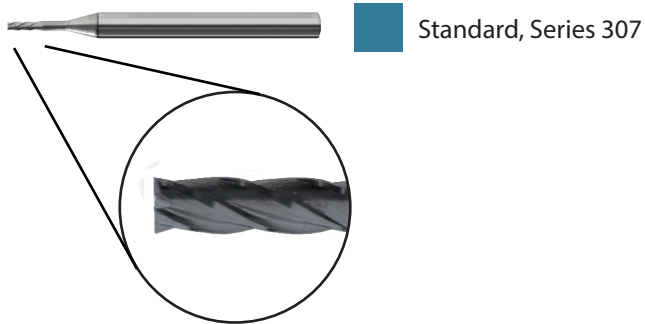
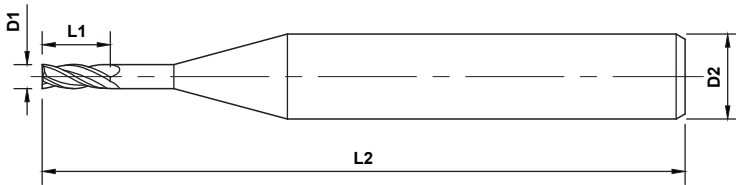

Length Key (K)

■ Stub
 ■ Standard
 ■ Long



K	OD	LOC	SHK	OAL	Uncoated		PowerA	
					2 Flute	4 Flute	2 Flute	4 Flute
	D1	L1	D2	L2				
Standard	0.2	0.6	3	38	307-102	307-502	307-102-1	307-502-1
	0.3	0.9	3	38	307-104	307-504	307-104-1	307-504-1
	0.4	1.2	3	38	307-106	307-506	307-106-1	307-506-1
	0.5	1.5	3	38	307-108	307-508	307-108-1	307-508-1
	0.6	1.8	3	38	307-110	307-510	307-110-1	307-510-1
	0.7	2.1	3	38	307-112	307-512	307-112-1	307-512-1
	0.8	2.4	3	38	307-114	307-514	307-114-1	307-514-1
	0.9	2.7	3	38	307-116	307-516	307-116-1	307-516-1
	1.0	3.0	3	38	309-202	311-202	309-202-1	311-202-1
	1.5	5.0	3	38	309-204	311-204	309-204-1	311-204-1

BALL END MINI MILLS

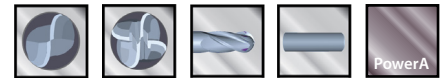

볼 엔드 미니 밀

2 and 4 Flutes	Coated and Uncoated	Rigid, accurate design for micro applications
2 및 4 플루트	코팅 및 비코팅	마이크로 응용 분야용의 철저하고 정확한 설계

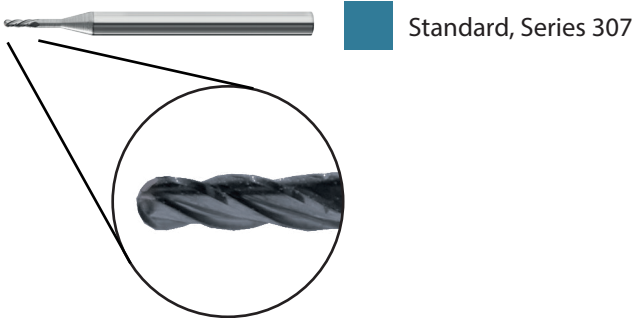
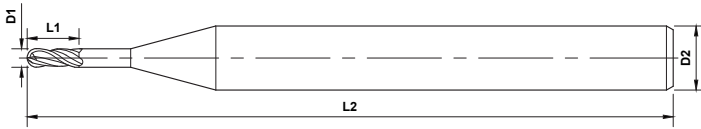

Length Key (K)

■ Stub
 ■ Standard
 ■ Long



K	OD	LOC	SHK	OAL	Uncoated		PowerA	
					2 Flute	4 Flute	2 Flute	4 Flute
	D1	L1	D2	L2				
Standard	0.2	0.6	3	38	307-002	307-402	307-002-1	307-402-1
	0.3	0.9	3	38	307-004	307-404	307-004-1	307-404-1
	0.4	1.2	3	38	307-006	307-406	307-006-1	307-406-1
	0.5	1.5	3	38	307-008	307-408	307-008-1	307-408-1
	0.6	1.8	3	38	307-010	307-410	307-010-1	307-410-1
	0.7	2.1	3	38	307-012	307-412	307-012-1	307-412-1
	0.8	2.4	3	38	307-014	307-414	307-014-1	307-414-1
	0.9	2.7	3	38	307-016	307-416	307-016-1	307-416-1
	1.0	3.0	3	38	309-002	311-002	309-002-1	311-002-1
	1.5	5.0	3	38	309-004	311-004	309-004-1	311-004-1

40° SHORT FLUTE SQUARE

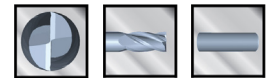

40° 숏 플루트 스퀘어

2 Flute	Uncoated
2 플루트	비코팅

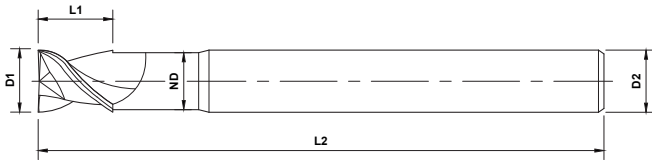

Standard, Series 536

Length Key (K)

■ Stub
 ■ Standard
 ■ Long



K	OD	LOC	SHK	OAL	Reach	Neck	Uncoated
	D1	L1	D2	L2	L3	ND	Part ID
Standard	3	3	6	75	12mm	2.5	536-202
	4	4	6	75	15mm	3.5	536-204
	5	5	6	75	20mm	4.5	536-206
	6	6	6	100	20mm	5.0	536-208
	8	6	8	100	25mm	7.0	536-210
	10	10	10	100	25mm	9.0	536-212
	12	12	12	100	40mm	11.0	536-214
	14	12	14	125	50mm	13.0	536-216
	16	12	16	125	50mm	14.0	536-218
	18	14	18	125	50mm	16.0	536-220
	20	16	20	150	65mm	16.0	536-222

50° SHORT FLUTE BALL

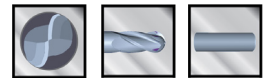

50° 숏 플루트 볼

2 Flute	Uncoated
2 플루트	비코팅



Standard, Series 535

Length Key (K)

■ Stub
 ■ Standard
 ■ Long



K	OD	LOC	SHK	OAL	Uncoated
	D1	L1	D2	L2	Part ID
Standard	2	4	6	75	535-002
	3	5	6	75	535-004
	4	6	6	75	535-006
	5	7	6	75	535-008
	6	8	6	100	535-010
	8	10	8	100	535-012
	10	12	10	100	535-014
	12	16	12	100	535-016
	14	18	14	100	535-018
	16	20	16	125	535-020
	18	22	18	125	535-022
	20	25	20	150	535-024

50° SHORT FLUTE SQUARE REDUCED SHANK

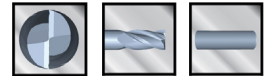

50° 숏 플루트 스퀘어 축소 생크

2 Flute	Short Flute Square Reduced Shank	Uncoated
2 플루트	숏 플루트 스퀘어 축소 생크	비코팅

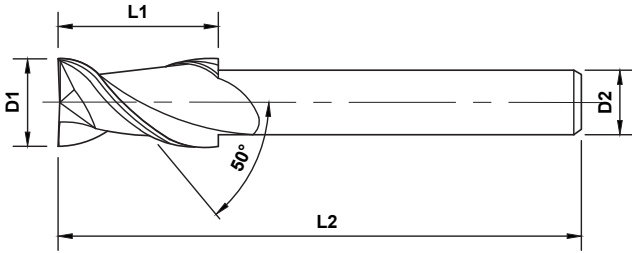

Standard, Series 535

Length Key (K)

■ Stub
 ■ Standard
 ■ Long



K	OD	LOC	SHK	OAL	Part ID
	D1	L1	D2	L2	
Standard	6	6	5	100	535-402
	8	8	7	100	535-404
	10	10	9	100	535-406
	12	12	11	100	535-408
	14	14	12	125	535-410
	16	16	14	125	535-412
	18	18	16	125	535-414
	20	20	18	150	535-416

50° SHORT FLUTE BALL REDUCED SHANK

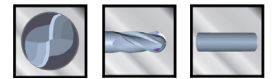

50° 숏 플루트 볼 축소 생크

2 Flute	Short Flute Ball Reduced Shank	Uncoated
2 플루트	숏 플루트 볼 축소 생크	비코팅

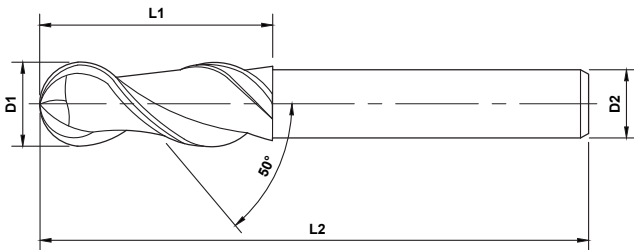

Standard, Series 535

Length Key (K)

■ Stub
 ■ Standard
 ■ Long



K	OD	LOC	SHK	OAL	Part ID
	D1	L1	D2	L2	
K	6	6	5	100	535-202
	8	8	7	100	535-204
	10	10	9	100	535-206
	12	12	11	100	535-208
	14	14	12	125	535-210
	16	16	14	125	535-212
	18	18	16	125	535-214
	20	20	18	150	535-216

SHORT FLUTE NECKED SQUARE ENDMILLS



숏 플루트 넥 스퀘어 엔드밀

2 and 3 Flute	40° Helix	Uncoated
2 및 3 플루트	40° 헬릭스	비코팅

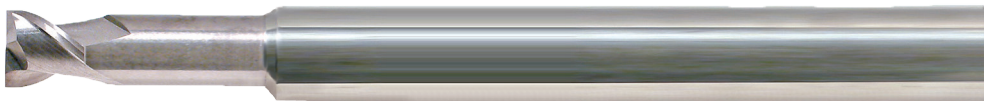
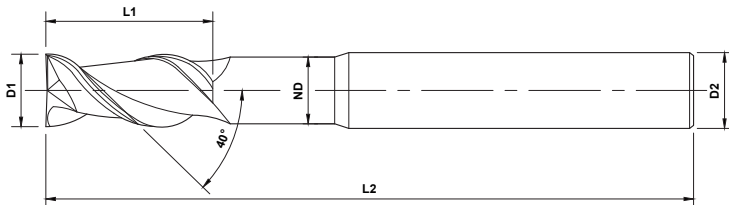

Standard, Series 536

Length Key (K)

■ Stub
 ■ Standard
 ■ Long



OD	LOC	SHK	OAL	Reach	Neck			
D1	L1	D2	L2	L3	ND	Flutes	Part ID	
6	6	6	150	20mm	5	2	536-402	
8	8	8	150	25mm	7	2	536-404	
10	10	10	150	25mm	9	2	536-406	
12	12	12	150	40mm	11	2	536-408	
14	14	14	175	50mm	13	2	536-410	
16	16	16	200	50mm	14	2	536-412	
18	18	18	200	50mm	16	2	536-414	
20	20	20	200	65mm	18	2	536-416	

OD	LOC	SHK	OAL	Reach	Neck			
D1	L1	D2	L2	L3	ND	Flutes	Part ID	
6	6	6	100	20mm	5	3	536-602	
8	6	8	100	25mm	7	3	536-604	
10	10	10	100	25mm	9	3	536-606	
12	12	12	100	40mm	11	3	536-608	
14	12	14	125	50mm	13	3	536-610	
16	12	16	125	50mm	14	3	536-612	
18	14	18	125	50mm	16	3	536-614	
20	16	20	150	65mm	18	3	536-616	

SHORT FLUTE NECKED BALL ENDMILLS

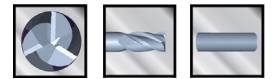

숏 플루트 넥 볼 엔드밀

3 Flute	50° Helix	Uncoated
3 플루트	50° 헬릭스	비코팅

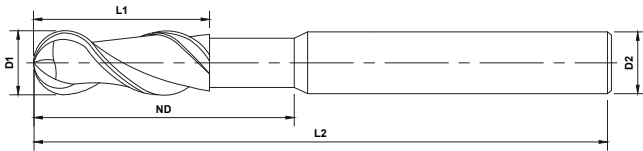

Standard, Series 536

Length Key (K)

■ Stub
 ■ Standard
 ■ Long



OD	LOC	SHK	OAL	Reach	Neck	Part ID
D1	L1	D2	L2	L3	ND	
6	8	6	150	20mm	5	535-602
8	10	8	150	25mm	7	535-604
10	12	10	150	25mm	9	535-606
12	16	12	150	40mm	11	535-608
14	18	14	175	50mm	13	535-610
16	20	16	200	50mm	14	535-612
18	22	18	200	50mm	16	535-614
20	25	20	200	65mm	18	535-616

SHORT FLUTE NECKED CORNER RADIUS

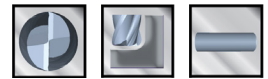

숏 플루트 넥 코너 반경

2 Flute	40° Helix	Uncoated
2 플루트	40° 헬릭스	비코팅

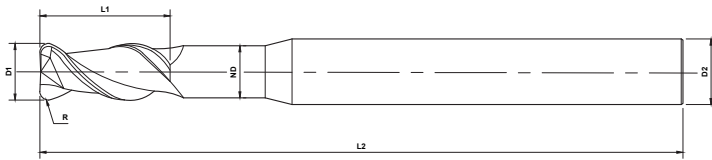

Standard, Series 536

Length Key (K)

■ Stub
 ■ Standard
 ■ Long



K	OD	LOC	SHK	OAL	Reach	Neck	Radius	Part ID
	D1	L1	D2	L2	L3	ND	R	
3		3	6	75	12mm	2.5	0.5	536-002
		3	6	75	12mm	2.5	1.0	536-004
4		4	6	75	15mm	3.5	0.5	536-006
		4	6	75	15mm	3.5	1.0	536-008
5		5	6	75	20mm	4.5	0.5	536-010
		5	6	75	20mm	4.5	1.0	536-012
6		6	6	100	20mm	5	0.5	536-014
		6	6	100	20mm	5	1.0	536-016
		6	6	100	20mm	5	1.5	536-018
		6	6	100	20mm	5	2.0	536-020
		6	6	100	20mm	5	2.5	536-021
		6	6	100	20mm	5	3.0	536-022
8		8	8	100	25mm	7	0.5	536-022
		8	8	100	25mm	7	1.0	536-024
		8	8	100	25mm	7	1.5	536-026
		8	8	100	25mm	7	2.0	536-028
		8	8	100	25mm	7	2.5	536-029
		8	8	100	25mm	7	3.0	536-030

SHORT FLUTE NECKED CORNER RADIUS



숏 플루트 넥 코너 반경



Length Key (K)

■ Stub
 ■ Standard
 ■ Long



K	OD	LOC	SHK	OAL	Reach	Neck	Radius	Part ID
	D1	L1	D2	L2	L3	ND	R	
10	10	10	10	100	25mm	9	0.5	536-032
		10	10	100	25mm	9	1.0	536-034
		10	10	100	25mm	9	1.5	536-036
		10	10	100	25mm	9	2.0	536-038
		10	10	100	25mm	9	2.35	536-039
		10	10	100	25mm	9	3.0	536-040
12	12	12	12	100	40mm	11	0.5	536-042
		12	12	100	40mm	11	1.0	536-044
		12	12	100	40mm	11	1.5	536-046
		12	12	100	40mm	11	2.0	536-048
		12	12	100	40mm	11	2.5	536-049
		12	12	100	40mm	11	3.0	536-050
14	14	14	14	125	50mm	13	0.5	536-052
		14	14	125	50mm	13	1	536-054
16	16	16	16	125	50mm	14	0.5	536-056
		16	16	125	50mm	14	2.0	536-058
		16	16	125	50mm	14	1.5	536-060
		16	16	125	50mm	14	2.0	536-062
		16	16	125	50mm	14	2.5	536-063
		16	16	125	50mm	14	3.0	536-064
		16	16	125	50mm	14	4.0	536-066
20	20	20	20	150	65mm	18	0.5	536-068
		20	20	150	65mm	18	1.0	536-070
		20	20	150	65mm	18	1.5	536-072
		20	20	150	65mm	18	2.0	536-074
		20	20	150	65mm	18	2.5	536-075
		20	20	150	65mm	18	3.0	536-076
		20	20	150	65mm	18	4.0	536-078

EXTRA LONG SQUARE ENDMILL

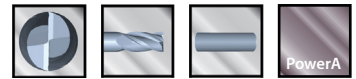

엑스트라 롱 스퀘어 엔드밀

2 Flutes	Extra Long Square	Coated and Uncoated
2 플루트	엑스트라 롱 스퀘어	코팅 및 비코팅

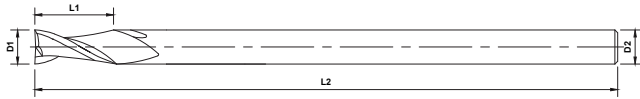

Standard, Series 315

Length Key (K)

■ Stub
 ■ Standard
 ■ Long



	OD	LOC	SHK	OAL	Uncoated	PowerA
	D1	L1	D2	L2	Part ID	Part ID
6		38	6	100	315-202	315-202-1
		75	6	150	315-204	315-204-1
		75	6	200	315-206	315-206-1
		75	8	200	315-208	315-208-1
8		42	8	100	315-210	315-210-1
		75	8	150	315-212	315-212-1
		75	8	200	315-214	315-214-1
		75	10	200	315-216	315-216-1
10		75	10	150	315-218	315-218-1
		75	10	200	315-220	315-220-1
12		75	12	150	315-222	315-222-1
		75	12	200	315-224	315-224-1
14		62	14	125	315-226	315-226-1
		75	14	150	315-228	315-228-1
		75	16	200	315-230	315-230-1
16		75	16	200	315-232	315-232-1
18		75	18	200	315-234	315-234-1
20		75	20	200	315-236	315-236-1

EXTRA LONG BALL ENDMILL

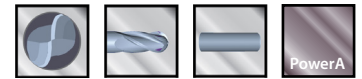

엑스트라 롱 볼 엔드밀

2 Flutes	Extra Long Ball	Coated and Uncoated
2 플루트	엑스트라 롱 볼	코팅 및 비코팅

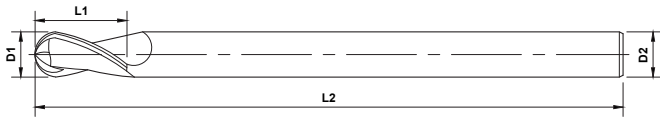

Standard, Series 315

Length Key (K)

■ Stub
 ■ Standard
 ■ Long



	OD	LOC	SHK	OAL	Uncoated	PowerA
	D1	L1	D2	L2	Part ID	Part ID
6		38	6	100	315-002	315-002-1
		75	6	150	315-004	315-004-1
		75	6	200	315-006	315-006-1
		75	8	200	315-008	315-008-1
8		42	8	100	315-010	315-010-1
		75	8	150	315-012	315-012-1
		75	8	200	315-014	315-014-1
		75	10	200	315-016	315-016-1
10		75	10	150	315-018	315-018-1
		75	10	200	315-020	315-020-1
12		75	12	150	315-022	315-022-1
		75	12	200	315-024	315-024-1
14		62	14	125	315-026	315-026-1
		75	14	150	315-028	315-028-1
		75	16	200	315-030	315-030-1
16		75	16	200	315-032	315-032-1
18		75	18	200	315-034	315-034-1
20		75	20	200	315-036	315-036-1

HIGH PERFORMANCE ENDMILLS

고성능 엔드밀

- **V4 and V5**
- **HY5**
- **F45**
- **Mold Mills**
- **TwisterMills**
- **Roughers**
- **AxMills**
- **45° HyperMills**
- **55° AlumaZips**

The customized geometries of our High Performance Endmills make these tool problem solvers for challenging milling operations.

맞춤형 지오메트리 또는 고성능 엔드밀은 까다로운 밀링 작업에서 이러한 공구 문제의 해결사입니다.

The logo for V4 endmills, featuring the text 'V4' in a bold, red, italicized font with a yellow outline, and a stylized yellow and red starburst graphic to the right.The logo for V5 endmills, featuring the text 'V5' in a bold, blue, italicized font with a yellow outline, and a stylized blue and yellow starburst graphic to the right.The logo for F45 endmills, featuring the text 'F45' in a bold, blue, italicized font with a white outline, and a stylized blue and white starburst graphic to the right.The logo for HY5 endmills, featuring the text 'HY5' in a bold, blue, italicized font with a white outline, and a stylized blue and white starburst graphic to the right.The logo for AxMill endmills, featuring the text 'AxMill' in a bold, black, italicized font with a white outline, and a stylized black and white starburst graphic to the right.

LEGENDS

범례

Features

기능

	2 Flutes 2 플루트		Multi-Flute 멀티 플루트		Ball End 볼 엔드
	3 Flutes 3 플루트		Plain Shank 플레인 샹크		Double End Sq. 더블 엔드 스퀘어
	4 Flutes 4 플루트		Corner Radius 코너 반경		Double End Ball 더블 엔드 볼
	6 Flutes 6 플루트		Square End 스퀘어 엔드		Weldon Flat 웰던 플랫

Mastercut's Superior Carbide Blend – A-Gr-SiV (Active Grain Sized Volume)

Our superior tungsten carbide gives you the ability to be **aggressive** when you need to be. Growth inhibitors in our submicron carbide blanks maintain the most consistent grain size available, giving you superior hardness and toughness.

Mastercut의 탁월한 카바이드 혼합 – A-Gr-SiV(액티브 결정 입도 볼륨)

당사의 우수한 텅스텐 카바이드는 귀하가 필요할 때 공격적으로 대응할 수 있는 능력을 제공합니다. 당사의 서브 마이크론 카바이드 블랭크의 성장 억제제는 가장 균일한 결정 입도를 유지하며, 탁월한 경도와 인성을 제공합니다.

Coatings

코팅







	PowerA PowerA (AlTiN)		Uncoated 비코팅		PowerNR PowerNR (nACro)
	PowerT PowerT (TiN)		PowerN PowerN (nACo)		
	PowerZ PowerZ (ZrN)		PowerC PowerC (TiCN)		

TABLE OF CONTENTS - 목차































































	V4, V5, HY5 Tool Features V4, V5, HY5 공구 기능..... 48	   	 
	F45, AxMill, HyperMill and AlumaZip Tool Features F45, 악스밀, 하이퍼밀 및 알루마집 공구 기능..... 49	   	 
	V4 Square Endmills V4 스퀘어 엔드밀..... 50	   	 
	V4 Ball Endmills V4 볼 엔드밀..... 52	   	 
	V4 Corner Radius Endmills V4 코너 반경 엔드밀..... 54	   	 
	V5 Square Endmills V5 스퀘어 엔드밀..... 61	   	 
	V5 Ball Endmills V5 볼 엔드밀..... 62	   	 
	V5 Corner Radius Endmills V5 코너 반경 엔드밀..... 63	   	 
	HY5 Square Endmills HY5 스퀘어 엔드밀..... 64	   	 
	HY5 Corner Radius Endmills HY5 코너 반경 엔드밀..... 65	   	 
	F45 6FL Square Endmills F45 6FL 스퀘어 엔드밀..... 70	   	 
	F45 6FL Corner Radius Endmills F45 6FL 코너 반경 엔드밀..... 71	   	 
	Ball Necked Mold Mills 볼 넥 몰드 밀..... 72	   	 

TABLE OF CONTENTS - 목차

	Ball Necked Extended Reach Mold Mills 볼 넥 연장 길이 몰드 밀	72	     
	3FL 60° Helix Twister Mills 3FL 60° 헬릭스 트위터 밀	73	  
	Roughers - Coarse Pitch 러퍼 - 거친 피치	74	      
	Roughers - Fine Pitch 러퍼 - 미세 피치	75	      
	Roughers - Medium Pitch 러퍼 - 중간 피치	76	      
	AxMills - Square End 악스밀 - 스퀘어 엔드	77	
	AxMills - Corner Radius 악스밀 - 코너 반경	78	
	AxMills - Square End Chipbreaker 악스밀 - 스퀘어 엔드 칩브레이커	79	
	AxMills - Corner Radius Chipbreaker 악스밀 - 코너 반경 칩브레이커	80	
	45° HyperMills 45° 하이퍼밀	81	
	55° AlumaZips 55° 알루마집	81	

HIGH PERFORMANCE TOOL FEATURES

고성능 공구 기능



V4

- The variable 4 flute design interrupts harmonic vibrations to provide improved feeds and speeds, superior finishes and longer tool life
- Ideal for roughing to finishing operations, in both peripheral and slotting functions
- Available in our proprietary and proven PowerA (AlTiN) and the optional nanocomposite PowerNR (nACRo) for difficult-to-machine alloys
- 가변 4 플루트 디자인으로 고조파 진동을 차단하여 향상된 피드 및 속도, 우수한 마감 및 더 긴 공구 수명 제공
- 주변 장치 및 슬로팅 기능 모두에서 러핑에서 마감 작업에 이상적
- 기계 가공이 어려운 합금에 당사의 입증된 독점 PowerA(AlTiN) 및 옵션 나노복합소재 PowerNR(nACRo) 사용 가능



V5

- An impressive combination of variable flutes, a thicker core and eccentrically-ground relief, adding to performance and value
- A strong, stable performer sure to provide chatter-free finishes and aggressive material removal rates
- Available in PowerA (AlTiN) and nanocomposite PowerNR (nACRo) where tool-life demands the very finest coating available
- 5 Flute design
- 가변 플루트, 더욱 두꺼운 코어 및 편심 그라운드 릴리프의 인상적인 조합으로 성능과 가치를 높임
- 강력하고 안정적인 퍼포머로 채터가 없는 마감과 공격적인 재료 제거율 제공
- PowerA(AlTiN) 및 나노복합소재 PowerNR(nACRo)로 공구 수명에서 가장 미세한 코팅을 요구하는 분야에서 사용 가능
- 5 플루트 디자인



HJS

- High performing, broad spectrum semi-finisher/finisher
- Outstanding in stainless steels, high temp alloys, mold steels to 45 Rc
- 5 flute, 45° helix, eccentric grind provides a smooth cutting action with superb chip evacuation
- 20% + increase in productivity versus 4 fluted endmills
- Minimal tool deflection equals better part tolerance
- Stub, standard and long lengths, in square end and corner radius options
- Coated with PowerA (AlTiN)
- 고성능, 광범위한 세미피니셔/피니셔
- 스테인리스강, 고온 합금, 45 Rc 형강에서 우수
- 5 플루트, 45° 헬릭스, 편심 연삭으로 탁월한 칩 배출과 함께 매끄러운 절삭 동작 제공
- 4 플루트 엔드밀 대비 20% 이상 생산성 향상
- 최소 공구 편향이 더 나은 부품 공차와 동일
- 스텝, 표준 및 긴 길이, 스퀘어 및 코너 반경 옵션
- PowerA 코팅(AlTiN)

V4, V5 AND HY5

V4, V5 및 HY5



- 6 flute, high performance finisher providing superb finishes in stainless steels, nickel alloys, Inconels, titanium and more
- 45° degree helix provides superb chip evacuation and excellent shearing action.
- Reduced load pressures and super-stiff design promotes less chatter and the best performance in light finishing applications
- Coated with PowerA (AlTiN)

- 스테인레스강, 니켈 합금, 인코넬, 티타늄 등에서 우수한 마감을 제공하는 6 플루트, 고성능 피니셔
- 45° 헬릭스로 우수한 칩 배출과 뛰어난 전단가공 기능 제공
- 감소된 하중 압력 및 초강성 디자인으로 가벼운 마감 응용 분야에서 chatter를 줄이고 최고의 성능 제공
- PowerA 코팅(AlTiN)



- High performance design for aggressive aluminum milling
- Incorporates a high shear, high rake geometry
- 2 and 3 flute, square end, corner radius and ball end styles
- Available in uncoated and optional PowerZ (Zirconium Nitride) coating
- Chipbreaker option where chip control or spindle horsepower is a concern

- 공격적인 알루미늄 밀링을 위한 고성능 디자인
- 높은 전단가공, 높은 레이크 지오메트리 통합
- 2 및 3 플루트, 스퀘어 엔드, 코너 반경 및 볼 엔드 스타일
- 비코팅 옵션 PowerZ(질화 지르코늄) 코팅에서 사용 가능
- 칩 제어 또는 스펀들 마력이 문제가 되는 칩브레이커 옵션



HyperMill

- Aggressive metal removal rates in aluminum and non-ferrous materials
- 45° helix increases stiffness and improves surface finish
- 2 Flute design

- 알루미늄 및 비철 소재의 공격적인 금속 제거율
- 45° 헬릭스로 강성 증가 및 표면 마감 개선
- 2 플루트 디자인



AlumaZip

- High performance 2 Flute design for high metal removal rates in aluminum and non-ferrous materials
- 55° helix combines a super-stiff profile with a rapid evacuation of chips
- High helix fluting increases contact area, thereby imparting better surface finishes

- 알루미늄 및 비철 소재의 높은 금속 제거율을 위한 고성능 2 플루트 디자인
- 55° 헬릭스로 초강성 프로파일과 신속한 칩 배출 결합
- 높은 헬릭스 플루팅으로 접촉 면적이 증가하여 더 나은 표면 마감 가능

V4 SQUARE ENDMILLS

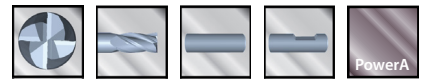

V4 스퀘어 엔드밀

4 Flutes	Coated with or without flat	Unique variable design for faster speeds and feeds
4 플루트	플랫 포함 또는 플랫 없이 코팅	빠른 속도와 피드를 위한 고유 가변 디자인

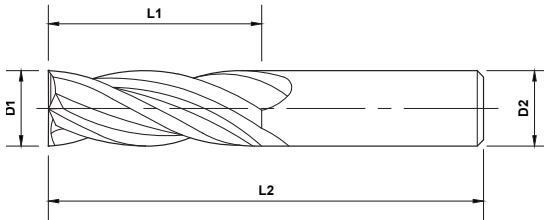

Length Key (K)

■ Stub
 ■ Standard
 ■ Long

Quick Ship Items

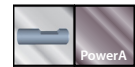

K	OD	LOC	SHK	OAL	PowerA	
					No Flat	With Flat
3	3	12	3	38	500-002-1	500-002W-1
		8	6	57	500-004-1	500-004W-1
		20	3	65	501-002-1	501-002W-1
3.5	3.5	6	3	38	502-002-1	502-002W-1
		7	6	57	500-006-1	500-006W-1
4	4	14	4	50	500-008-1	500-008W-1
		11	6	57	500-010-1	500-010W-1
		20	4	65	501-004-1	501-004W-1
		8	4	50	502-004-1	502-004W-1
4.5	4.5	9	6	57	500-012-1	500-012W-1
		16	5	50	500-014-1	500-014W-1
		13	6	57	500-016-1	500-016W-1
5	5	20	5	75	501-006-1	501-006W-1
		10	5	50	502-006-1	502-006W-1
		19	6	63	500-018-1	500-018W-1
		25	6	75	501-008-1	501-008W-1
6	6	12	6	50	502-008-1	502-008W-1
		13	6	57	502-010-1	502-010W-1

- Flats are not recommended on shank diameters smaller than 8mm.
- 플랫은 8mm보다 작은 샹크 지름에는 권장되지 않습니다.

V4 SQUARE ENDMILLS

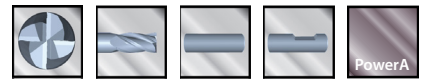

V4 스퀘어 엔드밀

HIGH PERFORMANCE ENDMILLS

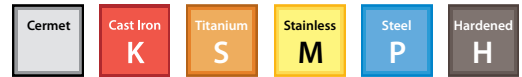

Length Key (K)



Quick Ship Items

K	OD	LOC	SHK	OAL	PowerA	
					No Flat	With Flat
	D1	L1	D2	L2		
8		19	8	63	500-020-1	500-020W-1
		25	8	75	501-010-1	501-010W-1
		12	8	50	502-012-1	502-012W-1
10		22	10	70	500-022-1	500-022W-1
		38	10	100	501-012-1	501-012W-1
		14	10	50	502-014-1	502-014W-1
12		25	12	75	500-024-1	500-024W-1
		50	12	100	501-014-1	501-014W-1
		16	12	63	502-016-1	502-016W-1
14		25	14	88	500-026-1	500-026W-1
		56	14	125	501-016-1	501-016W-1
16		32	16	88	500-028-1	500-028W-1
		56	16	150	501-018-1	501-018W-1
18		36	18	100	500-030-1	500-030W-1
		56	18	150	501-020-1	501-020W-1
20		38	20	100	500-032-1	500-032W-1
		56	20	150	501-022-1	501-022W-1
25		38	25	100	500-034-1	500-034W-1
		70	25	150	501-024-1	501-024W-1

- Flats are not recommended on shank diameters smaller than 8mm.
- 플랫은 8mm보다 작은 샹크 지름에는 권장되지 않습니다.

V4 BALL ENDMILLS

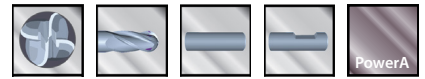

V4 볼 엔드밀

4 Flutes	Coated with or without flat	Unique variable design for faster speeds and feeds
4 플루트	플랫 포함 또는 플랫 없이 코팅	빠른 속도와 피드를 위한 고유 가변 디자인

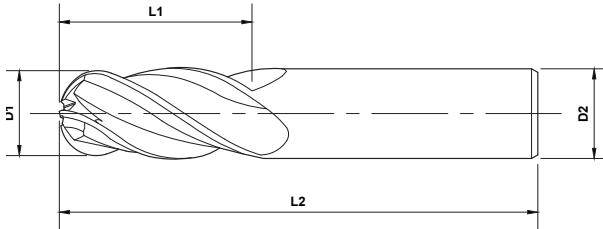

PowerA



Length Key (K)



Quick Ship Items

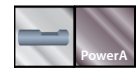
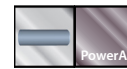

K	OD	LOC	SHK	OAL	PowerA	
					No Flat	With Flat
	D1	L1	D2	L2		
3	3	6	3	38	502-202-1	502-202W-1
		8	6	57	500-204-1	500-204W-1
		12	3	38	500-202-1	500-202W-1
		20	3	65	501-202-1	501-202W-1
3.5	3.5	7	6	57	500-206-1	500-206W-1
		8	4	50	502-204-1	502-204W-1
4	4	11	6	57	500-210-1	500-210W-1
		14	4	50	500-208-1	500-208W-1
		20	4	65	501-204-1	501-204W-1
		9	6	57z	500-212-1	500-212W-1
5	5	10	5	50	502-206-1	502-206W-1
		13	6	57	500-216-1	500-216W-1
		16	5	50	500-214-1	500-214W-1
		25	5	75	501-206-1	501-206W-1
		12	6	50	502-208-1	502-208W-1
6	6	13	6	57	502-210-1	502-210W-1
		19	6	63	500-218-1	500-218W-1
		25	6	75	501-208-1	501-208W-1
		12	6	50	502-208-1	502-208W-1

- Flats are not recommended on shank diameters smaller than 8mm.
- 플랫은 8mm보다 작은 샹크 지름에는 권장되지 않습니다.

V4 BALL ENDMILLS

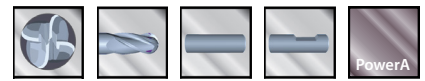

V4 볼 엔드밀

HIGH PERFORMANCE ENDMILLS



Length Key (K)

■ Stub
 ■ Standard
 ■ Long

Quick Ship Items



K	OD	LOC	SHK	OAL	PowerA	
					No Flat	With Flat
	D1	L1	D2	L2		
8		12	8	50	502-212-1	502-212W-1
		19	8	63	500-220-1	500-220W-1
		25	8	75	501-210-1	501-210W-1
10		14	10	50	502-214-1	502-214W-1
		22	10	70	500-222-1	500-222W-1
		38	10	100	501-212-1	501-212W-1
12		16	12	63	502-216-1	502-216W-1
		25	12	75	500-224-1	500-224W-1
		50	12	100	501-214-1	501-214W-1
14		25	14	88	500-226-1	500-226W-1
		56	14	125	501-216-1	501-216W-1
16		32	16	88	500-228-1	500-228W-1
		56	16	150	501-218-1	501-218W-1
18		36	18	100	500-230-1	500-230W-1
		56	18	150	501-220-1	501-220W-1
20		38	20	100	500-232-1	500-232W-1
		56	20	150	501-222-1	501-222W-1
25		38	25	100	500-234-1	500-234W-1
		70	25	150	501-224-1	501-224W-1

- Flats are not recommended on shank diameters smaller than 8mm.
- 플랫은 8mm보다 작은 샹크 지름에는 권장되지 않습니다.

V4 CORNER RADIUS ENDMILLS

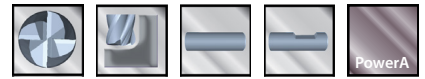

V4 코너 반경 엔드밀

4 Flutes	Coated with or without flat
4 플루트	플랫 포함 또는 플랫 없이 코팅
Unique variable design for faster speeds and feeds	Quiet operation and better finish
빠른 속도와 피드를 위한 고유 가변 디자인	조용한 작동과 더 나은 마무리

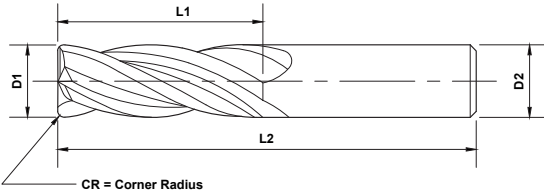

PowerA



Length Key (K)



Quick Ship Items

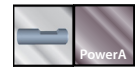
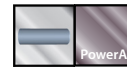

K	OD	LOC	SHK	OAL	Radius	PowerA		
	D1	L1	D2	L2	R	No Flat	With Flat	
3	6	6	3	38	0.25	502-401-1	502-401W-1	
		6	3	38	0.50	502-402-1	502-402W-1	
		6	3	38	0.75	502-403-1	502-403W-1	
		6	3	38	1.00	502-404-1	502-404W-1	
	8	8	6	6	57	0.25	500-410-1	500-410W-1
			8	6	57	0.50	500-411-1	500-411W-1
		12	3	38	0.25	500-400-1	500-400W-1	
			3	38	0.50	500-401-1	500-401W-1	
		20	3	38	0.75	500-402-1	500-402W-1	
				65	0.25	501-400-1	501-400W-1	
			3	65	0.50	501-401-1	501-401W-1	
				65	0.75	501-402-1	501-402W-1	
65	1.00	501-403-1	501-403W-1					
4	8	4	4	50	0.25	502-410-1	502-410W-1	
		4	4	50	0.50	502-411-1	502-411W-1	
		4	4	50	0.75	502-412-1	502-412W-1	
		4	4	50	1.00	502-413-1	502-413W-1	
	11	6	57	0.25	500-430-1	500-430W-1		
			57	0.50	500-431-1	500-431W-1		
		6	57	1.00	500-433-1	500-433W-1		
			50	0.25	500-420-1	500-420W-1		
		14	4	50	0.50	500-421-1	500-421W-1	
				50	0.75	500-422-1	500-422W-1	
			4	50	1.00	500-423-1	500-423W-1	

- Flats are not recommended on shank diameters smaller than 8mm.
- 플랫은 8mm보다 작은 샹크 지름에는 권장되지 않습니다.

V4 CORNER RADIUS ENDMILLS

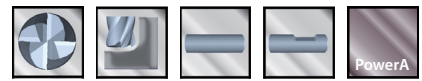

V4 코너 반경 엔드밀



HIGH PERFORMANCE ENDMILLS

Length Key (K)

■ Stub
 ■ Standard
 ■ Long

Quick Ship Items

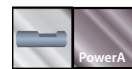

K	OD	LOC	SHK	OAL	Radius	PowerA	
	D1	L1	D2	L2	R	No Flat	With Flat
4	20	4	65	0.25	501-410-1	501-410W-1	
	20	4	65	0.50	501-411-1	501-411W-1	
	20	4	65	0.75	501-412-1	501-412W-1	
	20	4	65	1.00	501-413-1	501-413W-1	
5	10	5	50	0.25	502-420-1	502-420W-1	
	10	5	50	0.50	502-421-1	502-421W-1	
	10	5	50	0.75	502-422-1	502-422W-1	
	10	5	50	1.00	502-423-1	502-423W-1	
	16	5	50	0.25	500-440-1	500-440W-1	
	16	5	50	0.50	500-441-1	500-441W-1	
	16	5	50	0.75	500-442-1	500-442W-1	
	16	5	50	1.00	500-443-1	500-443W-1	
	20	5	75	0.25	501-420-1	501-420W-1	
	20	5	75	0.50	501-422-1	501-422W-1	
	20	5	75	0.75	501-423-1	501-423W-1	
	20	5	75	1.00	501-424-1	501-424W-1	
	13	6	57	0.25	500-450-1	500-450W-1	
	13	6	57	0.50	500-451-1	500-451W-1	
	13	6	57	1.00	500-453-1	500-453W-1	
	6	12	6	50	0.25	502-430-1	502-430W-1
12		6	50	0.50	502-431-1	502-431W-1	
12		6	50	0.75	502-432-1	502-432W-1	
12		6	50	1.00	502-433-1	502-433W-1	
12		6	50	1.25	502-434-1	502-434W-1	
12		6	50	1.50	502-435-1	502-435W-1	
12		6	50	2.00	502-436-1	502-436W-1	
13		6	57	0.25	502-440-1	502-440W-1	
13	6	57	0.50	502-441-1	502-441W-1		

- Flats are not recommended on shank diameters smaller than 8mm.
- 플랫은 8mm보다 작은 샹크 지름에는 권장되지 않습니다.

V4 CORNER RADIUS ENDMILLS

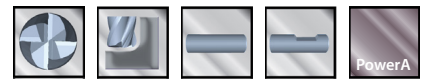

V4 코너 반경 엔드밀



Length Key (K)

■ Stub
 ■ Standard
 ■ Long

Quick Ship Items

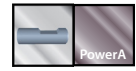

K	OD	LOC	SHK	OAL	Radius	PowerA	
	D1	L1	D2	L2	R	No Flat	With Flat
6	13	6	57	1.00	502-443-1	502-443W-1	
	13	6	57	1.50	502-445-1	502-445W-1	
	13	6	57	2.00	502-446-1	502-446W-1	
	19	6	63	0.25	500-460-1	500-460W-1	
	19	6	63	0.50	500-461-1	500-461W-1	
	19	6	63	0.75	500-462-1	500-462W-1	
	19	6	63	1.00	500-463-1	500-463W-1	
	19	6	63	1.25	500-464-1	500-464W-1	
	19	6	63	1.50	500-465-1	500-465W-1	
	19	6	63	2.00	500-466-1	500-466W-1	
	25	6	75	0.25	501-430-1	501-430W-1	
	25	6	75	0.50	501-431-1	501-431W-1	
	25	6	75	0.75	501-432-1	501-432W-1	
	25	6	75	1.00	501-433-1	501-433W-1	
	25	6	75	1.25	501-434-1	501-434W-1	
	25	6	75	1.50	501-435-1	501-435W-1	
25	6	75	2.00	501-436-1	501-436W-1		
8	12	8	50	0.50	502-451-1	502-451W-1	
	12	8	50	0.75	502-452-1	502-452W-1	
	12	8	50	1.00	502-453-1	502-453W-1	
	12	8	50	1.25	502-454-1	502-454W-1	
	12	8	50	1.50	502-455-1	502-455W-1	
	12	8	50	2.00	502-456-1	502-456W-1	
	12	8	50	3.00	502-457-1	502-457W-1	
	19	8	63	0.50	500-471-1	500-471W-1	
	19	8	63	0.75	500-472-1	500-472W-1	
	19	8	63	1.00	500-473-1	500-473W-1	
	19	8	63	1.25	500-474-1	500-474W-1	
	19	8	63	1.50	500-475-1	500-475W-1	
	19	8	63	2.00	500-476-1	500-476W-1	
	19	8	63	3.00	500-477-1	500-477W-1	
	25	8	75	0.50	501-441-1	501-441W-1	
25	8	75	0.75	501-442-1	501-442W-1		
25	8	75	1.00	501-443-1	501-443W-1		

- Flats are not recommended on shank diameters smaller than 8mm.
- 플랫은 8mm보다 작은 샹크 지름에는 권장되지 않습니다.

V4 CORNER RADIUS ENDMILLS

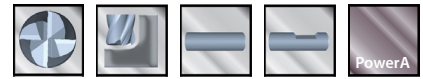

V4 코너 반경 엔드밀



HIGH PERFORMANCE ENDMILLS

Length Key (K)

■ Stub
 ■ Standard
 ■ Long

Quick Ship Items

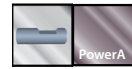
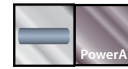

K	OD	LOC	SHK	OAL	Radius	PowerA	
	D1	L1	D2	L2	R	No Flat	With Flat
8	25	8	75	1.25	501-444-1	501-444W-1	
	25	8	75	1.50	501-445-1	501-445W-1	
	25	8	75	2.00	501-446-1	501-446W-1	
	25	8	75	3.00	501-447-1	501-447W-1	
10	14	10	50	0.50	502-461-1	502-461W-1	
	14	10	50	0.75	502-462-1	502-462W-1	
	14	10	50	1.00	502-463-1	502-463W-1	
	14	10	50	1.25	502-464-1	502-464W-1	
	14	10	50	1.50	502-465-1	502-465W-1	
	14	10	50	2.00	502-466-1	502-466W-1	
	14	10	50	3.00	502-467-1	502-467W-1	
	22	10	70	0.50	500-481-1	500-481W-1	
	22	10	70	0.75	500-482-1	500-482W-1	
	22	10	70	1.00	500-483-1	500-483W-1	
	22	10	70	1.25	500-484-1	500-484W-1	
	22	10	70	1.50	500-485-1	500-485W-1	
	22	10	70	2.00	500-486-1	500-486W-1	
	22	10	70	3.00	500-487-1	500-487W-1	
	38	10	100	0.50	501-451-1	501-451W-1	
	38	10	100	0.75	501-452-1	501-452W-1	
38	10	100	1.00	501-453-1	501-453W-1		
38	10	100	1.25	501-454-1	501-454W-1		
38	10	100	1.50	501-455-1	501-455W-1		
38	10	100	2.00	501-456-1	501-456W-1		
38	10	100	3.00	501-457-1	501-457W-1		
12	16	12	63	0.50	502-471-1	502-471W-1	
	16	12	63	0.75	502-472-1	502-472W-1	
	16	12	63	1.00	502-473-1	502-473W-1	
	16	12	63	1.25	502-474-1	502-474W-1	
	16	12	63	1.50	502-475-1	502-475W-1	
	16	12	63	2.00	502-476-1	502-476W-1	
	16	12	63	3.00	502-477-1	502-477W-1	
	16	12	63	4.00	502-478-1	502-478W-1	
	25	12	75	0.50	500-491-1	500-491W-1	

- Flats are not recommended on shank diameters smaller than 8mm.
- 플랫은 8mm보다 작은 샹크 지름에는 권장되지 않습니다.

V4 CORNER RADIUS ENDMILLS

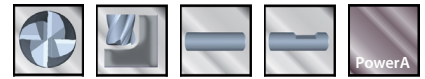

V4 코너 반경 엔드밀



Length Key (K)

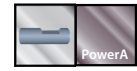

Quick Ship Items

K	OD	LOC	SHK	OAL	Radius	PowerA	
	D1	L1	D2	L2	R	No Flat	With Flat
12	25	12	75	0.75	500-492-1	500-492W-1	500-492W-1
	25	12	75	1.00	500-493-1	500-493W-1	500-493W-1
	25	12	75	1.25	500-494-1	500-494W-1	500-494W-1
	25	12	75	1.50	500-495-1	500-495W-1	500-495W-1
	25	12	75	2.00	500-496-1	500-496W-1	500-496W-1
	25	12	75	3.00	500-497-1	500-497W-1	500-497W-1
	25	12	75	4.00	500-498-1	500-498W-1	500-498W-1
	50	12	100	0.50	501-461-1	501-461W-1	501-461W-1
	50	12	100	0.75	501-462-1	501-462W-1	501-462W-1
	50	12	100	1.00	501-463-1	501-463W-1	501-463W-1
	50	12	100	1.25	501-464-1	501-464W-1	501-464W-1
	50	12	100	1.50	501-465-1	501-465W-1	501-465W-1
	50	12	100	2.00	501-466-1	501-466W-1	501-466W-1
	50	12	100	3.00	501-467-1	501-467W-1	501-467W-1
14	25	14	88	0.50	500-501-1	500-501W-1	500-501W-1
	25	14	88	0.75	500-502-1	500-502W-1	500-502W-1
	25	14	88	1.00	500-503-1	500-503W-1	500-503W-1
	25	14	88	1.50	500-505-1	500-505W-1	500-505W-1
	25	14	88	2.00	500-506-1	500-506W-1	500-506W-1
	25	14	88	3.00	500-507-1	500-507W-1	500-507W-1
	25	14	88	4.00	500-508-1	500-508W-1	500-508W-1
	56	14	125	0.50	501-471-1	501-471W-1	501-471W-1
	56	14	125	0.75	501-472-1	501-472W-1	501-472W-1
	56	14	125	1.00	501-473-1	501-473W-1	501-473W-1
	56	14	125	1.50	501-475-1	501-475W-1	501-475W-1
	56	14	125	2.00	501-476-1	501-476W-1	501-476W-1
	56	14	125	3.00	501-477-1	501-477W-1	501-477W-1
	56	14	125	4.00	501-478-1	501-478W-1	501-478W-1
16	32	16	88	0.50	500-511-1	500-511W-1	500-511W-1
	32	16	88	0.75	500-512-1	500-512W-1	500-512W-1
	32	16	88	1.00	500-513-1	500-513W-1	500-513W-1
	32	16	88	1.50	500-515-1	500-515W-1	500-515W-1
	32	16	88	2.00	500-516-1	500-516W-1	500-516W-1

- Flats are not recommended on shank diameters smaller than 8mm.
- 플랫은 8mm보다 작은 샹크 지름에는 권장되지 않습니다.

V4 CORNER RADIUS ENDMILLS

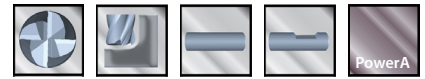

V4 코너 반경 엔드밀



HIGH PERFORMANCE ENDMILLS

Length Key (K)



Quick Ship Items

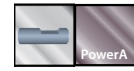
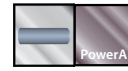

K	OD	LOC	SHK	OAL	Radius	PowerA																																									
						No Flat	With Flat																																								
	D1	L1	D2	L2	R																																										
16	32	16	88	3.00	500-517-1	500-517W-1	500-518-1	500-518W-1																																							
									150	0.50	501-481-1	501-481W-1																																			
													150	0.75	501-482-1	501-482W-1																															
																	150	1.00	501-483-1	501-483W-1																											
																					150	1.50	501-485-1	501-485W-1																							
																									150	2.00	501-486-1	501-486W-1																			
																													150	3.00	501-487-1	501-487W-1															
																																	150	4.00	501-488-1	501-488W-1											
18	36	18	100	0.50	500-521-1	500-521W-1																																									
							100	0.75	500-522-1	500-522W-1																																					
											100	1.00	500-523-1	500-523W-1																																	
															100	1.50	500-525-1	500-525W-1																													
																			100	2.00	500-526-1	500-526W-1																									
																							100	3.00	500-527-1	500-527W-1																					
																											100	4.00	500-528-1	500-528W-1																	
																															150	0.50	501-491-1	501-491W-1													
																																			150	0.75	501-492-1	501-492W-1									
																																							150	1.00	501-493-1	501-493W-1					
																																											150	1.50	501-495-1	501-495W-1	
																																															150
150	3.00	501-497-1	501-497W-1																																												
				150	4.00	501-498-1	501-498W-1																																								
								20	38	20	100	0.50	500-531-1	500-531W-1																																	
															100	0.75	500-532-1	500-532W-1																													
																			100	1.00	500-533-1	500-533W-1																									
																							100	1.50	500-535-1	500-535W-1																					
																											100	2.00	500-536-1	500-536W-1																	
																															100	3.00	500-537-1	500-537W-1													
																																			100	4.00	500-538-1	500-538W-1									
																																							100	5.00	500-539-1	500-539W-1					
																																											150	20	0.50	501-501-1	
																																															150
150	1.00	501-503-1	501-503W-1																																												

- Flats are not recommended on shank diameters smaller than 8mm.
- 플랫은 8mm보다 작은 샹크 지름에는 권장되지 않습니다.

V4 CORNER RADIUS ENDMILLS

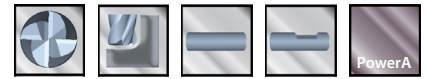

V4 코너 반경 엔드밀



Length Key (K)

Stub
 Standard
 Long

Quick Ship Items

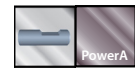

K	OD	LOC	SHK	OAL	Radius	PowerA	
	D1	L1	D2	L2	R	No Flat	With Flat
20		56	20	150	1.50	501-505-1	501-505W-1
		56	20	150	2.00	501-506-1	501-506W-1
		56	20	150	3.00	501-507-1	501-507W-1
		56	20	150	4.00	501-508-1	501-508W-1
		56	20	150	5.00	501-509-1	501-509W-1
25		38	25	100	0.50	500-541-1	500-541W-1
		38	25	100	0.75	500-542-1	500-542W-1
		38	25	100	1.00	500-543-1	500-543W-1
		38	25	100	1.50	500-545-1	500-545W-1
		38	25	100	2.00	500-546-1	500-546W-1
		38	25	100	3.00	500-547-1	500-547W-1
		38	25	100	4.00	500-548-1	500-548W-1
		38	25	100	5.00	500-549-1	500-549W-1
		70	25	150	0.50	501-511-1	501-511W-1
		70	25	150	0.75	501-512-1	501-512W-1
		70	25	150	1.00	501-513-1	501-513W-1
		70	25	150	1.50	501-515-1	501-515W-1
		70	25	150	2.00	501-516-1	501-516W-1
		70	25	150	3.00	501-517-1	501-517W-1
		70	25	150	4.00	501-518-1	501-518W-1
	70	25	150	5.00	501-519-1	501-519W-1	

- Flats are not recommended on shank diameters smaller than 8mm.
- 플랫은 8mm보다 작은 샹크 지름에는 권장되지 않습니다.

V5 SQUARE ENDMILLS

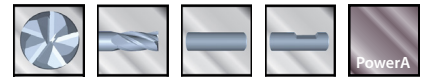

V5 스퀘어 엔드밀

HIGH PERFORMANCE ENDMILLS

5 Flutes 5 플루트	Coated with or without flat 플랫 포함 또는 플랫 없이 코팅	Quiet operation and better finish 조용한 작동과 더 나은 마무리
-------------------	--	---

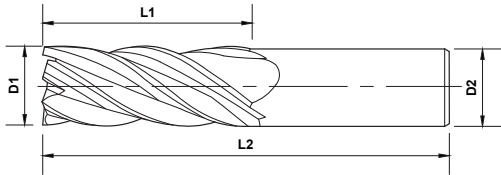

PowerA



Length Key (K)

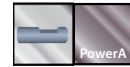

Quick Ship Items

	OD	LOC	SHK	OAL	PowerA	
	D1	L1	D2	L2	No Flat	With Flat
8		12	8	50	510-010-1	510-010W-1
		19	8	63	508-010-1	508-010W-1
		25	8	75	509-010-1	509-010W-1
10		14	10	50	510-012-1	510-012W-1
		22	10	70	508-012-1	508-012W-1
		38	10	100	509-012-1	509-012W-1
12		16	12	63	510-014-1	510-014W-1
		25	12	75	508-014-1	508-014W-1
		50	12	100	509-014-1	509-014W-1
14		25	14	88	508-016-1	508-016W-1
		56	14	125	509-016-1	509-016W-1
		32	16	88	508-018-1	508-018W-1
16		56	16	150	509-018-1	509-018W-1
		36	18	100	508-020-1	508-020W-1
		56	18	150	509-020-1	509-020W-1
18		38	20	100	508-022-1	508-022W-1
		56	20	150	509-022-1	509-022W-1
		38	25	100	508-024-1	508-024W-1
25		70	25	150	509-024-1	509-024W-1

- Flats are not recommended on shank diameters smaller than 8mm.
- 플랫은 8mm보다 작은 샹크 지름에는 권장되지 않습니다.

V5 BALL ENDMILLS

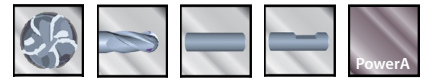

V5 볼 엔드밀

5 Flutes 5 플루트	Coated with or without flat 플랫 포함 또는 플랫 없이 코팅	Quiet operation and better finish 조용한 작동과 더 나은 마무리
-------------------	--	---

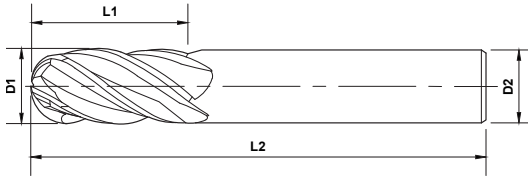

PowerA



Length Key (K)



Quick Ship Items

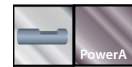

	OD	LOC	SHK	OAL	PowerA	
					No Flat	With Flat
	D1	L1	D2	L2		
8		12	8	50	510-210-1	510-210W-1
		19	8	63	508-210-1	508-210W-1
		25	8	75	509-210-1	509-210W-1
10		14	10	50	510-212-1	510-212W-1
		22	10	70	508-212-1	508-212W-1
		38	10	100	509-212-1	509-212W-1
12		16	12	63	510-214-1	510-214W-1
		25	12	75	508-214-1	508-214W-1
		50	12	100	509-214-1	509-214W-1
14		25	14	88	508-216-1	508-216W-1
		56	14	125	509-216-1	509-216W-1
16		32	16	88	508-218-1	508-218W-1
		56	16	150	509-218-1	509-218W-1
18		36	18	100	508-220-1	508-220W-1
		56	18	150	509-220-1	509-220W-1
20		38	20	100	508-222-1	508-222W-1
		56	20	150	509-222-1	509-222W-1
25		38	25	100	508-224-1	508-224W-1
		70	25	150	509-224-1	509-224W-1

- Flats are not recommended on shank diameters smaller than 8mm.
- 플랫은 8mm보다 작은 샹크 지름에는 권장되지 않습니다.

V5 CORNER RADIUS ENDMILLS

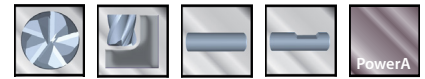

V5 코너 반경 엔드밀

HIGH PERFORMANCE ENDMILLS

5 Flutes	Coated with or without flat	Quiet operation and better finish
5 플루트	플랫 포함 또는 플랫 없이 코팅	조용한 작동과 더 나은 마무리

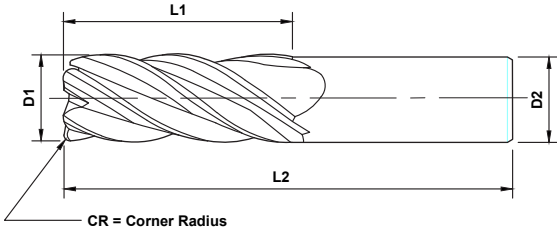

PowerA



Length Key (K)



Quick Ship Items

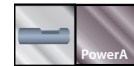

	OD	LOC	SHK	OAL	Radius	PowerA	
	D1	L1	D2	L2	R	No Flat	With Flat
6	6	15	6	75	0.50	509-431-1	509-431W-1
		12	8	50	0.50	510-441-1	510-441W-1
8	8	19	8	63	0.50	508-441-1	508-441W-1
		25	8	75	0.50	509-441-1	509-441W-1
10	10	14	10	50	0.50	510-451-1	510-451W-1
		22	10	70	0.50	508-451-1	508-451W-1
		38	10	100	0.50	509-451-1	509-451W-1
12	12	16	12	63	0.75	510-462-1	510-462W-1
		25	12	75	0.75	508-462-1	508-462W-1
		50	12	100	0.75	509-462-1	509-462W-1
14	14	25	14	88	0.75	508-472-1	508-472W-1
		56	14	125	0.75	509-472-1	509-472W-1
16	16	32	16	88	0.75	508-482-1	508-482W-1
		56	16	150	0.75	509-482-1	509-482W-1
18	18	36	18	100	0.75	508-492-1	508-492W-1
		56	18	150	0.75	509-492-1	509-492W-1
20	20	38	20	100	0.75	508-502-1	508-502W-1
		56	20	150	0.75	509-502-1	509-502W-1
25	25	38	25	100	0.75	508-512-1	508-512W-1
		70	25	150	0.75	509-512-1	509-512W-1

- Flats are not recommended on shank diameters smaller than 8mm.
- 플랫은 8mm보다 작은 샹크 지름에는 권장되지 않습니다.

HY5 SQUARE ENDMILLS

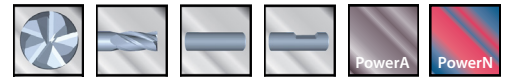

HY5 스퀘어 엔드밀

5 Flutes	Coated with or without flat	Unique 5 flute design for faster speeds and feeds
5 플루트	플랫 포함 또는 플랫 없이 코팅	빠른 속도와 피드를 위한 고유 5 플루트 디자인

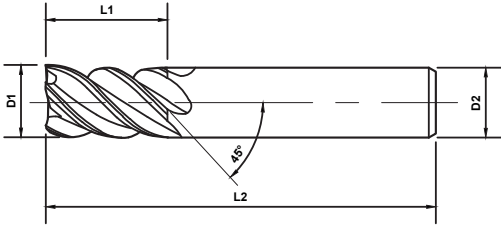

Length Key (K)



Quick Ship Items

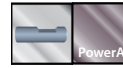
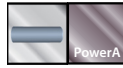

OD	LOC	SHK	OAL	PowerA		PowerNR	
				No Flat	With Flat	No Flat	With Flat
3	6	3	38	547-002-1	547-002W-1	547-002-8	547-002W-8
	12	3	38	545-002-1	545-002W-1	545-002-8	545-002W-8
	20	3	65	546-002-1	546-002W-1	546-002-8	546-002W-8
4	8	4	50	547-004-1	547-004W-1	547-004-8	547-004W-8
	14	4	50	545-008-1	545-008W-1	545-008-8	545-008W-8
	20	4	65	546-004-1	546-004W-1	546-004-8	546-004W-8
5	10	5	50	547-006-1	547-006W-1	547-006-8	547-006W-8
	16	5	50	545-014-1	545-014W-1	545-014-8	545-014W-8
	20	5	75	546-006-1	546-006W-1	546-006-8	546-006W-8
6	12	6	50	547-008-1	547-008W-1	547-008-8	547-008W-8
	19	6	63	545-018-1	545-018W-1	545-018-8	545-018W-8
	25	6	75	546-008-1	546-008W-1	546-008-8	546-008W-8
8	12	8	50	547-012-1	547-012W-1	547-012-8	547-012W-8
	19	8	63	545-020-1	545-020W-1	545-020-8	545-020W-8
	25	8	75	546-010-1	546-010W-1	546-010-8	546-010W-8
10	14	10	50	547-014-1	547-014W-1	547-014-8	547-014W-8
	22	10	70	545-022-1	545-022W-1	545-022-8	545-022W-8
	38	10	100	546-012-1	546-012W-1	546-012-8	546-012W-8
12	16	12	63	547-016-1	547-016W-1	547-016-8	547-016W-8
	25	12	75	545-024-1	545-024W-1	545-024-8	545-024W-8
	50	12	100	546-014-1	546-014W-1	546-014-8	546-014W-8
14	25	14	88	545-026-1	545-026W-1	545-026-8	545-026W-8
	56	14	125	546-016-1	546-016W-1	546-016-8	546-016W-8
16	32	16	88	545-028-1	545-028W-1	545-028-8	545-028W-8
	56	16	150	546-018-1	546-018W-1	546-018-8	546-018W-8
18	36	18	100	545-030-1	545-030W-1	545-030-8	545-030W-8
	56	18	150	546-020-1	546-020W-1	546-020-8	546-020W-8
20	38	20	100	545-032-1	545-032W-1	545-032-8	545-032W-8
	56	20	150	546-022-1	546-022W-1	546-022-8	546-022W-8
25	38	25	100	545-034-1	545-034W-1	545-034-8	545-034W-8
	70	25	150	546-024-1	546-024W-1	546-024-8	546-024W-8

HY5 CORNER RADIUS ENDMILLS

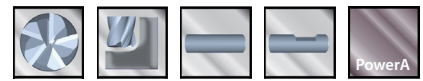

HY5 코너 반경 엔드밀

HIGH PERFORMANCE ENDMILLS

5 Flutes	Coated with or without flat	Unique 5 flute design for faster speeds and feeds
5 플루트	플랫 포함 또는 플랫 없이 코팅	빠른 속도와 피드를 위한 고유 5 플루트 디자인

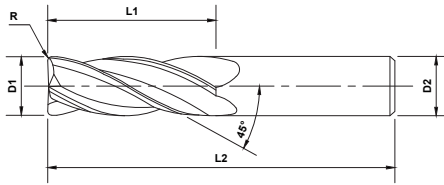

PowerA



Length Key (K)

Stub
 Standard
 Long

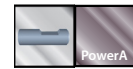

	OD	LOC	SHK	OAL	Radius	PowerA	
	D1	L1	D2	L2	R	No Flat	With Flat
3	6	3	3	38	0.25	547-401-1	547-401W-1
					0.50	547-402-1	547-402W-1
					0.75	547-403-1	547-403W-1
					1.00	547-404-1	547-404W-1
	12	3	3	38	0.25	545-400-1	545-400W-1
					0.50	545-401-1	545-401W-1
					0.75	545-402-1	545-402W-1
					1.00	545-403-1	545-403W-1
	20	3	3	65	0.25	546-400-1	546-400W-1
					0.50	546-401-1	546-401W-1
					0.75	546-402-1	546-402W-1
					1.00	546-403-1	546-403W-1
4	8	4	4	50	0.25	547-410-1	547-410W-1
					0.50	547-411-1	547-411W-1
					0.75	547-412-1	547-412W-1
					1.00	547-413-1	547-413W-1
	14	4	4	50	0.25	545-420-1	545-420W-1
					0.50	545-421-1	545-421W-1
					0.75	545-422-1	545-422W-1
					1.00	545-423-1	545-423W-1
	20	4	4	65	0.25	546-410-1	546-410W-1
					0.50	546-411-1	546-411W-1
					0.75	546-412-1	546-412W-1
					1.00	546-413-1	546-413W-1
5	10	5	50	0.25	547-420-1	547-420W-1	
				0.50	547-421-1	547-421W-1	
				0.75	547-422-1	547-422W-1	

- Flats are not recommended on shank diameters smaller than 8mm.
- 플랫은 8mm보다 작은 샹크 지름에는 권장되지 않습니다.

HY5 CORNER RADIUS ENDMILLS

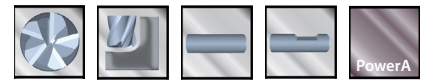

HY5 코너 반경 엔드밀



OD	LOC	SHK	OAL	Radius	PowerA	
					No Flat	With Flat
D1	L1	D2	L2	R		
5	10	5	50	1.00	547-423-1	547-423W-1
	16	5	50	0.25	545-440-1	545-440W-1
	16	5	50	0.50	545-441-1	545-441W-1
	16	5	50	0.75	545-442-1	545-442W-1
	16	5	50	1.00	545-443-1	545-443W-1
	20	5	75	0.25	546-420-1	546-420W-1
	20	5	75	0.50	546-422-1	546-422W-1
	20	5	75	0.75	546-423-1	546-423W-1
	20	5	75	1.00	546-424-1	546-424W-1
6	12	6	50	0.25	547-430-1	547-430W-1
	12	6	50	0.50	547-431-1	547-431W-1
	12	6	50	0.75	547-432-1	547-432W-1
	12	6	50	1.00	547-433-1	547-433W-1
	12	6	50	1.25	547-434-1	547-434W-1
	12	6	50	1.50	547-435-1	547-435W-1
	12	6	50	2.00	547-436-1	547-436W-1
	19	6	63	0.25	545-460-1	545-460W-1
	19	6	63	0.50	545-461-1	545-461W-1
	19	6	63	0.75	545-462-1	545-462W-1
	19	6	63	1.00	545-463-1	545-463W-1
	19	6	63	1.25	545-464-1	545-464W-1
	19	6	63	1.50	545-465-1	545-465W-1
	19	6	63	2.00	545-466-1	545-466W-1
	25	6	75	0.25	546-430-1	546-430W-1
	25	6	75	0.50	546-431-1	546-431W-1
	25	6	75	0.75	546-432-1	546-432W-1
	25	6	75	1.00	546-433-1	546-433W-1
	25	6	75	1.25	546-434-1	546-434W-1
	25	6	75	1.50	546-435-1	546-435W-1
25	6	75	2.00	546-436-1	546-436W-1	
8	12	8	50	0.50	547-451-1	547-451W-1
	12	8	50	0.75	547-452-1	547-452W-1
	12	8	50	1.00	547-453-1	547-453W-1
	12	8	50	1.25	547-454-1	547-454W-1
	12	8	50	1.50	547-455-1	547-455W-1
	12	8	50	2.00	547-456-1	547-456W-1
	12	8	50	3.00	547-457-1	547-457W-1
	19	8	63	0.50	545-471-1	545-471W-1
	19	8	63	0.75	545-472-1	545-472W-1
	19	8	63	1.00	545-473-1	545-473W-1
	19	8	63	1.25	545-474-1	545-474W-1
	19	8	63	1.50	545-475-1	545-475W-1
	19	8	63	2.00	545-476-1	545-476W-1
	19	8	63	3.00	545-477-1	545-477W-1

- Flats are not recommended on shank diameters smaller than 8mm.
- 플랫은 8mm보다 작은 샹크 지름에는 권장되지 않습니다.

HY5 CORNER RADIUS ENDMILLS

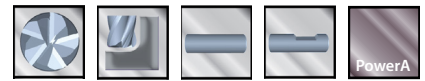

HY5 코너 반경 엔드밀



HIGH PERFORMANCE ENDMILLS

OD	LOC	SHK	OAL	Radius	PowerA		
					No Flat	With Flat	
8	L1	D2	L2	R			
		25	8	75	0.50	546-441-1	546-441W-1
		25	8	75	0.75	546-442-1	546-442W-1
		25	8	75	1.00	546-443-1	546-443W-1
		25	8	75	1.25	546-444-1	546-444W-1
		25	8	75	1.50	546-445-1	546-445W-1
		25	8	75	2.00	546-446-1	546-446W-1
10	L1	D2	L2	R			
		14	10	50	0.50	547-461-1	547-461W-1
		14	10	50	0.75	547-462-1	547-462W-1
		14	10	50	1.00	547-463-1	547-463W-1
		14	10	50	1.25	547-464-1	547-464W-1
		14	10	50	1.50	547-465-1	547-465W-1
		14	10	50	2.00	547-466-1	547-466W-1
		14	10	50	3.00	547-467-1	547-467W-1
		22	10	70	0.50	545-481-1	545-481W-1
		22	10	70	0.75	545-482-1	545-482W-1
		22	10	70	1.00	545-483-1	545-483W-1
		22	10	70	1.25	545-484-1	545-484W-1
		22	10	70	1.50	545-485-1	545-485W-1
		22	10	70	2.00	545-486-1	545-486W-1
		22	10	70	3.00	545-487-1	545-487W-1
		38	10	100	0.50	546-451-1	546-451W-1
		38	10	100	0.75	546-452-1	546-452W-1
		38	10	100	1.00	546-453-1	546-453W-1
		38	10	100	1.25	546-454-1	546-454W-1
		38	10	100	1.50	546-455-1	546-455W-1
38	10	100	2.00	546-456-1	546-456W-1		
38	10	100	3.00	546-457-1	546-457W-1		
12	L1	D2	L2	R			
		16	12	63	0.50	547-471-1	547-471W-1
		16	12	63	0.75	547-472-1	547-472W-1
		16	12	63	1.00	547-473-1	547-473W-1
		16	12	63	1.25	547-474-1	547-474W-1
		16	12	63	1.50	547-475-1	547-475W-1
		16	12	63	2.00	547-476-1	547-476W-1
		16	12	63	3.00	547-477-1	547-477W-1
		16	12	63	4.00	547-478-1	547-478W-1
		25	12	75	0.50	545-491-1	545-491W-1
		25	12	75	0.75	545-492-1	545-492W-1
		25	12	75	1.00	545-493-1	545-493W-1
		25	12	75	1.25	545-494-1	545-494W-1
		25	12	75	1.50	545-495-1	545-495W-1
		25	12	75	2.00	545-496-1	545-496W-1
		25	12	75	3.00	545-497-1	545-497W-1
		25	12	75	4.00	545-498-1	545-498W-1

- Flats are not recommended on shank diameters smaller than 8mm.
- 플랫은 8mm보다 작은 샹크 지름에는 권장되지 않습니다.



HY5 CORNER RADIUS ENDMILLS

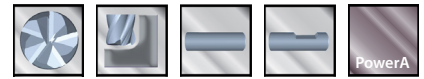

HY5 코너 반경 엔드밀



OD	LOC	SHK	OAL	Radius	PowerA		
					No Flat	With Flat	
12	L1	D2	L2	R			
		50	12	100	0.50	546-461-1	546-461W-1
		50	12	100	0.75	546-462-1	546-462W-1
		50	12	100	1.00	546-463-1	546-463W-1
		50	12	100	1.25	546-464-1	546-464W-1
		50	12	100	1.50	546-465-1	546-465W-1
		50	12	100	2.00	546-466-1	546-466W-1
		50	12	100	3.00	546-467-1	546-467W-1
14	L1	25	14	88	0.50	545-501-1	545-501W-1
		25	14	88	0.75	545-502-1	545-502W-1
		25	14	88	1.00	545-503-1	545-503W-1
		25	14	88	1.50	545-505-1	545-505W-1
		25	14	88	2.00	545-506-1	545-506W-1
		25	14	88	3.00	545-507-1	545-507W-1
		25	14	88	4.00	545-508-1	545-508W-1
		56	14	125	0.50	546-471-1	546-471W-1
		56	14	125	0.75	546-472-1	546-472W-1
		56	14	125	1.00	546-473-1	546-473W-1
		56	14	125	1.50	546-475-1	546-475W-1
		56	14	125	2.00	546-476-1	546-476W-1
		56	14	125	3.00	546-477-1	546-477W-1
		56	14	125	4.00	546-478-1	546-478W-1
16	L1	32	16	88	0.50	545-511-1	545-511W-1
		32	16	88	0.75	545-512-1	545-512W-1
		32	16	88	1.00	545-513-1	545-513W-1
		32	16	88	1.50	545-515-1	545-515W-1
		32	16	88	2.00	545-516-1	545-516W-1
		32	16	88	3.00	545-517-1	545-517W-1
		32	16	88	4.00	545-518-1	545-518W-1
		56	16	150	0.50	546-481-1	546-481W-1
		56	16	150	0.75	546-482-1	546-482W-1
		56	16	150	1.00	546-483-1	546-483W-1
		56	16	150	1.50	546-485-1	546-485W-1
		56	16	150	2.00	546-486-1	546-486W-1
		56	16	150	3.00	546-487-1	546-487W-1
		56	16	150	4.00	546-488-1	546-488W-1
18	L1	36	18	100	0.50	545-521-1	545-521W-1
		36	18	100	0.75	545-522-1	545-522W-1
		36	18	100	1.00	545-523-1	545-523W-1
		36	18	100	1.50	545-525-1	545-525W-1
		36	18	100	2.00	545-526-1	545-526W-1
		36	18	100	3.00	545-527-1	545-527W-1
		36	18	100	4.00	545-528-1	545-528W-1
		56	18	150	0.50	546-491-1	546-491W-1

- Flats are not recommended on shank diameters smaller than 8mm.
- 플랫은 8mm보다 작은 샹크 지름에는 권장되지 않습니다.

HY5 CORNER RADIUS ENDMILLS

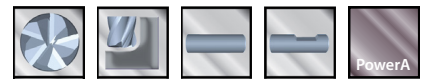

HY5 코너 반경 엔드밀



HIGH PERFORMANCE ENDMILLS



OD	LOC	SHK	OAL	Radius	PowerA	
					No Flat	With Flat
D1	L1	D2	L2	R		
18	56	18	150	0.75	546-492-1	546-492W-1
	56	18	150	1.00	546-493-1	546-493W-1
	56	18	150	1.50	546-495-1	546-495W-1
	56	18	150	2.00	546-496-1	546-496W-1
	56	18	150	3.00	546-497-1	546-497W-1
	56	18	150	4.00	546-498-1	546-498W-1
20	38	20	100	0.50	545-531-1	545-531W-1
	38	20	100	0.75	545-532-1	545-532W-1
	38	20	100	1.00	545-533-1	545-533W-1
	38	20	100	1.50	545-535-1	545-535W-1
	38	20	100	2.00	545-536-1	545-536W-1
	38	20	100	3.00	545-537-1	545-537W-1
	38	20	100	4.00	545-538-1	545-538W-1
	38	20	100	5.00	545-539-1	545-539W-1
	56	20	150	0.50	546-501-1	546-501W-1
	56	20	150	0.75	546-502-1	546-502W-1
	56	20	150	1.00	546-503-1	546-503W-1
	56	20	150	1.50	546-505-1	546-505W-1
	56	20	150	2.00	546-506-1	546-506W-1
	56	20	150	3.00	546-507-1	546-507W-1
56	20	150	4.00	546-508-1	546-508W-1	
56	20	150	5.00	546-509-1	546-509W-1	
25	38	25	100	0.50	545-541-1	545-541W-1
	38	25	100	0.75	545-542-1	545-542W-1
	38	25	100	1.00	545-543-1	545-543W-1
	38	25	100	1.50	545-545-1	545-545W-1
	38	25	100	2.00	545-546-1	545-546W-1
	38	25	100	3.00	545-547-1	545-547W-1
	38	25	100	4.00	545-548-1	545-548W-1
	38	25	100	5.00	545-549-1	545-549W-1
	70	25	150	0.50	546-511-1	546-511W-1
	70	25	150	0.75	546-512-1	546-512W-1
	70	25	150	1.00	546-513-1	546-513W-1
	70	25	150	1.50	546-515-1	546-515W-1
	70	25	150	2.00	546-516-1	546-516W-1
	70	25	150	3.00	546-517-1	546-517W-1
70	25	150	4.00	546-518-1	546-518W-1	
70	25	150	5.00	546-519-1	546-519W-1	

- Flats are not recommended on shank diameters smaller than 8mm.
- 플랫은 8mm보다 작은 샹크 지름에는 권장되지 않습니다.

F45 6FL SQUARE ENDMILLS

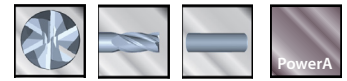

F45 6FL 스퀘어 엔드밀

6 Flutes	coated and uncoated	45° 6 flute design for superior finish
6 플루트	코팅 및 비코팅	탁월한 마감을 위해 설계된 45° 6 플루트

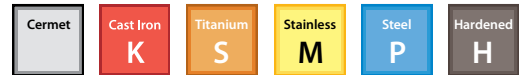
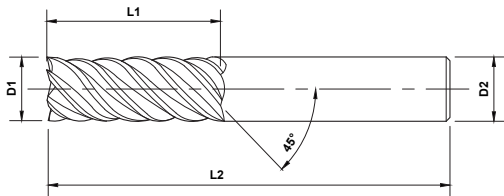

Uncoated



PowerA

Length Key (K)



Quick Ship Items



OD	LOC	SHK	OAL	Uncoated	PowerA
D1	L1	D2	L2		
5	16	5	50	511-002	511-002-1
6	19	6	63	511-004	511-004-1
7	19	8	63	511-006	511-006-1
8	21	8	63	511-008	511-008-1
9	22	10	70	511-010	511-010-1
10	25	10	70	511-012	511-012-1
11	25	11	70	511-014	511-014-1
12	25	12	75	511-016	511-016-1
14	30	14	88	511-018	511-018-1
16	32	16	88	511-020	511-020-1
18	35	18	100	511-022	511-022-1
20	38	20	100	511-024	511-024-1
22	38	22	100	511-026	511-026-1
25	38	25	100	511-028	511-028-1

F45 6FL CORNER RADIUS ENDMILLS

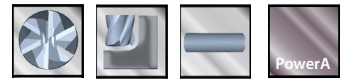

F45 6FL 코너 반경 엔드밀

HIGH PERFORMANCE ENDMILLS

6 Flutes	coated and uncoated	45° 6 flute design for superior finish
6 플루트	코팅 및 비코팅	탁월한 마감을 위해 설계된 45° 6 플루트

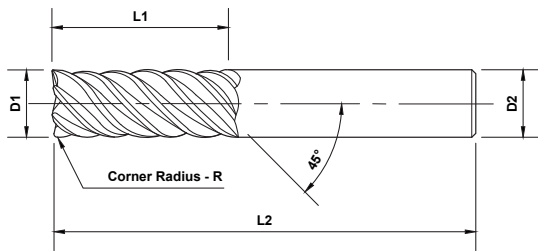

Uncoated



PowerA

Length Key (K)

■ Stub
 ■ Standard
 ■ Long



OD	LOC	SHK	OAL	Radius	Uncoated	PowerA
D1	L1	D2	L2	R		
5	16	5	50	0.25	511-200	511-200-1
6	19	6	63	0.25	511-210	511-210-1
7	19	8	63	0.25	511-220	511-220-1
8	21	8	63	0.25	511-230	511-230-1
9	22	10	70	0.50	511-241	511-241-1
10	25	10	70	0.50	511-251	511-251-1
11	25	11	70	0.50	511-261	511-261-1
12	25	12	75	0.50	511-271	511-271-1
14	30	14	88	0.50	511-281	511-281-1
16	32	16	88	0.50	511-291	511-291-1
18	35	18	100	1.00	511-303	511-303-1
20	38	20	100	1.00	511-313	511-313-1
22	38	22	100	1.00	511-323	511-323-1
25	38	25	100	1.25	511-334	511-334-1

MOLD MILLS BALL NECKED

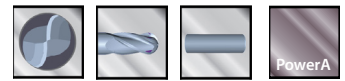

몰드 밀 볼 넥

2 Flutes	coated and uncoated	Superb quality for mold and die operation
2 플루트	코팅 및 비코팅	몰드 및 다이 작업을 위한 최고의 품질

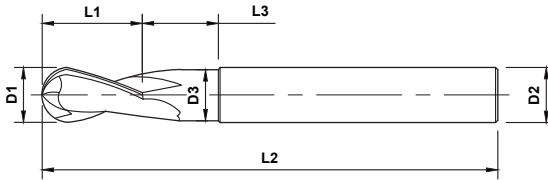

Uncoated

Length Key (K)

■ Stub
 ■ Standard
 ■ Long



	OD	LOC	SHK	OAL	Neck OD	NeckLength	Uncoated	PowerA
	D1	L1	D2	L2	D3	L3		
	1.0	1.2	3	50	0.95	3	542-002	542-002-1
	1.2	1.8	3	50	1.45	4.5	542-004	542-004-1
	2.0	2.4	3	50	1.95	6	542-006	542-006-1
	2.5	3	3	50	2.45	7.5	542-008	542-008-1
	3.0	3.6	3	50	2.95	9	542-010	542-010-1

BALL NECKED EXTENDED REACH MOLD MILLS

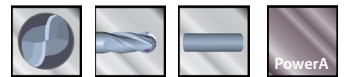

볼 넥 연장 길이 몰드 밀

Length Key (K)

■ Stub
 ■ Standard
 ■ Long



	OD	LOC	SHK	OAL	Neck OD	Neck Length	Uncoated	PowerA
	D1	L1	D2	L2	D3	L3		
	1	1.2	3	50	0.95	5	542-102	542-102-1
	1.2	1.4	3	50	1.15	6	542-104	542-104-1
	1.5	1.8	3	50	1.45	7.5	542-106	542-106-1
	1.8	2.2	3	50	1.75	9	542-108	542-108-1
	2	2.4	3	50	1.95	10	542-110	542-110-1
	2.3	2.8	3	50	2.25	11.5	542-112	542-112-1
	2.5	3	3	50	2.45	12.5	542-114	542-114-1
	2.8	3.4	3	50	2.75	14	542-116	542-116-1
	3	3.6	3	50	2.95	15	542-118	542-118-1

3FL 60° HELIX TWISTERMILL

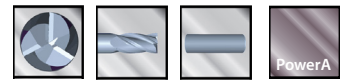

3FL 60° 헬릭스 트위터밀

HIGH PERFORMANCE ENDMILLS

3 Flutes	coated and uncoated	60° Helix for stainless steels and hi-temp alloys
3 플루트	코팅 및 비코팅	스테인레스강 및 고온 합금용 60° 헬릭스

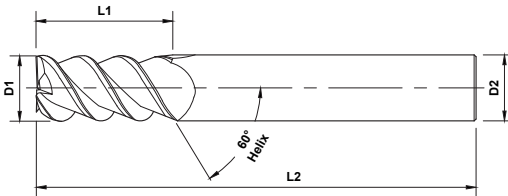

Uncoated

Length Key (K)

■ Stub
 ■ Standard
 ■ Long



	OD	LOC	SHK	OAL	Uncoated	PowerA
	D1	L1	D2	L2		
Standard	6	20	6	63	532-002	532-002-1
	8	22	8	63	532-004	532-004-1
	10	25	10	70	532-006	532-006-1
	12	25	12	75	532-008	532-008-1
	16	30	16	88	532-010	532-010-1
	20	38	20	100	532-012	532-012-1

ROUGHERS - COARSE PITCH

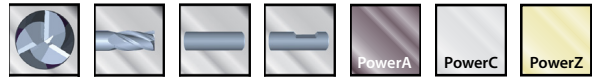

러퍼 - 거친 피치

3 Flutes	coated and uncoated	Rigid design for fast material removal
3 플루트	코팅 및 비코팅	신속한 재료 제거를 위한 엄격한 디자인

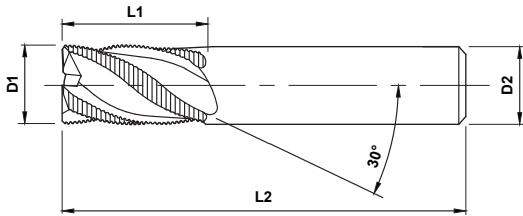

PowerA



PowerZ

Length Key (K)

■ Stub
 ■ Standard
 ■ Long



	OD	LOC	SHK	OAL	Flutes	Uncoated	PowerA	PowerC	PowerZ
	D1	L1	D2	L2					
Standard	6	19	6	63	3	533-002	533-002-1	533-002-3	533-002-4
	8	19	8	63	3	533-004	533-004-1	533-004-3	533-004-4
	10	22	10	63	3	533-006	533-006-1	533-006-3	533-006-4
	12	25	12	75	3	-	533-008-1	533-008-3	533-008-4
	16	32	16	88	3	-	533-010-1	533-010-3	533-010-4
	20	38	20	100	3	-	533-012-1	533-012-3	533-012-4
	25	38	25	100	3	-	533-014-1	533-014-3	533-014-4
Long	12	25	12	75	3	533-008W	533-008W-1	533-008W-3	533-008W-4
	16	32	16	88	3	533-010W	533-010W-1	533-010W-3	533-010W-4
	20	38	20	100	3	533-012W	533-012W-1	533-012W-3	533-012W-4
	25	38	25	100	3	533-014W	533-014W-1	533-014W-3	533-014W-4

'W' appended to part numbers indicates this tool is manufactured with a flat on the shank.
 부품 번호에 추가된 'W'는 이 공구가 샹크에서 플랫폼으로 제조되었음을 나타냅니다.

ROUGHERS - FINE PITCH

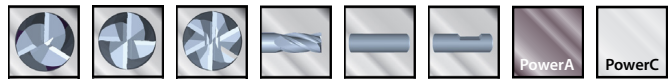

러퍼 - 미세 피치

HIGH PERFORMANCE ENDMILLS

3, 4 & 6 Flutes	coated and uncoated	Rigid design for fast material removal
3, 4 및 6 플루트	코팅 및 비코팅	신속한 재료 제거를 위한 엄격한 디자인

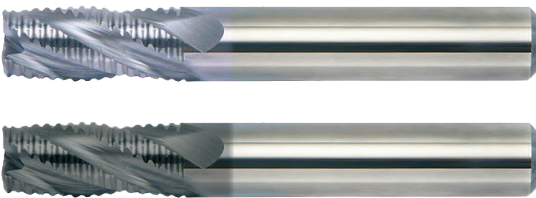
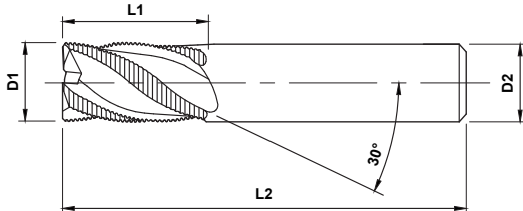

PowerC
PowerA

Length Key (K)

Stub Standard Long

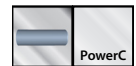

	OD	LOC	SHK	OAL	Flutes	Uncoated	PowerA	PowerC
	D1	L1	D2	L2				
Standard	6	19	6	63	3	533-102	533-102-1	533-102-3
	8	19	8	63	3	533-104	533-104-1	533-104-3
	10	22	10	63	3	533-106	533-106-1	533-106-3
	12	25	12	75	4	-	533-108-1	533-108-3
	16	32	16	88	4	-	533-110-1	533-110-3
	20	38	20	100	4	-	533-112-1	533-112-3
Long	25	38	25	100	6	-	533-114-1	533-114-3
	12	25	12	75	4	533-108W	533-108W-1	533-108W-3
	16	32	16	88	4	533-110W	533-110W-1	533-110W-3
	20	38	20	100	4	533-112W	533-112W-1	533-112W-3
Long	25	38	25	100	6	533-114W	533-114W-1	533-114W-3

'W' appended to part numbers indicates this tool is manufactured with a flat on the shank.
부품 번호에 추가된 'W'는 이 공구가 샹크에서 플랫폼으로 제조되었음을 나타냅니다.

ROUGHERS - MEDIUM PITCH

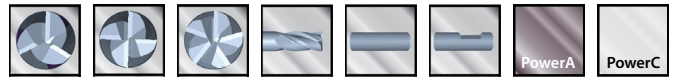

러퍼 - 중간 피치

3, 4 & 5 Flutes	coated and uncoated	Rigid design for fast material removal
3, 4 및 5 플루트	코팅 및 비코팅	신속한 재료 제거를 위한 엄격한 디자인

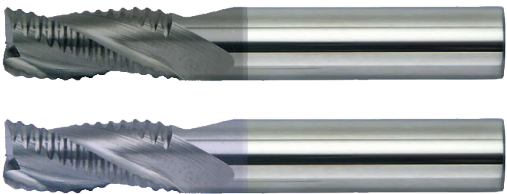
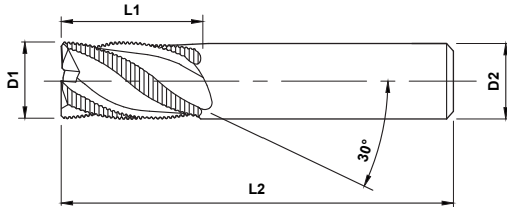

PowerA
PowerC

Length Key (K)

Stub Standard Long



	OD	LOC	SHK	OAL	Flutes	Uncoated	PowerA	PowerC
	D1	L1	D2	L2				
Stub	6	19	6	63	3	533-202	533-202-1	533-202-3
	8	19	8	63	3	533-204	533-204-1	533-204-3
	10	22	10	63	3	533-206	533-206-1	533-206-3
	12	25	12	75	4	-	533-208-1	533-208-3
	16	32	16	88	4	-	533-210-1	533-210-3
	20	38	20	100	4	-	533-212-1	533-212-3
	25	38	25	100	5	-	533-214-1	533-214-3



Standard	12	25	12	75	4	533-208W	533-208W-1	533-208W-3
	16	32	16	88	4	533-210W	533-210W-1	533-210W-3
	20	38	20	100	4	533-212W	533-212W-1	533-212W-3
	25	38	25	100	5	533-214W	533-214W-1	533-214W-3

'W' appended to part numbers indicates this tool is manufactured with a flat on the shank.
부품 번호에 추가된 'W'는 이 공구가 샹크에서 플랫폼으로 제조되었음을 나타냅니다.

SQUARE END AXMILLS

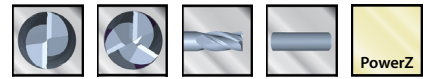

HIGH PERFORMANCE ENDMILLS

스퀘어 엔드 악스밀

2 & 3 Flutes	coated and uncoated	Unique flute and relief angles for aluminum	Faster speeds and feeds
2 및 3 플루트	코팅 및 비코팅	알루미늄에 대한 고유한 플루트 및 릴리프 각도	더 빠른 속도 및 피드

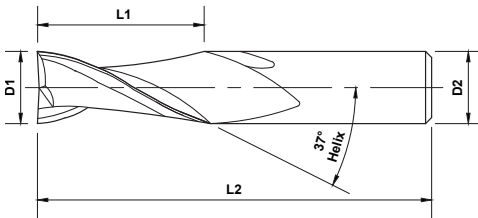

Non-Ferrous
N



Uncoated



PowerZ



Length Key (K)

Stub
 Standard
 Long

Quick Ship Items



	OD	LOC	SHK	OAL	Uncoated		PowerZ	
					2 Flute	3 Flute	2 Flute	3 Flute
	D1	L1	D2	L2				
	6	19	6	63	514-002	520-002	514-002-4	520-002-4
	8	20	8	63	514-004	520-004	514-004-4	520-004-4
	10	22	10	63	514-006	520-006	514-006-4	520-006-4
	12	25	12	75	514-008	520-008	514-008-4	520-008-4
	16	32	16	88	514-010	520-010	514-010-4	520-010-4
	20	36	20	100	514-012	520-012	514-012-4	520-012-4

CORNER RADIUS AXMILLS

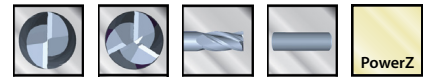

코너 반경 악스밀

2 & 3 Flutes	coated and uncoated	Unique flute and relief angles for aluminum	Faster speeds and feeds
2 및 3 플루트	코팅 및 비코팅	알루미늄에 대한 고유한 플루트 및 릴리프 각도	더 빠른 속도 및 피드

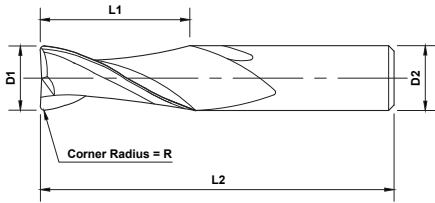

Non-Ferrous
N

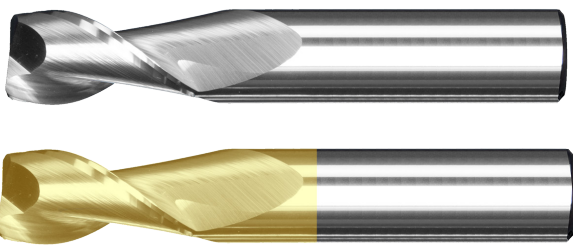

Uncoated
PowerZ



Length Key (K)

Stub
 Standard
 Long



	OD	LOC	SHK	OAL	Radius	Uncoated		PowerZ	
						2 Flute	3 Flute	2 Flute	3 Flute
	D1	L1	D2	L2	R				
6		19	6	63	0.50	514-401	520-401	514-401-4	520-401-4
		19	6	63	1.00	514-403	520-403	514-403-4	520-403-4
8		20	8	63	0.50	514-411	520-411	514-411-4	520-411-4
		20	8	63	1.00	514-413	520-413	514-413-4	520-413-4
10		22	10	63	0.50	514-421	520-421	514-421-4	520-421-4
		22	10	63	1.00	514-423	520-423	514-423-4	520-423-4
12		25	12	75	0.50	514-431	520-431	514-431-4	520-431-4
		25	12	75	1.00	514-433	520-433	514-433-4	520-433-4
16		32	16	88	0.50	514-441	520-441	514-441-4	520-441-4
		32	16	88	1.00	514-443	520-443	514-443-4	520-443-4
20		36	20	100	0.50	514-451	520-451	514-451-4	520-451-4
		36	20	100	1.00	514-453	520-453	514-453-4	520-453-4

SQUARE END CHIPBREAKER AXMILLS

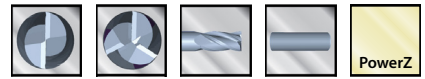

스퀘어 엔드 칩브레이커 악스밀

HIGH PERFORMANCE ENDMILLS

2 & 3 Flutes	coated and uncoated	Unique flute and relief angles for aluminum	Faster speeds and feeds
2 및 3 플루트	코팅 및 비코팅	알루미늄에 대한 고유한 플루트 및 릴리프 각도	더 빠른 속도 및 피드

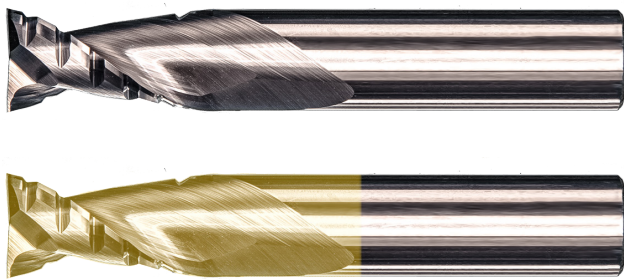
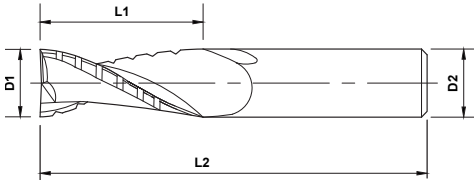

Uncoated
PowerZ



Length Key (K)

Stub
 Standard
 Long



	OD	LOC	SHK	OAL	Uncoated		PowerZ	
					2 Flute	3 Flute	2 Flute	3 Flute
	D1	L1	D2	L2	2 Flute	3 Flute	2 Flute	3 Flute
	6	19	6	63	517-002	523-002	517-002-4	523-002-4
	8	20	8	63	517-004	523-004	517-004-4	523-004-4
	10	22	10	63	517-006	523-006	517-006-4	523-006-4
	12	25	12	75	517-008	523-008	517-008-4	523-008-4
	16	32	16	88	517-010	523-010	517-010-4	523-010-4
	20	36	20	100	517-012	523-012	517-012-4	523-012-4

CORNER RADIUS CHIPBREAKER AXMILLS

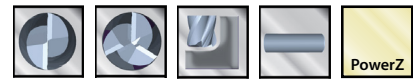

코너 반경 칩브레이커 악스밀

2 & 3 Flutes	coated and uncoated	Unique flute and relief angles for aluminum	Faster speeds and feeds
2 및 3 플루트	코팅 및 비코팅	알루미늄에 대한 고유한 플루트 및 릴리프 각도	더 빠른 속도 및 피드

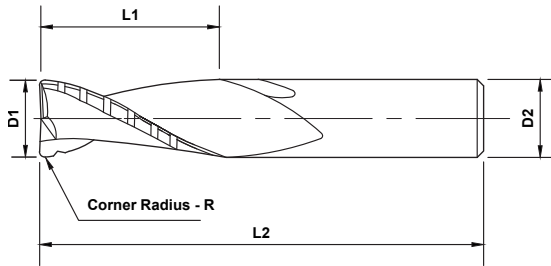

Non-Ferrous
N

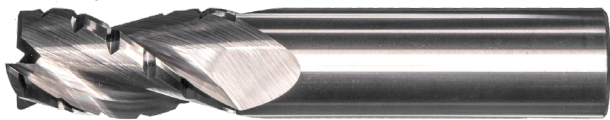

Uncoated



Length Key (K)

Stub
 Standard
 Long



	OD	LOC	SHK	OAL	Radius	Uncoated		PowerZ	
	D1	L1	D2	L2	R				
6		19	6	63	0.50	517-401	523-401	517-401-4	523-401-4
		19	6	63	1.00	517-403	523-403	517-403-4	523-403-4
8		20	8	63	0.50	517-411	523-411	517-411-4	523-411-4
		20	8	63	1.00	517-413	523-413	517-413-4	523-413-4
10		22	10	63	0.50	517-421	523-421	517-421-4	523-421-4
		22	10	63	1.00	517-423	523-423	517-423-4	523-423-4
12		25	12	75	0.50	517-431	523-431	517-431-4	523-431-4
		25	12	75	1.00	517-433	523-433	517-433-4	523-433-4
16		32	16	88	0.50	517-441	523-441	517-441-4	523-441-4
		32	16	88	1.00	517-443	523-443	517-443-4	523-443-4
20		36	20	100	0.50	517-451	523-451	517-451-4	523-451-4
		36	20	100	1.00	517-453	523-453	517-453-4	523-453-4

45° HELIX SQUARE HYPERMILLS

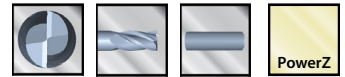

45° 헬릭스 스퀘어 하이퍼밀

HIGH PERFORMANCE ENDMILLS

2 Flutes	coated and uncoated
2 플루트	코팅 및 비코팅

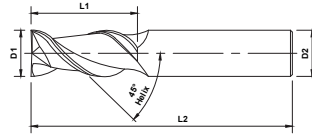

Non-Ferrous
N

	OD	LOC	SHK	OAL	Uncoated	PowerZ
	D1	L1	D2	L2		
	6	25	6	63	528-002	528-002-4
	8	25	8	63	528-004	528-004-4
	10	25	10	70	528-006	528-006-4
	12	32	12	75	528-008	528-008-4
	16	42	16	88	528-010	528-010-4
	20	48	20	100	528-012	528-012-4

55° HELIX SQUARE ALUMAZIPS

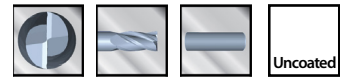

55° 헬릭스 스퀘어 알루마집

2 Flutes	uncoated
2 플루트	비코팅

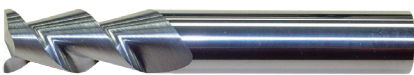

Uncoated

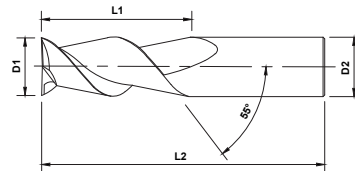

Non-Ferrous
N

	OD	LOC	SHK	OAL	Uncoated
	D1	L1	D2	L2	
	3	12	3	38	528-202
	4	14	4	50	528-204
	5	19	5	50	528-206
	6	19	6	63	528-208
	8	19	8	63	528-210
	10	22	10	70	528-212
	12	25	12	83	528-214
	14	30	14	83	528-216
	16	32	16	88	528-218
	20	38	20	100	528-220
	25	38	25	100	528-222

PRO+ PERFORMANCE ENDMILLS

초고성능 엔드밀

- V4 Pro+
- V5 Pro+
- HY5 Pro+
- F45 Pro+
- V7 Pro+

PRO+

Harness the power of our silicon based coatings;
PowerN and PowerNR.

These coatings make our tools outstanding in
high heat applications suited for hard material
machining.

Our special honed flutes result in quieter running
and an increase in overall tool precision.

실리콘 기반 코팅 성능 활용; PowerN 및 PowerNR.

이러한 코팅 덕분에 당사의 공구는 단단한 소재
가공에 적합한 고온 응용 분야에서 탁월한 성능을
발휘합니다.

당사의 특수 연마된 플루트는 조용한 주행과
전반적인 공구 정밀도 향상을 가져옵니다.

TABLE OF CONTENTS - 목차

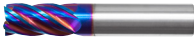









	V4 Pro+ Square Endmills <i>V4%</i> V4 울트라 스퀘어 엔드밀84	Cermet	Hardened H	Cast Iron K	Titanium S	Stainless M	Steel P
	V4 Pro+ Ball Endmills <i>V4%</i> V4 울트라 볼 엔드밀86	Cermet	Hardened H	Cast Iron K	Titanium S	Stainless M	Steel P
	V4 Pro+ Corner Radius Endmills <i>V4%</i> V4 울트라 코너 반경 엔드밀88	Cermet	Hardened H	Cast Iron K	Titanium S	Stainless M	Steel P
	V5 Pro+ Square Endmills <i>V5%</i> V5 울트라 스퀘어 엔드밀93	Cermet	Hardened H	Cast Iron K	Titanium S	Stainless M	Steel P
	V5 Pro+ Ball Endmills <i>V5%</i> V5 울트라 볼 엔드밀94	Cermet	Hardened H	Cast Iron K	Titanium S	Stainless M	Steel P
	V5 Pro+ Corner Radius Endmills <i>V5%</i> V5 울트라 코너 반경 엔드밀95	Cermet	Hardened H	Cast Iron K	Titanium S	Stainless M	Steel P
	HY5 Pro+ Square Endmills <i>HY5</i> HY5 울트라 스퀘어 엔드밀96	Cermet	Hardened H	Cast Iron K	Titanium S	Stainless M	Steel P
	HY5 Pro+ Corner Radius Endmills <i>HY5</i> HY5 울트라 코너 반경 엔드밀97	Cermet	Hardened H	Cast Iron K	Titanium S	Stainless M	Steel P
	F45 Pro+ Square Endmills <i>F45</i> F45 울트라 6FL 스퀘어 엔드밀102	Cermet	Hardened H	Cast Iron K	Titanium S	Stainless M	Steel P
	F45 Pro+ Corner Radius Endmills <i>F45</i> F45 울트라 6FL 코너 반경 엔드밀103	Cermet	Hardened H	Cast Iron K	Titanium S	Stainless M	Steel P
	V7 Pro+ Endmills <i>V7</i> V7 울트라103	Cermet	Hardened H	Cast Iron K	Titanium S	Stainless M	Steel P

PRO+ PERFORMANCE ENDMILLS

LEGENDS



범례

Features - 기능

	4 Flutes 4 플루트		Square End 스퀘어 엔드		Ball End 볼 엔드
	5 Flutes 5 플루트		Plain Shank 플레인 샹크		Double End Sq. 더블 엔드 스퀘어
	6+ Flutes 6+ 플루트		Corner Radius 코너 반경		Double End Ball 더블 엔드 볼
	Weldon Flat 웰던 플랫				

Coatings

코팅

	Uncoated 비코팅		PowerN PowerN (nACo)		PowerNR PowerNR (nACro)
---	-----------------	---	-------------------------	---	----------------------------

V4 PRO+ SQUARE ENDMILLS

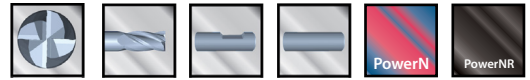

V4 울트라 스퀘어 엔드밀

4 Flutes	Coated with or without flat	Unique variable design, coating, and edge quality
4 플루트	플랫 포함 또는 플랫 없이 코팅	고유한 가변 디자인, 코팅 및 에지 품질

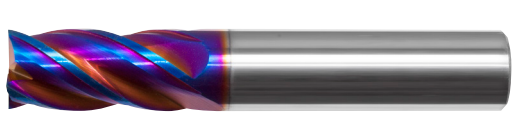
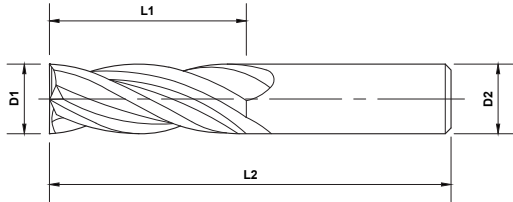

- Stub, Series 552, PowerN
- Standard, Series 550, PowerN
- Long, Series 551, PowerN



- Stub, Series 552, PowerNR
- Standard, Series 550, PowerNR
- Long, Series 551, PowerNR



Length Key (K)

- Standard
- Stub
- Long



K	OD D1	LOC L1	SHK D2	OAL L2	PowerN		PowerNR	
					No Flat	With Flat	No Flat	With Flat
3		6	3	38	552-002-5	552-002W-5	552-002-8	552-002W-8
		12	3	38	550-002-5	550-002W-5	550-002-8	550-002W-8
		20	3	65	551-002-5	551-002W-5	551-002-8	551-002W-8
4		8	4	50	552-004-5	552-004W-5	552-004-8	552-004W-8
		20	4	65	551-004-5	551-004W-5	551-004-8	551-004W-8
5		10	5	50	552-006-5	552-006W-5	552-006-8	552-006W-8
		16	5	50	550-014-5	550-014W-5	550-014-8	550-014W-8
		20	5	75	551-006-5	551-006W-5	551-006-8	551-006W-8
6		12	6	50	552-008-5	552-008W-5	552-008-8	552-008W-8
		19	6	63	550-018-5	550-018W-5	550-018-8	550-018W-8
		25	6	75	551-008-5	551-008W-5	551-008-8	551-008W-8
8		12	8	50	552-012-5	552-012W-5	552-012-8	552-012W-8
		19	8	63	550-020-5	550-020W-5	550-020-8	550-020W-8
		25	8	75	551-010-5	551-010W-5	551-010-8	551-010W-8
10		14	10	50	552-014-5	552-014W-5	552-014-8	552-014W-8
		22	10	70	550-022-5	550-022W-5	550-022-8	550-022W-8
		38	10	100	551-012-5	551-012W-5	551-012-8	551-012W-8

We manufacture a full range of cutting diameters. Please call for availability.
 당사는 모든 범위의 커팅 직경을 제조합니다. 전화로 구입할 수 있는지 문의하십시오.

V4 PRO+ SQUARE ENDMILLS

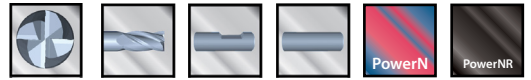

V4 울트라 스퀘어 엔드밀

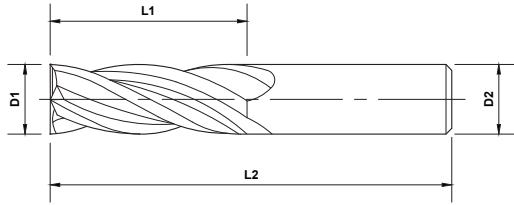

PRO+ PERFORMANCE ENDMILLS



Length Key (K)

Standard Stub Long



K	OD	LOC	SHK	OAL	PowerN		PowerNR	
	D1	L1	D2	L2	No Flat	With Flat	No Flat	With Flat
12	12	16	12	63	552-016-5	552-016W-5	552-016-8	552-016W-8
		25	12	75	550-024-5	550-024W-5	550-024-8	550-024W-8
		50	12	100	551-014-5	551-014W-5	551-014-8	551-014W-8
14	14	25	14	88	550-026-5	550-026W-5	550-026-8	550-026W-8
		56	14	125	551-016-5	551-016W-5	551-016-8	551-016W-8
16	16	32	16	88	550-028-5	550-028W-5	550-028-8	550-028W-8
		56	16	150	551-018-5	551-018W-5	551-018-8	551-018W-8
18	18	36	18	100	550-030-5	550-030W-5	550-030-8	550-030W-8
		56	18	150	551-020-5	551-020W-5	551-020-8	551-020W-8
20	20	38	20	100	550-032-5	550-032W-5	550-032-8	550-032W-8
		56	20	150	551-022-5	551-022W-5	551-022-8	551-022W-8
25	25	38	25	100	550-034-5	550-034W-5	550-034-8	550-034W-8
		70	25	150	551-024-5	551-024W-5	551-024-8	551-024W-8

We manufacture a full range of cutting diameters. Please call for availability.
당사는 모든 범위의 커팅 직경을 제조합니다. 전화로 구입할 수 있는지 문의하십시오.

V4 PRO+ BALL ENDMILLS

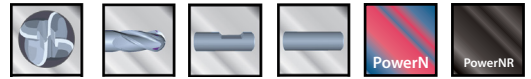

V4 울트라 볼 엔드밀

4 Flutes	Coated with or without flat	Unique variable design, coating, and edge quality
4 플루트	플랫 포함 또는 플랫 없이 코팅	고유한 가변 디자인, 코팅 및 에지 품질

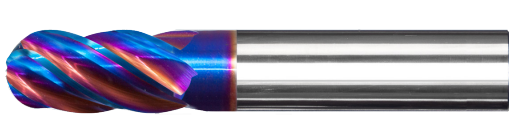
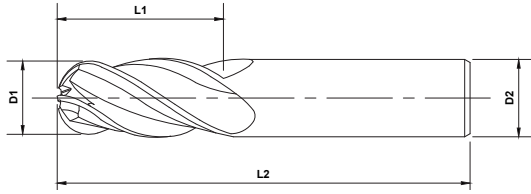

- Stub, Series 552, PowerN
- Standard, Series 550, PowerN
- Long, Series 551, PowerN



- Stub, Series 552, PowerNR
- Standard, Series 550, PowerNR
- Long, Series 551, PowerNR

Length Key (K)

Standard Stub Long



K	OD	LOC	SHK	OAL	PowerN		PowerNR	
	D1	L1	D2	L2	No Flat	With Flat	No Flat	With Flat
3		6	3	38	552-202-5	552-202W-5	552-202-8	552-202W-8
		12	3	38	550-202-5	550-202W-5	550-202-8	550-202W-8
		20	3	65	551-202-5	551-202W-5	551-202-8	551-202W-8
4		8	4	50	552-204-5	552-204W-5	552-204-8	552-204W-8
		14	4	50	550-208-5	550-208W-5	550-208-8	550-208W-8
		20	4	65	551-204-5	551-204W-5	551-204-8	551-204W-8
5		10	5	50	552-206-5	552-206W-5	552-206-8	552-206W-8
		16	5	50	550-214-5	550-214W-5	550-214-8	550-214W-8
		25	5	75	551-206-5	551-206W-5	551-206-8	551-206W-8
6		12	6	50	552-208-5	552-208W-5	552-208-8	552-208W-8
		19	6	63	550-218-5	550-218W-5	550-218-8	550-218W-8
		25	6	75	551-208-5	551-208W-5	551-208-8	551-208W-8
8		12	8	50	552-212-5	552-212W-5	552-212-8	552-212W-8
		19	8	63	550-220-5	550-220W-5	550-220-8	550-220W-8
		25	8	75	551-210-5	551-210W-5	551-210-8	551-210W-8
10		14	10	50	552-214-5	552-214W-5	552-214-8	552-214W-8
		22	10	70	550-222-5	550-222W-5	550-222-8	550-222W-8
		38	10	100	551-212-5	551-212W-5	551-212-8	551-212W-8

We manufacture a full range of cutting diameters. Please call for availability.
당사는 모든 범위의 커팅 직경을 제조합니다. 전화로 구입할 수 있는지 문의하십시오.

V4 PRO+ BALL ENDMILLS

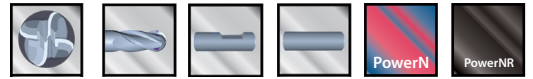

V4 울트라 볼 엔드밀

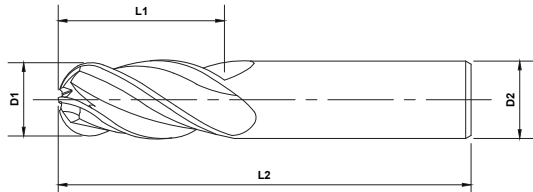

PRO+ PERFORMANCE ENDMILLS

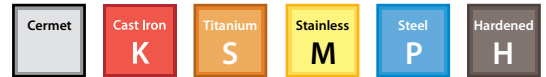

Length Key (K)

Standard Stub Long



K	OD	LOC	SHK	OAL	PowerN		PowerNR	
	D1	L1	D2	L2	No Flat	With Flat	No Flat	With Flat
12	12	16	12	63	552-216-5	552-216W-5	552-216-8	552-216W-8
		25	12	75	550-224-5	550-224W-5	550-224-8	550-224W-8
		50	12	100	551-214-5	551-214W-5	551-214-8	551-214W-8
14	14	25	14	88	550-226-5	550-226W-5	550-226-8	550-226W-8
		56	14	125	551-216-5	551-216W-5	551-216-8	551-216W-8
16	16	32	16	88	550-228-5	550-228W-5	550-228-8	550-228W-8
		56	16	150	551-218-5	551-218W-5	551-218-8	551-218W-8
18	18	36	18	100	550-230-5	550-230W-5	550-230-8	550-230W-8
		56	18	150	551-220-5	551-220W-5	551-220-8	551-220W-8
20	20	38	20	100	550-232-5	550-232W-5	550-232-8	550-232W-8
		56	20	150	551-222-5	551-222W-5	551-222-8	551-222W-8
25	25	38	25	100	550-234-5	550-234W-5	550-234-8	550-234W-8
		70	25	150	551-224-5	551-224W-5	551-224-8	551-224W-8

We manufacture a full range of cutting diameters. Please call for availability.
당사는 모든 범위의 커팅 직경을 제조합니다. 전화로 구입할 수 있는지 문의하십시오.

V4 PRO+ CORNER RADIUS

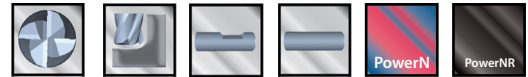

V4 울트라 코너 반경

4 Flutes	Coated with or without flat
4 플루트	플랫 포함 또는 플랫 없이 코팅
Unique variable design, coating, and edge quality	Quiet operation and better finish
고유한 가변 디자인, 코팅 및 에지 품질	조용한 작동과 더 나은 마무리

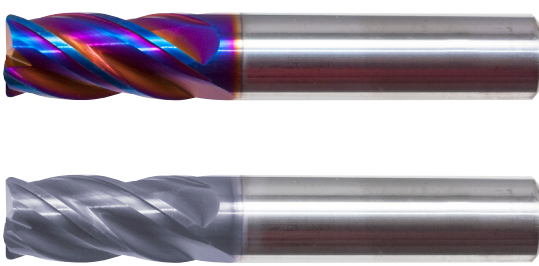
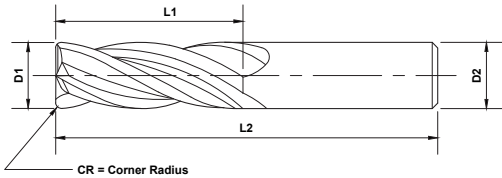

- Stub, Series 552, PowerN
- Standard, Series 550, PowerN
- Long, Series 551, PowerN
- Stub, Series 552, PowerNR
- Standard, Series 550, PowerNR
- Long, Series 551, PowerNR



Length Key (K)



K	OD	LOC	SHK	OAL	Radius	PowerN		PowerNR									
						No Flat	With Flat	No Flat	With Flat								
3	D1	L1	D2	L2	R	552-401-5	552-401W-5	552-401-8	552-401W-8								
										6	3	38	0.25	552-402-5	552-402W-5	552-402-8	552-402W-8
										6	3	38	0.50	552-403-5	552-403W-5	552-403-8	552-403W-8
										6	3	38	0.75	552-404-5	552-404W-5	552-404-8	552-404W-8
										12	3	38	1.00	550-400-5	550-400W-5	550-400-8	550-400W-8
										12	3	38	0.25	550-401-5	550-401W-5	550-401-8	550-401W-8
										12	3	38	0.50	550-402-5	550-402W-5	550-402-8	550-402W-8
										20	3	65	0.25	551-400-5	551-400W-5	551-400-8	551-400W-8
										20	3	65	0.50	551-401-5	551-401W-5	551-401-8	551-401W-8
										20	3	65	0.75	551-402-5	551-402W-5	551-402-8	551-402W-8
										20	3	65	1.00	551-403-5	551-403W-5	551-403-8	551-403W-8
										4	D1	L1	D2	L2	R	552-410-5	552-410W-5
8	4	50	0.25	552-411-5	552-411W-5	552-411-8	552-411W-8										
8	4	50	0.50	552-412-5	552-412W-5	552-412-8	552-412W-8										
8	4	50	0.75	552-413-5	552-413W-5	552-413-8	552-413W-8										
14	4	50	1.00	550-420-5	550-420W-5	550-420-8	550-420W-8										
14	4	50	0.25	550-421-5	550-421W-5	550-421-8	550-421W-8										
14	4	50	0.50	550-422-5	550-422W-5	550-422-8	550-422W-8										
14	4	50	0.75	550-423-5	550-423W-5	550-423-8	550-423W-8										
20	4	65	1.00	551-410-5	551-410W-5	551-410-8	551-410W-8										
20	4	65	0.25	551-411-5	551-411W-5	551-411-8	551-411W-8										
20	4	65	0.50	551-412-5	551-412W-5	551-412-8	551-412W-8										
20	4	65	0.75	551-413-5	551-413W-5	551-413-8	551-413W-8										
5	D1	L1	D2	L2	R	552-420-5	552-420W-5	552-420-8	552-420W-8								
										10	5	50	0.25	552-421-5	552-421W-5	552-421-8	552-421W-8
										10	5	50	0.50	552-422-5	552-422W-5	552-422-8	552-422W-8
										10	5	50	0.75	552-423-5	552-423W-5	552-423-8	552-423W-8
										10	5	50	1.00	550-440-5	550-440W-5	550-440-8	550-440W-8
										16	5	50	0.25	550-441-5	550-441W-5	550-441-8	550-441W-8

We manufacture a full range of cutting diameters. Please call for availability.
당사는 모든 범위의 커팅 직경을 제조합니다. 전화로 구입할 수 있는지 문의하십시오.

V4 PRO+ CORNER RADIUS

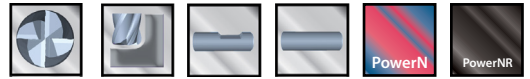

V4 울트라 코너 반경

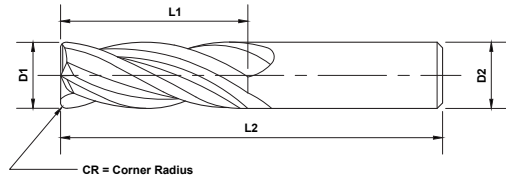

Length Key (K)

Standard Stub Long



K	OD	LOC	SHK	OAL	Radius	PowerN		PowerNR	
	D1	L1	D2	L2	R	No Flat	With Flat	No Flat	With Flat
5	16	16	5	50	0.75	550-442-5	550-442W-5	550-442-8	550-442W-8
		16	5	50	1.00	550-443-5	550-443W-5	550-443-8	550-443W-8
		20	5	75	0.25	551-420-5	551-420W-5	551-420-8	551-420W-8
		20	5	75	0.50	551-422-5	551-422W-5	551-422-8	551-422W-8
		20	5	75	0.75	551-423-5	551-423W-5	551-423-8	551-423W-8
		20	5	75	1.00	551-424-5	551-424W-5	551-424-8	551-424W-8
6	12	12	6	50	0.25	552-430-5	552-430W-5	552-430-8	552-430W-8
		12	6	50	0.50	552-431-5	552-431W-5	552-431-8	552-431W-8
		12	6	50	0.75	552-432-5	552-432W-5	552-432-8	552-432W-8
		12	6	50	1.00	552-433-5	552-433W-5	552-433-8	552-433W-8
		12	6	50	1.25	552-434-5	552-434W-5	552-434-8	552-434W-8
		12	6	50	1.50	552-435-5	552-435W-5	552-435-8	552-435W-8
	19	19	6	63	0.25	550-460-5	550-460W-5	550-460-8	550-460W-8
		19	6	63	0.50	550-461-5	550-461W-5	550-461-8	550-461W-8
		19	6	63	0.75	550-462-5	550-462W-5	550-462-8	550-462W-8
		19	6	63	1.00	550-463-5	550-463W-5	550-463-8	550-463W-8
		19	6	63	1.25	550-464-5	550-464W-5	550-464-8	550-464W-8
		19	6	63	1.50	550-465-5	550-465W-5	550-465-8	550-465W-8
	25	25	6	75	0.25	551-430-5	551-430W-5	551-430-8	551-430W-8
		25	6	75	0.50	551-431-5	551-431W-5	551-431-8	551-431W-8
		25	6	75	0.75	551-432-5	551-432W-5	551-432-8	551-432W-8
		25	6	75	1.00	551-433-5	551-433W-5	551-433-8	551-433W-8
		25	6	75	1.25	551-434-5	551-434W-5	551-434-8	551-434W-8
		25	6	75	1.50	551-435-5	551-435W-5	551-435-8	551-435W-8
8	12	12	8	50	0.50	552-451-5	552-451W-5	552-451-8	552-451W-8
		12	8	50	0.75	552-452-5	552-452W-5	552-452-8	552-452W-8
		12	8	50	1.00	552-453-5	552-453W-5	552-453-8	552-453W-8
		12	8	50	1.25	552-454-5	552-454W-5	552-454-8	552-454W-8
		12	8	50	1.50	552-455-5	552-455W-5	552-455-8	552-455W-8
		12	8	50	2.00	552-456-5	552-456W-5	552-456-8	552-456W-8
	19	19	8	63	0.50	550-471-5	550-471W-5	550-471-8	550-471W-8
		19	8	63	0.75	550-472-5	550-472W-5	550-472-8	550-472W-8
		19	8	63	1.00	550-473-5	550-473W-5	550-473-8	550-473W-8
		19	8	63	1.25	550-474-5	550-474W-5	550-474-8	550-474W-8
		19	8	63	1.50	550-475-5	550-475W-5	550-475-8	550-475W-8
		19	8	63	2.00	550-476-5	550-476W-5	550-476-8	550-476W-8
		19	8	63	3.00	550-477-5	550-477W-5	550-477-8	550-477W-8

We manufacture a full range of cutting diameters. Please call for availability. 당사는 모든 범위의 커팅 직경을 제조합니다. 전화로 구입할 수 있는지 문의하십시오.

V4 PRO+ CORNER RADIUS

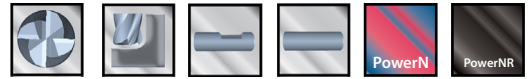

V4 울트라 코너 반경

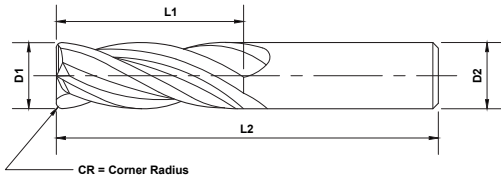

Length Key (K)



K	OD	LOC	SHK	OAL	Radius	PowerN		PowerNR	
	D1	L1	D2	L2	R	No Flat	With Flat	No Flat	With Flat
8	25	8	8	75	0.50	551-441-5	551-441W-5	551-441-8	551-441W-8
					0.75	551-442-5	551-442W-5	551-442-8	551-442W-8
					1.00	551-443-5	551-443W-5	551-443-8	551-443W-8
					1.25	551-444-5	551-444W-5	551-444-8	551-444W-8
					1.50	551-445-5	551-445W-5	551-445-8	551-445W-8
					2.00	551-446-5	551-446W-5	551-446-8	551-446W-8
					3.00	551-447-5	551-447W-5	551-447-8	551-447W-8
10	14	10	50	50	0.50	552-461-5	552-461W-5	552-461-8	552-461W-8
					0.75	552-462-5	552-462W-5	552-462-8	552-462W-8
					1.00	552-463-5	552-463W-5	552-463-8	552-463W-8
					1.25	552-464-5	552-464W-5	552-464-8	552-464W-8
					1.50	552-465-5	552-465W-5	552-465-8	552-465W-8
					2.00	552-466-5	552-466W-5	552-466-8	552-466W-8
	22	10	70	70	0.50	550-481-5	550-481W-5	550-481-8	550-481W-8
					0.75	550-482-5	550-482W-5	550-482-8	550-482W-8
					1.00	550-483-5	550-483W-5	550-483-8	550-483W-8
					1.25	550-484-5	550-484W-5	550-484-8	550-484W-8
					1.50	550-485-5	550-485W-5	550-485-8	550-485W-8
					2.00	550-486-5	550-486W-5	550-486-8	550-486W-8
					3.00	550-487-5	550-487W-5	550-487-8	550-487W-8
					38	10	100	100	0.50
0.75	551-452-5	551-452W-5	551-452-8	551-452W-8					
1.00	551-453-5	551-453W-5	551-453-8	551-453W-8					
1.25	551-454-5	551-454W-5	551-454-8	551-454W-8					
1.50	551-455-5	551-455W-5	551-455-8	551-455W-8					
2.00	551-456-5	551-456W-5	551-456-8	551-456W-8					
12	16	12	63	63	0.50	552-471-5	552-471W-5	552-471-8	552-471W-8
					0.75	552-472-5	552-472W-5	552-472-8	552-472W-8
					1.00	552-473-5	552-473W-5	552-473-8	552-473W-8
					1.25	552-474-5	552-474W-5	552-474-8	552-474W-8
					1.50	552-475-5	552-475W-5	552-475-8	552-475W-8
					2.00	552-476-5	552-476W-5	552-476-8	552-476W-8
					3.00	552-477-5	552-477W-5	552-477-8	552-477W-8
					4.00	552-478-5	552-478W-5	552-478-8	552-478W-8
	25	12	75	75	0.50	550-491-5	550-491W-5	550-491-8	550-491W-8
					0.75	550-492-5	550-492W-5	550-492-8	550-492W-8
					1.00	550-493-5	550-493W-5	550-493-8	550-493W-8
					1.25	550-494-5	550-494W-5	550-494-8	550-494W-8
					1.50	550-495-5	550-495W-5	550-495-8	550-495W-8
					2.00	550-496-5	550-496W-5	550-496-8	550-496W-8
25	12	75	75	3.00	550-497-5	550-497W-5	550-497-8	550-497W-8	
				4.00	550-498-5	550-498W-5	550-498-8	550-498W-8	

We manufacture a full range of cutting diameters. Please call for availability.
당사는 모든 범위의 커팅 직경을 제조합니다. 전화로 구입할 수 있는지 문의하십시오.

V4 PRO+ CORNER RADIUS

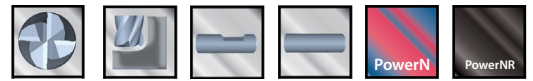

V4 울트라 코너 반경

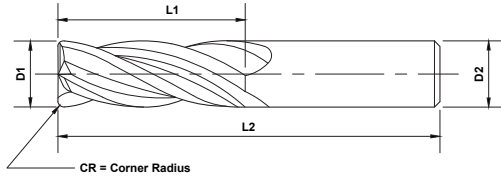

Length Key (K)



PRO+ PERFORMANCE ENDMILLS

K	OD	LOC	SHK	OAL	Radius	PowerN		PowerNR	
	D1	L1	D2	L2	R	No Flat	With Flat	No Flat	With Flat
12	50	50	12	100	0.50	551-461-5	551-461W-5	551-461-8	551-461W-8
		50	12	100	0.75	551-462-5	551-462W-5	551-462-8	551-462W-8
		50	12	100	1.00	551-463-5	551-463W-5	551-463-8	551-463W-8
		50	12	100	1.25	551-464-5	551-464W-5	551-464-8	551-464W-8
		50	12	100	1.50	551-465-5	551-465W-5	551-465-8	551-465W-8
		50	12	100	2.00	551-466-5	551-466W-5	551-466-8	551-466W-8
		50	12	100	3.00	551-467-5	551-467W-5	551-467-8	551-467W-8
		50	12	100	4.00	551-468-5	551-468W-5	551-468-8	551-468W-8
14	56	25	14	88	0.50	550-501-5	550-501W-5	550-501-8	550-501W-8
		25	14	88	0.75	550-502-5	550-502W-5	550-502-8	550-502W-8
		25	14	88	1.00	550-503-5	550-503W-5	550-503-8	550-503W-8
		25	14	88	1.50	550-505-5	550-505W-5	550-505-8	550-505W-8
		25	14	88	2.00	550-506-5	550-506W-5	550-506-8	550-506W-8
		25	14	88	3.00	550-507-5	550-507W-5	550-507-8	550-507W-8
		25	14	88	4.00	550-508-5	550-508W-5	550-508-8	550-508W-8
		25	14	125	0.50	551-471-5	551-471W-5	551-471-8	551-471W-8
		25	14	125	0.75	551-472-5	551-472W-5	551-472-8	551-472W-8
		25	14	125	1.00	551-473-5	551-473W-5	551-473-8	551-473W-8
		25	14	125	1.50	551-475-5	551-475W-5	551-475-8	551-475W-8
		25	14	125	2.00	551-476-5	551-476W-5	551-476-8	551-476W-8
		25	14	125	3.00	551-477-5	551-477W-5	551-477-8	551-477W-8
		25	14	125	4.00	551-478-5	551-478W-5	551-478-8	551-478W-8
16	56	32	16	88	0.50	550-511-5	550-511W-5	550-511-8	550-511W-8
		32	16	88	0.75	550-512-5	550-512W-5	550-512-8	550-512W-8
		32	16	88	1.00	550-513-5	550-513W-5	550-513-8	550-513W-8
		32	16	88	1.50	550-515-5	550-515W-5	550-515-8	550-515W-8
		32	16	88	2.00	550-516-5	550-516W-5	550-516-8	550-516W-8
		32	16	88	3.00	550-517-5	550-517W-5	550-517-8	550-517W-8
		32	16	88	4.00	550-518-5	550-518W-5	550-518-8	550-518W-8
		32	16	150	0.50	551-481-5	551-481W-5	551-481-8	551-481W-8
		32	16	150	0.75	551-482-5	551-482W-5	551-482-8	551-482W-8
		32	16	150	1.00	551-483-5	551-483W-5	551-483-8	551-483W-8
		32	16	150	1.50	551-485-5	551-485W-5	551-485-8	551-485W-8
		32	16	150	2.00	551-486-5	551-486W-5	551-486-8	551-486W-8
		32	16	150	3.00	551-487-5	551-487W-5	551-487-8	551-487W-8
		32	16	150	4.00	551-488-5	551-488W-5	551-488-8	551-488W-8
18	36	36	18	100	0.50	550-521-5	550-521W-5	550-521-8	550-521W-8
		36	18	100	0.75	550-522-5	550-522W-5	550-522-8	550-522W-8
		36	18	100	1.00	550-523-5	550-523W-5	550-523-8	550-523W-8
		36	18	100	1.50	550-525-5	550-525W-5	550-525-8	550-525W-8
		36	18	100	2.00	550-526-5	550-526W-5	550-526-8	550-526W-8
		36	18	100	3.00	550-527-5	550-527W-5	550-527-8	550-527W-8
		36	18	100	4.00	550-528-5	550-528W-5	550-528-8	550-528W-8

We manufacture a full range of cutting diameters. Please call for availability.
당사는 모든 범위의 커팅 직경을 제조합니다. 전화로 구입할 수 있는지 문의하십시오.

V4 PRO+ CORNER RADIUS

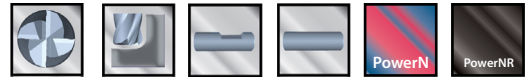

V4 울트라 코너 반경

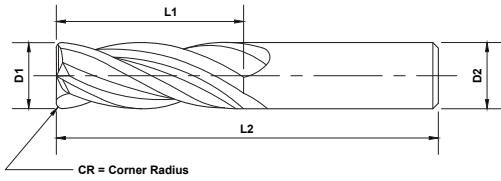

Length Key (K)

Standard Stub Long



K	OD	LOC	SHK	OAL	Radius	PowerN		PowerNR		
	D1	L1	D2	L2	R	No Flat	With Flat	No Flat	With Flat	
18	56	18	18	150	0.50	551-491-5	551-491W-5	551-491-8	551-491W-8	
					0.75	551-492-5	551-492W-5	551-492-8	551-492W-8	
					1.00	551-493-5	551-493W-5	551-493-8	551-493W-8	
					1.50	551-495-5	551-495W-5	551-495-8	551-495W-8	
					2.00	551-496-5	551-496W-5	551-496-8	551-496W-8	
					3.00	551-497-5	551-497W-5	551-497-8	551-497W-8	
					4.00	551-498-5	551-498W-5	551-498-8	551-498W-8	
20	38	20	100	100	0.50	550-531-5	550-531W-5	550-531-8	550-531W-8	
					0.75	550-532-5	550-532W-5	550-532-8	550-532W-8	
					1.00	550-533-5	550-533W-5	550-533-8	550-533W-8	
					1.50	550-535-5	550-535W-5	550-535-8	550-535W-8	
					2.00	550-536-5	550-536W-5	550-536-8	550-536W-8	
					3.00	550-537-5	550-537W-5	550-537-8	550-537W-8	
					4.00	550-538-5	550-538W-5	550-538-8	550-538W-8	
	56	20	150	150	150	0.50	551-501-5	551-501W-5	551-501-8	551-501W-8
						0.75	551-502-5	551-502W-5	551-502-8	551-502W-8
						1.00	551-503-5	551-503W-5	551-503-8	551-503W-8
						1.50	551-505-5	551-505W-5	551-505-8	551-505W-8
						2.00	551-506-5	551-506W-5	551-506-8	551-506W-8
						3.00	551-507-5	551-507W-5	551-507-8	551-507W-8
						4.00	551-508-5	551-508W-5	551-508-8	551-508W-8
5.00	551-509-5	551-509W-5	551-509-8	551-509W-8						
25	38	25	100	100	0.50	550-541-5	550-541W-5	550-541-8	550-541W-8	
					0.75	550-542-5	550-542W-5	550-542-8	550-542W-8	
					1.00	550-543-5	550-543W-5	550-543-8	550-543W-8	
					1.50	550-545-5	550-545W-5	550-545-8	550-545W-8	
					2.00	550-546-5	550-546W-5	550-546-8	550-546W-8	
					3.00	550-547-5	550-547W-5	550-547-8	550-547W-8	
					4.00	550-548-5	550-548W-5	550-548-8	550-548W-8	
	70	25	150	150	150	0.50	551-511-5	551-511W-5	551-511-8	551-511W-8
						0.75	551-512-5	551-512W-5	551-512-8	551-512W-8
						1.00	551-513-5	551-513W-5	551-513-8	551-513W-8
						1.50	551-515-5	551-515W-5	551-515-8	551-515W-8
						2.00	551-516-5	551-516W-5	551-516-8	551-516W-8
						3.00	551-517-5	551-517W-5	551-517-8	551-517W-8
						4.00	551-518-5	551-518W-5	551-518-8	551-518W-8
5.00	551-519-5	551-519W-5	551-519-8	551-519W-8						

We manufacture a full range of cutting diameters. Please call for availability.
당사는 모든 범위의 커팅 직경을 제조합니다. 전화로 구입할 수 있는지 문의하십시오.

V5 PRO+ SQUARE ENDMILLS

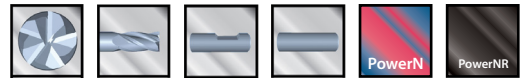

V5 울트라 스퀘어 엔드밀

5 Flutes 5 플루트	Coated with or without flat 플랫 포함 또는 플랫 없이 코팅	Quiet operation and better finish 조용한 작동과 더 나은 마무리
-------------------	--	---

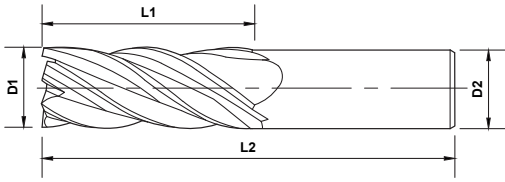

PRO+ PERFORMANCE ENDMILLS

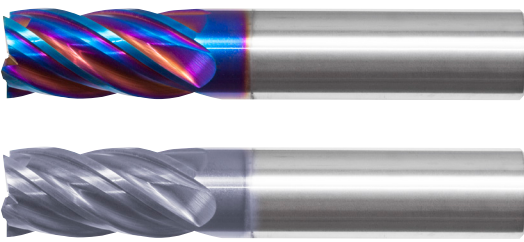

- Stub, Series 555, PowerN
 - Standard, Series 553, PowerN
 - Long, Series 554, PowerN
-
- Stub, Series 555, PowerNR
 - Standard, Series 553, PowerNR
 - Long, Series 554, PowerNR



Length Key (K)

Standard
 Stub
 Long



K	OD	LOC	SHK	OAL	PowerN		PowerNR	
	D1	L1	D2	L2	No Flat	With Flat	No Flat	With Flat
8		12	8	50	555-010-5	555-010W-5	555-010-8	555-010W-8
		19	8	63	553-010-5	553-010W-5	553-010-8	553-010W-8
		25	8	75	554-010-5	554-010W-5	554-010-8	554-010W-8
10		14	10	50	555-012-5	555-012W-5	555-012-8	555-012W-8
		22	10	70	553-012-5	553-012W-5	553-012-8	553-012W-8
		38	10	100	554-012-5	554-012W-5	554-012-8	554-012W-8
12		16	12	63	555-014-5	555-014W-5	555-014-8	555-014W-8
		25	12	75	553-014-5	553-014W-5	553-014-8	553-014W-8
		50	12	100	554-014-5	554-014W-5	554-014-8	554-014W-8
14		25	14	88	553-016-5	553-016W-5	553-016-8	553-016W-8
		56	14	125	554-016-5	554-016W-5	554-016-8	554-016W-8
16		32	16	88	553-018-5	553-018W-5	553-018-8	553-018W-8
		56	16	150	554-018-5	554-018W-5	554-018-8	554-018W-8
18		36	18	100	553-020-5	553-020W-5	553-020-8	553-020W-8
		56	18	150	554-020-5	554-020W-5	554-020-8	554-020W-8
20		38	20	100	553-022-5	553-022W-5	553-022-8	553-022W-8
		56	20	150	554-022-5	554-022W-5	554-022-8	554-022W-8
25		38	25	100	553-024-5	553-024W-5	553-024-8	553-024W-8
		70	25	150	554-024-5	554-024W-5	554-024-8	554-024W-8

We manufacture a full range of cutting diameters. Please call for availability.
당사는 모든 범위의 커팅 직경을 제조합니다. 전화로 구입할 수 있는지 문의하십시오.

V5 PRO+ BALL ENDMILLS

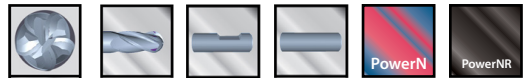

V5 울트라 볼 엔드밀

5 Flutes	Coated with or without flat	Quiet operation and better finish
5 플루트	플랫 포함 또는 플랫 없이 코팅	조용한 작동과 더 나은 마무리

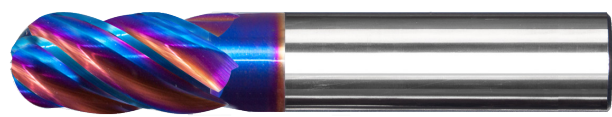
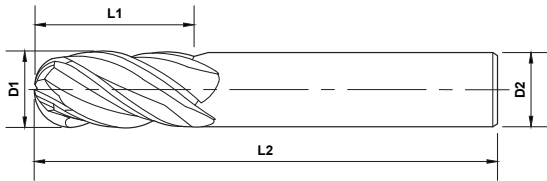

Stub, Series 555, PowerN
Standard, Series 553, PowerN
Long, Series 554, PowerN



Stub, Series 555, PowerNR
Standard, Series 553, PowerNR
Long, Series 554, PowerNR



Length Key (K)

Standard
Stub
Long



K	OD	LOC	SHK	OAL	PowerN		PowerNR	
	D1	L1	D2	L2	No Flat	With Flat	No Flat	With Flat
8	8	12	8	50	555-210-5	555-210W-5	555-210-8	555-210W-8
		19	8	63	553-210-5	553-210W-5	553-210-8	553-210W-8
		25	8	75	554-210-5	554-210W-5	554-210-8	554-210W-8
10	10	14	10	50	555-212-5	555-212W-5	555-212-8	555-212W-8
		22	10	70	553-212-5	553-212W-5	553-212-8	553-212W-8
		38	10	100	554-212-5	554-212W-5	554-212-8	554-212W-8
12	12	16	12	63	555-214-5	555-214W-5	555-214-8	555-214W-8
		25	12	75	553-214-5	553-214W-5	553-214-8	553-214W-8
		50	12	100	554-214-5	554-214W-5	554-214-8	554-214W-8
14	14	25	14	88	553-216-5	553-216W-5	553-216-8	553-216W-8
		56	14	125	554-216-5	554-216W-5	554-216-8	554-216W-8
16	16	32	16	88	553-218-5	553-218W-5	553-218-8	553-218W-8
		56	16	150	554-218-5	554-218W-5	554-218-8	554-218W-8
18	18	36	18	100	553-220-5	553-220W-5	553-220-8	553-220W-8
		56	18	150	554-220-5	554-220W-5	554-220-8	554-220W-8
20	20	38	20	100	553-222-5	553-222W-5	553-222-8	553-222W-8
		56	20	150	554-222-5	554-222W-5	554-222-8	554-222W-8
25	25	38	25	100	553-224-5	553-224W-5	553-224-8	553-224W-8
		70	25	150	554-224-5	554-224W-5	554-224-8	554-224W-8

We manufacture a full range of cutting diameters. Please call for availability.
 당사는 모든 범위의 커팅 직경을 제조합니다. 전화로 구입할 수 있는지 문의하십시오.

V5 PRO+ CORNER RADIUS

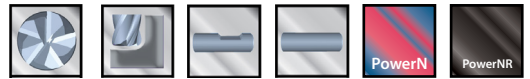

V5 울트라 코너 반경 엔드밀

5 Flutes 5 플루트	Coated with or without flat 플랫 포함 또는 플랫 없이 코팅	Quiet operation and better finish 조용한 작동과 더 나은 마무리
-------------------	--	---

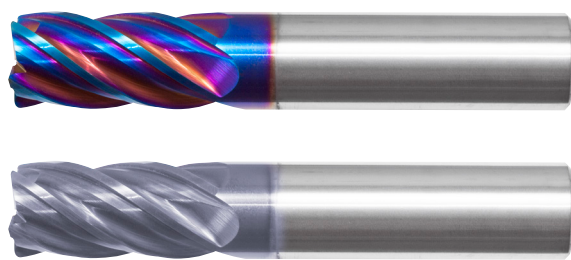
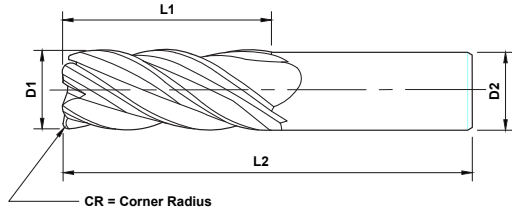

- Stub, Series 555, PowerN
 - Standard, Series 553, PowerN
 - Long, Series 554, PowerN
-
- Stub, Series 555, PowerNR
 - Standard, Series 553, PowerNR
 - Long, Series 554, PowerNR



Length Key (K)

- Standard
- Stub
- Long



K	OD D1	LOC L1	SHK D2	OAL L2	Radius R	PowerN		PowerNR	
						No Flat	With Flat	No Flat	With Flat
8	8	12	8	50	0.50	555-441-5	555-441W-5	555-441-8	555-441W-8
		19	8	63	0.50	553-441-5	553-441W-5	553-441-8	553-441W-8
		25	8	75	0.50	554-441-5	554-441W-5	554-441-8	554-441W-8
10	10	14	10	50	0.50	555-451-5	555-451W-5	555-451-8	555-451W-8
		22	10	70	0.50	553-451-5	553-451W-5	553-451-8	553-451W-8
		38	10	100	0.50	554-451-5	554-451W-5	554-451-8	554-451W-8
12	12	16	12	63	0.75	555-462-5	555-462W-5	555-462-8	555-462W-8
		25	12	75	0.75	553-462-5	553-462W-5	553-462-8	553-462W-8
		50	12	100	0.75	554-462-5	554-462W-5	554-462-8	554-462W-8
14	14	25	14	88	0.75	553-472-5	553-472W-5	553-472-8	553-472W-8
		56	14	125	0.75	554-472-5	554-472W-5	554-472-8	554-472W-8
16	16	32	16	88	0.75	553-482-5	553-482W-5	553-482-8	553-482W-8
		56	16	150	0.75	554-482-5	554-482W-5	554-482-8	554-482W-8
18	18	36	18	100	0.75	553-492-5	553-492W-5	553-492-8	553-492W-8
		56	18	150	0.75	554-492-5	554-492W-5	554-492-8	554-492W-8
20	20	38	20	100	0.75	553-502-5	553-502W-5	553-502-8	553-502W-8
		56	20	150	0.75	554-502-5	554-502W-5	554-502-8	554-502W-8
25	25	38	25	100	0.75	553-512-5	553-512W-5	553-512-8	553-512W-8
		70	25	150	0.75	554-512-5	554-512W-5	554-512-8	554-512W-8

We manufacture a full range of cutting diameters. Please call for availability.
당사는 모든 범위의 커팅 직경을 제조합니다. 전화로 구입할 수 있는지 문의하십시오.

HY5 PRO+ SQUARE ENDMILLS

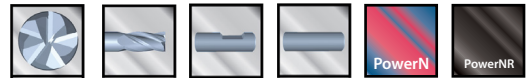

HY5 울트라 스퀘어 엔드밀

5 Flutes	Coated with or without flat	Unique 45° 5 flute design, superior coating and edge quality
5 플루트	플랫 포함 또는 플랫 없이 코팅	고유 45° 5 플루트 디자인, 탁월한 코팅 및 에지 품질

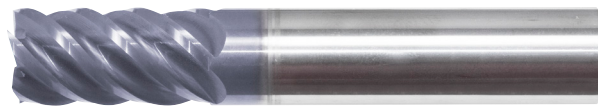
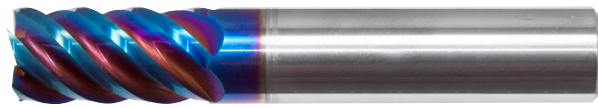
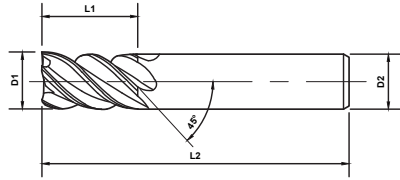

- Stub, Series 558, PowerN
 - Standard, Series 556, PowerN
 - Long, Series 557, PowerN
-
- Stub, Series 558, PowerNR
 - Standard, Series 556, PowerNR
 - Long, Series 557, PowerNR



Length Key (K)

 Standard
 Stub
 Long



K	OD	LOC	SHK	OAL	PowerN		PowerNR	
					No Flat	With Flat	No Flat	With Flat
3	D1	L1	D2	L2	558-002-5	558-002W-5	558-002-8	558-002W-8
		6	3	38	556-002-5	556-002W-5	556-002-8	556-002W-8
		12	3	38	557-002-5	557-002W-5	557-002-8	557-002W-8
4	D1	L1	D2	L2	558-004-5	558-004W-5	558-004-8	558-004W-8
		8	4	50	556-008-5	556-008W-5	556-008-8	556-008W-8
		14	4	50	557-004-5	557-004W-5	557-004-8	557-004W-8
5	D1	L1	D2	L2	558-006-5	558-006W-5	558-006-8	558-006W-8
		10	5	50	556-014-5	556-014W-5	556-014-8	556-014W-8
		16	5	50	557-006-5	557-006W-5	557-006-8	557-006W-8
6	D1	L1	D2	L2	558-008-5	558-008W-5	558-008-8	558-008W-8
		12	6	50	556-018-5	556-018W-5	556-018-8	556-018W-8
		19	6	63	557-008-5	557-008W-5	557-008-8	557-008W-8
8	D1	L1	D2	L2	558-012-5	558-012W-5	558-012-8	558-012W-8
		12	8	50	556-020-5	556-020W-5	556-020-8	556-020W-8
		19	8	63	557-010-5	557-010W-5	557-010-8	557-010W-8
10	D1	L1	D2	L2	558-014-5	558-014W-5	558-014-8	558-014W-8
		14	10	50	556-022-5	556-022W-5	556-022-8	556-022W-8
		22	10	70	557-012-5	557-012W-5	557-012-8	557-012W-8
12	D1	L1	D2	L2	558-016-5	558-016W-5	558-016-8	558-016W-8
		16	12	63	556-024-5	556-024W-5	556-024-8	556-024W-8
		25	12	75	557-014-5	557-014W-5	557-014-8	557-014W-8
14	D1	L1	D2	L2	558-016-5	558-016W-5	558-016-8	558-016W-8
		25	14	88	556-026-5	556-026W-5	556-026-8	556-026W-8
		56	14	125	557-016-5	557-016W-5	557-016-8	557-016W-8
16	D1	L1	D2	L2	558-016-5	558-016W-5	558-016-8	558-016W-8
		32	16	88	556-028-5	556-028W-5	556-028-8	556-028W-8
		56	16	150	557-018-5	557-018W-5	557-018-8	557-018W-8
18	D1	L1	D2	L2	558-018-5	558-018W-5	558-018-8	558-018W-8
		36	18	100	556-030-5	556-030W-5	556-030-8	556-030W-8
		56	18	150	557-020-5	557-020W-5	557-020-8	557-020W-8
20	D1	L1	D2	L2	558-020-5	558-020W-5	558-020-8	558-020W-8
		38	20	100	556-032-5	556-032W-5	556-032-8	556-032W-8
		56	20	150	557-022-5	557-022W-5	557-022-8	557-022W-8
25	D1	L1	D2	L2	558-024-5	558-024W-5	558-024-8	558-024W-8
		38	25	100	556-034-5	556-034W-5	556-034-8	556-034W-8
		70	25	150	557-024-5	557-024W-5	557-024-8	557-024W-8

We manufacture a full range of cutting diameters. Please call for availability.
 당사는 모든 범위의 커팅 직경을 제조합니다. 전화로 구입할 수 있는지 문의하십시오.

HY5 PRO+ CORNER RADIUS

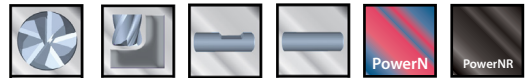

HY5 울트라 코너 반경 엔드밀

5 Flutes 5 플루트	Coated with or without flat 플랫 포함 또는 플랫 없이 코팅	Unique 45° 5 flute design, superior coating and edge quality 고유 45° 5 플루트 디자인, 탁월한 코팅 및 에지 품질
-------------------	--	--

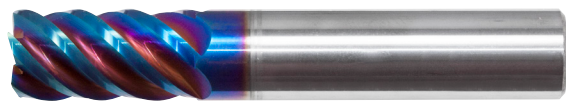
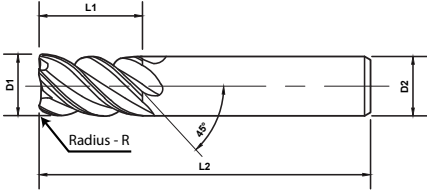

- Stub, Series 558, PowerN
- Standard, Series 556, PowerN
- Long, Series 557, PowerN

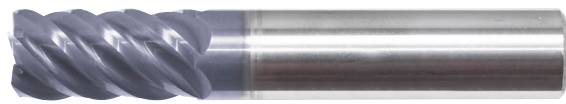

- Stub, Series 558, PowerNR
- Standard, Series 556, PowerNR
- Long, Series 557, PowerNR



Length Key (K)



K	OD	LOC	SHK	OAL	Radius	PowerN		PowerNR					
	D1	L1	D2	L2	R	No Flat	With Flat	No Flat	With Flat				
3	6	3	3	38	0.25	558-401-5	558-401W-5	558-401-8	558-401W-8				
					0.50	558-402-5	558-402W-5	558-402-8	558-402W-8				
					0.75	558-403-5	558-403W-5	558-403-8	558-403W-8				
					1.00	558-404-5	558-404W-5	558-404-8	558-404W-8				
					12	3	3	38	0.25	556-400-5	556-400W-5	556-400-8	556-400W-8
									0.50	556-401-5	556-401W-5	556-401-8	556-401W-8
									0.75	556-402-5	556-402W-5	556-402-8	556-402W-8
									0.25	557-400-5	557-400W-5	557-400-8	557-400W-8
									0.50	557-401-5	557-401W-5	557-401-8	557-401W-8
									0.75	557-402-5	557-402W-5	557-402-8	557-402W-8
									1.00	557-403-5	557-403W-5	557-403-8	557-403W-8
									20	3	3	65	0.25
0.50	558-411-5	558-411W-5	558-411-8	558-411W-8									
0.75	558-412-5	558-412W-5	558-412-8	558-412W-8									
1.00	558-413-5	558-413W-5	558-413-8	558-413W-8									
14	4	4	50	0.25	556-420-5	556-420W-5	556-420-8	556-420W-8					
				0.50	556-421-5	556-421W-5	556-421-8	556-421W-8					
				0.75	556-422-5	556-422W-5	556-422-8	556-422W-8					
				1.00	556-423-5	556-423W-5	556-423-8	556-423W-8					
20	4	4	65	0.25	557-410-5	557-410W-5	557-410-8	557-410W-8					
				0.50	557-411-5	557-411W-5	557-411-8	557-411W-8					
				0.75	557-412-5	557-412W-5	557-412-8	557-412W-8					
				1.00	557-413-5	557-413W-5	557-413-8	557-413W-8					
5	10	5	50	0.25	558-420-5	558-420W-5	558-420-8	558-420W-8					
				0.50	558-421-5	558-421W-5	558-421-8	558-421W-8					
				0.75	558-422-5	558-422W-5	558-422-8	558-422W-8					
				1.00	558-423-5	558-423W-5	558-423-8	558-423W-8					
				16	5	5	50	0.25	556-440-5	556-440W-5	556-440-8	556-440W-8	
								0.50	556-441-5	556-441W-5	556-441-8	556-441W-8	
								0.75	556-442-5	556-442W-5	556-442-8	556-442W-8	
								1.00	556-443-5	556-443W-5	556-443-8	556-443W-8	

We manufacture a full range of cutting diameters. Please call for availability.
당사는 모든 범위의 커팅 직경을 제조합니다. 전화로 구입할 수 있는지 문의하십시오.

HY5 PRO+ CORNER RADIUS

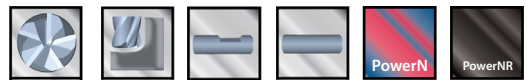

HY5 울트라 코너 반경 엔드밀

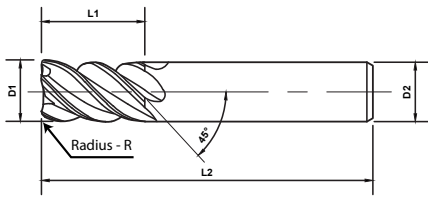

Length Key (K)

Standard Stub Long



K	OD	LOC	SHK	OAL	Radius	PowerN		PowerNR	
	D1	L1	D2	L2	R	No Flat	With Flat	No Flat	With Flat
5	20	20	5	75	0.25	557-420-5	557-420W-5	557-420-8	557-420W-8
		20	5	75	0.50	557-422-5	557-422W-5	557-422-8	557-422W-8
		20	5	75	0.75	557-423-5	557-423W-5	557-423-8	557-423W-8
		20	5	75	1.00	557-424-5	557-424W-5	557-424-8	557-424W-8
6	12	6	50	0.25	558-430-5	558-430W-5	558-430-8	558-430W-8	
		6	50	0.50	558-431-5	558-431W-5	558-431-8	558-431W-8	
		6	50	0.75	558-432-5	558-432W-5	558-432-8	558-432W-8	
		6	50	1.00	558-433-5	558-433W-5	558-433-8	558-433W-8	
		6	50	1.25	558-434-5	558-434W-5	558-434-8	558-434W-8	
		6	50	1.50	558-435-5	558-435W-5	558-435-8	558-435W-8	
		6	50	2.00	558-436-5	558-436W-5	558-436-8	558-436W-8	
		6	63	0.25	556-460-5	556-460W-5	556-460-8	556-460W-8	
		6	63	0.50	556-461-5	556-461W-5	556-461-8	556-461W-8	
		6	63	0.75	556-462-5	556-462W-5	556-462-8	556-462W-8	
		6	63	1.00	556-463-5	556-463W-5	556-463-8	556-463W-8	
		6	63	1.25	556-464-5	556-464W-5	556-464-8	556-464W-8	
8	12	8	50	0.50	558-451-5	558-451W-5	558-451-8	558-451W-8	
		8	50	0.75	558-452-5	558-452W-5	558-452-8	558-452W-8	
		8	50	1.00	558-453-5	558-453W-5	558-453-8	558-453W-8	
		8	50	1.25	558-454-5	558-454W-5	558-454-8	558-454W-8	
		8	50	1.50	558-455-5	558-455W-5	558-455-8	558-455W-8	
		8	50	2.00	558-456-5	558-456W-5	558-456-8	558-456W-8	
		8	50	3.00	558-457-5	558-457W-5	558-457-8	558-457W-8	
		8	63	0.50	556-471-5	556-471W-5	556-471-8	556-471W-8	
		8	63	0.75	556-472-5	556-472W-5	556-472-8	556-472W-8	
		8	63	1.00	556-473-5	556-473W-5	556-473-8	556-473W-8	
		8	63	1.25	556-474-5	556-474W-5	556-474-8	556-474W-8	
		8	63	1.50	556-475-5	556-475W-5	556-475-8	556-475W-8	
8	19	8	63	2.00	556-476-5	556-476W-5	556-476-8	556-476W-8	
		8	63	3.00	556-477-5	556-477W-5	556-477-8	556-477W-8	
		8	75	0.50	557-441-5	557-441W-5	557-441-8	557-441W-8	
		8	75	0.75	557-442-5	557-442W-5	557-442-8	557-442W-8	
		8	75	1.00	557-443-5	557-443W-5	557-443-8	557-443W-8	
		8	75	1.25	557-444-5	557-444W-5	557-444-8	557-444W-8	
		8	75	1.50	557-445-5	557-445W-5	557-445-8	557-445W-8	
		8	75	2.00	557-446-5	557-446W-5	557-446-8	557-446W-8	
		8	75	3.00	557-447-5	557-447W-5	557-447-8	557-447W-8	

We manufacture a full range of cutting diameters. Please call for availability.
당사는 모든 범위의 커팅 직경을 제조합니다. 전화로 구입할 수 있는지 문의하십시오.

HY5 PRO+ CORNER RADIUS

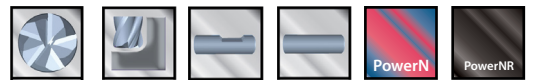

HY5 울트라 코너 반경 엔드밀

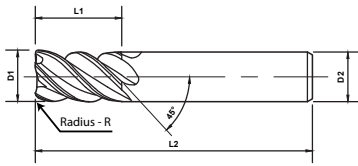

Length Key (K)



K	OD	LOC	SHK	OAL	Radius	PowerN		PowerNR			
	D1	L1	D2	L2	R	No Flat	With Flat	No Flat	With Flat		
10	14	14	10	50	0.50	558-461-5	558-461W-5	558-461-8	558-461W-8		
		14	10	50	0.75	558-462-5	558-462W-5	558-462-8	558-462W-8		
		14	10	50	1.00	558-463-5	558-463W-5	558-463-8	558-463W-8		
		14	10	50	1.25	558-464-5	558-464W-5	558-464-8	558-464W-8		
		14	10	50	1.50	558-465-5	558-465W-5	558-465-8	558-465W-8		
		14	10	50	2.00	558-466-5	558-466W-5	558-466-8	558-466W-8		
	22	10	70	70	0.50	556-481-5	556-481W-5	556-481-8	556-481W-8		
			70	70	0.75	556-482-5	556-482W-5	556-482-8	556-482W-8		
			70	70	1.00	556-483-5	556-483W-5	556-483-8	556-483W-8		
			70	70	1.25	556-484-5	556-484W-5	556-484-8	556-484W-8		
			70	70	1.50	556-485-5	556-485W-5	556-485-8	556-485W-8		
			70	70	2.00	556-486-5	556-486W-5	556-486-8	556-486W-8		
		38	10	100	100	0.50	557-451-5	557-451W-5	557-451-8	557-451W-8	
				100	100	0.75	557-452-5	557-452W-5	557-452-8	557-452W-8	
				100	100	1.00	557-453-5	557-453W-5	557-453-8	557-453W-8	
				100	100	1.25	557-454-5	557-454W-5	557-454-8	557-454W-8	
			38	10	100	100	1.50	557-455-5	557-455W-5	557-455-8	557-455W-8
					100	100	2.00	557-456-5	557-456W-5	557-456-8	557-456W-8
					100	100	3.00	557-457-5	557-457W-5	557-457-8	557-457W-8
					100	100	4.00	557-458-5	557-458W-5	557-458-8	557-458W-8
12	16	12	63	0.50	558-471-5	558-471W-5	558-471-8	558-471W-8			
		12	63	0.75	558-472-5	558-472W-5	558-472-8	558-472W-8			
		12	63	1.00	558-473-5	558-473W-5	558-473-8	558-473W-8			
		12	63	1.25	558-474-5	558-474W-5	558-474-8	558-474W-8			
		12	63	1.50	558-475-5	558-475W-5	558-475-8	558-475W-8			
		12	63	2.00	558-476-5	558-476W-5	558-476-8	558-476W-8			
	25	12	75	75	0.50	556-491-5	556-491W-5	556-491-8	556-491W-8		
			75	75	0.75	556-492-5	556-492W-5	556-492-8	556-492W-8		
			75	75	1.00	556-493-5	556-493W-5	556-493-8	556-493W-8		
			75	75	1.25	556-494-5	556-494W-5	556-494-8	556-494W-8		
		50	12	75	75	1.50	556-495-5	556-495W-5	556-495-8	556-495W-8	
				75	75	2.00	556-496-5	556-496W-5	556-496-8	556-496W-8	
				75	75	3.00	556-497-5	556-497W-5	556-497-8	556-497W-8	
				75	75	4.00	556-498-5	556-498W-5	556-498-8	556-498W-8	
				100	100	0.50	557-461-5	557-461W-5	557-461-8	557-461W-8	
				100	100	0.75	557-462-5	557-462W-5	557-462-8	557-462W-8	
			50	12	100	100	1.00	557-463-5	557-463W-5	557-463-8	557-463W-8
					100	100	1.25	557-464-5	557-464W-5	557-464-8	557-464W-8
					100	100	1.50	557-465-5	557-465W-5	557-465-8	557-465W-8
					100	100	2.00	557-466-5	557-466W-5	557-466-8	557-466W-8
100	100	3.00			557-467-5	557-467W-5	557-467-8	557-467W-8			
100	100	4.00			557-468-5	557-468W-5	557-468-8	557-468W-8			

We manufacture a full range of cutting diameters. Please call for availability.
 당사는 모든 범위의 커팅 직경을 제조합니다. 전화로 구입할 수 있는지 문의하십시오.



HY5 PRO+ CORNER RADIUS

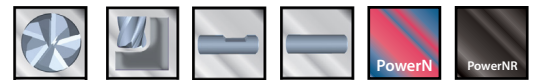

HY5 울트라 코너 반경 엔드밀

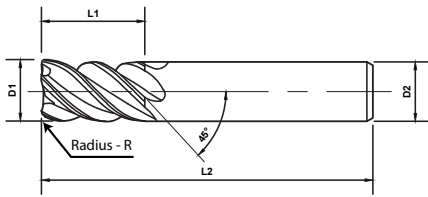

Length Key (K)

Standard Stub Long



K	OD	LOC	SHK	OAL	Radius	PowerN		PowerNR					
	D1	L1	D2	L2	R	No Flat	With Flat	No Flat	With Flat				
14	25	14	14	88	0.50	556-501-5	556-501W-5	556-501-8	556-501W-8				
					0.75	556-502-5	556-502W-5	556-502-8	556-502W-8				
					1.00	556-503-5	556-503W-5	556-503-8	556-503W-8				
					1.50	556-505-5	556-505W-5	556-505-8	556-505W-8				
					2.00	556-506-5	556-506W-5	556-506-8	556-506W-8				
					3.00	556-507-5	556-507W-5	556-507-8	556-507W-8				
					4.00	556-508-5	556-508W-5	556-508-8	556-508W-8				
					56	14	125	125	0.50	557-471-5	557-471W-5	557-471-8	557-471W-8
									0.75	557-472-5	557-472W-5	557-472-8	557-472W-8
									1.00	557-473-5	557-473W-5	557-473-8	557-473W-8
									1.50	557-475-5	557-475W-5	557-475-8	557-475W-8
									2.00	557-476-5	557-476W-5	557-476-8	557-476W-8
									3.00	557-477-5	557-477W-5	557-477-8	557-477W-8
									4.00	557-478-5	557-478W-5	557-478-8	557-478W-8
16	32	16	16	88	0.50	556-511-5	556-511W-5	556-511-8	556-511W-8				
					0.75	556-512-5	556-512W-5	556-512-8	556-512W-8				
					1.00	556-513-5	556-513W-5	556-513-8	556-513W-8				
					1.50	556-515-5	556-515W-5	556-515-8	556-515W-8				
					2.00	556-516-5	556-516W-5	556-516-8	556-516W-8				
					3.00	556-517-5	556-517W-5	556-517-8	556-517W-8				
					4.00	556-518-5	556-518W-5	556-518-8	556-518W-8				
					56	16	150	150	0.50	557-481-5	557-481W-5	557-481-8	557-481W-8
									0.75	557-482-5	557-482W-5	557-482-8	557-482W-8
									1.00	557-483-5	557-483W-5	557-483-8	557-483W-8
									1.50	557-485-5	557-485W-5	557-485-8	557-485W-8
									2.00	557-486-5	557-486W-5	557-486-8	557-486W-8
									3.00	557-487-5	557-487W-5	557-487-8	557-487W-8
									4.00	557-488-5	557-488W-5	557-488-8	557-488W-8
18	36	18	18	100	0.50	556-521-5	556-521W-5	556-521-8	556-521W-8				
					0.75	556-522-5	556-522W-5	556-522-8	556-522W-8				
					1.00	556-523-5	556-523W-5	556-523-8	556-523W-8				
					1.50	556-525-5	556-525W-5	556-525-8	556-525W-8				
					2.00	556-526-5	556-526W-5	556-526-8	556-526W-8				
					3.00	556-527-5	556-527W-5	556-527-8	556-527W-8				
					4.00	556-528-5	556-528W-5	556-528-8	556-528W-8				
					56	18	150	150	0.50	557-491-5	557-491W-5	557-491-8	557-491W-8
									0.75	557-492-5	557-492W-5	557-492-8	557-492W-8
									1.00	557-493-5	557-493W-5	557-493-8	557-493W-8
									1.50	557-495-5	557-495W-5	557-495-8	557-495W-8
									2.00	557-496-5	557-496W-5	557-496-8	557-496W-8
									3.00	557-497-5	557-497W-5	557-497-8	557-497W-8
									4.00	557-498-5	557-498W-5	557-498-8	557-498W-8

We manufacture a full range of cutting diameters. Please call for availability.
당사는 모든 범위의 커팅 직경을 제조합니다. 전화로 구입할 수 있는지 문의하십시오.

HY5 PRO+ CORNER RADIUS

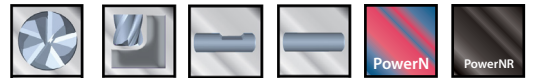

HY5 울트라 코너 반경 엔드밀

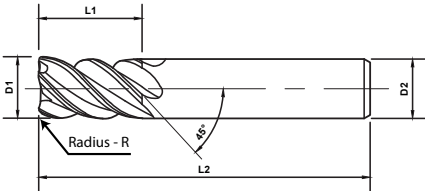

PRO+ PERFORMANCE ENDMILLS

Length Key (K)

Standard
Stub
Long



K	OD	LOC	SHK	OAL	Radius	PowerN		PowerNR						
	D1	L1	D2	L2	R	No Flat	With Flat	No Flat	With Flat					
20	38	20	20	100	0.50	556-531-5	556-531W-5	556-531-8	556-531W-8					
					0.75	556-532-5	556-532W-5	556-532-8	556-532W-8					
					1.00	556-533-5	556-533W-5	556-533-8	556-533W-8					
					1.50	556-535-5	556-535W-5	556-535-8	556-535W-8					
					2.00	556-536-5	556-536W-5	556-536-8	556-536W-8					
					3.00	556-537-5	556-537W-5	556-537-8	556-537W-8					
					4.00	556-538-5	556-538W-5	556-538-8	556-538W-8					
					5.00	556-539-5	556-539W-5	556-539-8	556-539W-8					
					56	20	150	0.50	150	0.50	557-501-5	557-501W-5	557-501-8	557-501W-8
										0.75	557-502-5	557-502W-5	557-502-8	557-502W-8
										1.00	557-503-5	557-503W-5	557-503-8	557-503W-8
										1.50	557-505-5	557-505W-5	557-505-8	557-505W-8
										2.00	557-506-5	557-506W-5	557-506-8	557-506W-8
										3.00	557-507-5	557-507W-5	557-507-8	557-507W-8
										4.00	557-508-5	557-508W-5	557-508-8	557-508W-8
										5.00	557-509-5	557-509W-5	557-509-8	557-509W-8
25	38	25	25	100	0.50	556-541-5	556-541W-5	556-541-8	556-541W-8					
					0.75	556-542-5	556-542W-5	556-542-8	556-542W-8					
					1.00	556-543-5	556-543W-5	556-543-8	556-543W-8					
					1.50	556-545-5	556-545W-5	556-545-8	556-545W-8					
					2.00	556-546-5	556-546W-5	556-546-8	556-546W-8					
					3.00	556-547-5	556-547W-5	556-547-8	556-547W-8					
					4.00	556-548-5	556-548W-5	556-548-8	556-548W-8					
					5.00	556-549-5	556-549W-5	556-549-8	556-549W-8					
					70	25	150	0.50	150	0.50	557-511-5	557-511W-5	557-511-8	557-511W-8
										0.75	557-512-5	557-512W-5	557-512-8	557-512W-8
										1.00	557-513-5	557-513W-5	557-513-8	557-513W-8
										1.50	557-515-5	557-515W-5	557-515-8	557-515W-8
										2.00	557-516-5	557-516W-5	557-516-8	557-516W-8
										3.00	557-517-5	557-517W-5	557-517-8	557-517W-8
										4.00	557-518-5	557-518W-5	557-518-8	557-518W-8
										5.00	557-519-5	557-519W-5	557-519-8	557-519W-8

We manufacture a full range of cutting diameters. Please call for availability.
 당사는 모든 범위의 커팅 직경을 제조합니다. 전화로 구입할 수 있는지 문의하십시오.

F45 PRO+ SQUARE ENDMILLS

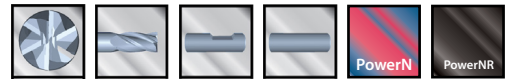

F45 울트라 스퀘어 엔드밀

6 Flutes	Coated	Unique 45° 6 flute design, superior coating and edge quality
6 플루트	코팅	고유 45° 6 플루트 디자인, 탁월한 코팅 및 에지 품질

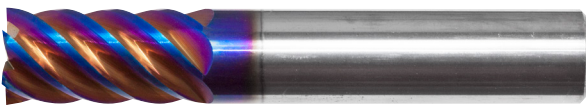
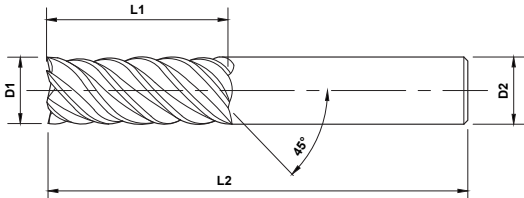

Standard, Series 559, PowerN

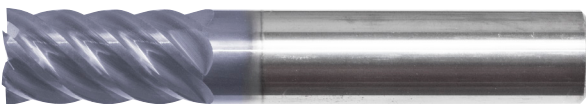

Standard, Series 559, PowerNR

Length Key (K)

Standard Stub Long



	OD	LOC	SHK	OAL	PowerN	PowerNR
K	D1	L1	D2	L2		
	5	16	5	50	559-002-5	559-002-8
	6	19	6	63	559-004-5	559-004-8
	7	19	8	63	559-006-5	559-006-8
	8	21	8	63	559-008-5	559-008-8
	9	22	10	70	559-010-5	559-010-8
	10	25	10	70	559-012-5	559-012-8
	11	25	11	70	559-014-5	559-014-8
	12	25	12	75	559-016-5	559-016-8
	14	30	14	88	559-018-5	559-018-8
	16	32	16	88	559-020-5	559-020-8
	18	35	18	100	559-022-5	559-022-8
	20	38	20	100	559-024-5	559-024-8
	22	38	22	100	559-026-5	559-026-8
	25	38	25	100	559-028-5	559-028-8

We manufacture a full range of cutting diameters. Please call for availability.
당사는 모든 범위의 커팅 직경을 제조합니다. 전화로 구입할 수 있는지 문의하십시오.

F45 PRO+ CORNER RADIUS

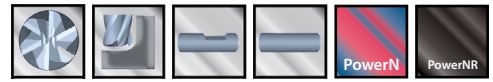

F45 울트라 코너 반경

6 Flutes	Coated	Unique 45° 6 flute design, superior coating and edge quality
6 플루트	코팅	고유 45° 6 플루트 디자인, 탁월한 코팅 및 에지 품질

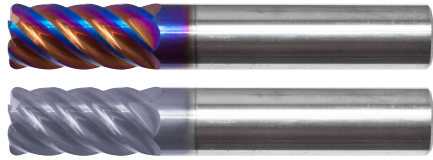

Standard, Series 559, PowerN

Standard, Series 559, PowerNR

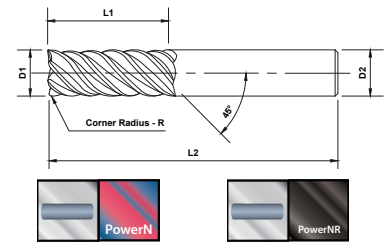

	OD	LOC	SHK	OAL	Radius	PowerN	PowerNR
K	D1	L1	D2	L2	R		
	6	19	6	63	0.25	559-210-5	559-210-8
	7	19	8	63	0.25	559-220-5	559-220-8
	8	21	8	63	0.25	559-230-5	559-230-8
	9	22	10	70	0.50	559-241-5	559-241-8
	10	25	10	70	0.50	559-251-5	559-251-8
	11	25	11	70	0.50	559-261-5	559-261-8
	12	25	12	75	0.50	559-271-5	559-271-8
	14	30	14	88	0.50	559-281-5	559-281-8
	16	32	16	88	0.50	559-291-5	559-291-8
	18	35	18	100	1.00	559-303-5	559-303-8
	20	38	20	100	1.00	559-313-5	559-313-8
	22	38	22	100	1.00	559-323-5	559-323-8
	25	38	25	100	1.25	559-334-5	559-334-8

We manufacture a full range of cutting diameters. Please call for availability. 당사는 모든 범위의 커팅 직경을 제조합니다. 전화로 구입할 수 있는지 문의하십시오.

PRO+ PERFORMANCE ENDMILLS

V7 PRO+ ENDMILLS

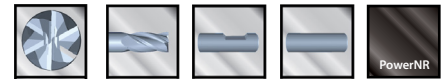

V7 울트라

7 Flutes	Coated	Progressive Helix	Non-Center Cutting Design
7 플루트	코팅	프로그레시브 나선	비 중심 절단 설계

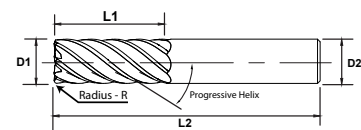

Standard, Series 449, PowerNR



	OD	LOC	SHK	OAL	Square	.50mm Corner Radius	1mm Corner Radius	2mm Corner Radius	3mm Corner Radius	4mm Corner Radius
K	D1	L1	D2	L2						
	6	13	6	57	549-006-8	549-421-8	549-423-8	549-426-8	-	-
	8	19	8	63	549-014-8	549-461-8	549-463-8	549-466-8	549-467-8	-
	10	19	10	63	549-020-8	549-491-8	549-493-8	549-496-8	549-497-8	549-498-8
	12	32	12	84	549-034-8	549-561-8	549-563-8	549-566-8	549-567-8	549-568-8
	16	42	16	92	549-046-8	549-621-8	549-623-8	549-626-8	549-627-8	549-628-8
	20	52	20	102	549-054-8	549-661-8	549-663-8	549-666-8	549-667-8	549-668-8

Available with Weldon Flat - Add **W** to part ID for Weldon flat 449-XXXW-8

CARBIDE DRILLS

카바이드 드릴

- **Jobber Drills** - 자버 드릴
- **Stub Drills** - 스텝 드릴
- **Straight Flute Drills** - 스트레이트 플루트 드릴
- **Spade Drills** - 스페이드 드릴
- **Spotting Drills** - 스포팅 드릴
- **Drill and Countersink** - 드릴 및 카운터싱크
- **Multiple Flute Countersinks** - 멀티 플루트 카운터싱크
- **Chamfer Tools** - 챔퍼 공구

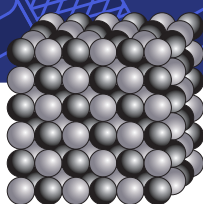

Mastercut's Superior Carbide Blend A-Gr-SiV (Active Grain Sized Volume)

Our superior tungsten carbide gives you the ability to be *aggressive* when you need to be. Growth inhibitors in our submicron carbide blanks maintain the most consistent grain size available, giving you superior hardness AND toughness.



Mastercut의 탁월한 카바이드 혼합 - A-Gr-SiV(액티브 결정 입도 볼륨)

당사의 우수한 텅스텐 카바이드는 귀하가 필요할 때 공격적으로 대응할 수 있는 능력을 제공합니다. 당사의 서브 마이크론 카바이드 블랭크의 성장 억제제는 가장 균일한 결정 입도를 유지하며, 탁월한 경도와 인성을 제공합니다.

LEGEND

범례

Features • 기능

	2 Flutes 2 플루트		4 Flutes 4 플루트		Plain Shank 플레인 샹크
	3 Flutes 3 플루트		6 Flutes 6 플루트		

Coatings • 코팅

	PowerA PowerA (Aluminum Titanium Nitride - AlTiN)		Uncoated 비코팅
---	---	---	-----------------

















































































Mastercut's Superior Carbide Blend – A-Gr-SiV (Active Grain Sized Volume)

Our superior tungsten carbide gives you the ability to be **aggressive** when you need to be. Growth inhibitors in our submicron carbide blanks maintain the most consistent grain size available, giving you superior hardness and toughness.

Mastercut의 탁월한 카바이드 혼합 – A-Gr-SiV(액티브 결정 입도 볼륨)

당사의 우수한 텅스텐 카바이드는 귀하가 필요할 때 공격적으로 대응할 수 있는 능력을 제공합니다. 당사의 서브 마이크론 카바이드 블랭크의 성장 억제제는 가장 균일한 결정 입도를 유지하며, 탁월한 경도와 인성을 제공합니다.

TABLE OF CONTENTS - 목차

	2 Flute Jobber Drills 2 플루트 자버 드릴.....	107							
	3 Flute Jobber Drills 3 플루트 자버 드릴.....	108							
	Stub Drills 스텝 드릴.....	110							
	Medium Length Drills 중간 길이 드릴.....	111							
	Spade Drills 스페이드 드릴.....	113							
	NC Spotting Drills NC 스폿팅 드릴.....	114							
	Drill and Countersink / Center Drills 드릴 및 카운터싱크/센터 드릴.....	115							
	Countersinks, 1 Flute 카운터싱크, 1 플루트.....	116							
	Countersinks, 3 Flute 카운터싱크, 3 플루트.....	117							
	Countersinks, 6 Flute 카운터싱크, 6 플루트.....	118							
	Chamfer Tools 챔퍼 공구.....	119							

JOBBER DRILLS

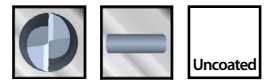

자버 드릴 - 2 플루트



2 Flute	118° Four Facet Point	Uncoated
2 플루트	118° 4 패킷 포인트	비코팅

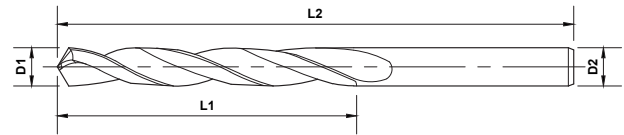

OD	LOC	SHK	OAL	Uncoated
D1	L1	D2	L2	
3	33	3	61	701-006
3.1	36	3.1	65	701-008
3.2	36	3.2	65	701-010
3.3	36	3.3	65	701-012
3.4	39	3.4	70	701-014
3.5	39	3.5	70	701-016
3.6	39	3.6	70	701-018
3.7	39	3.7	70	701-020
3.8	43	3.8	75	701-022
3.9	43	3.9	75	701-024
4	43	4	75	701-026
4.1	43	4.1	75	701-028
4.2	43	4.2	75	701-030
4.3	47	4.3	80	701-032
4.4	47	4.4	80	701-034
4.5	47	4.5	80	701-036
4.6	47	4.6	80	701-038
4.7	47	4.7	80	701-040
4.8	52	4.8	86	701-042
4.9	52	4.9	86	701-044
5	52	5	86	701-046
5.1	52	5.1	86	701-048
5.2	52	5.2	86	701-050
5.3	52	5.3	86	701-052
5.4	57	5.4	93	701-054
5.5	57	5.5	93	701-056
5.6	57	5.6	93	701-058
5.7	57	5.7	93	701-060
5.8	57	5.8	93	701-062
5.9	57	5.9	93	701-064
6	57	6	93	701-066
6.1	63	6.1	101	701-068
6.2	63	6.2	101	701-070
6.3	63	6.3	101	701-072
6.4	63	6.4	101	701-074
6.5	63	6.5	101	701-076
6.6	63	6.6	101	701-078
6.7	63	6.7	101	701-080
6.8	69	6.8	109	701-082
6.9	69	6.9	109	701-084

OD	LOC	SHK	OAL	Uncoated
D1	L1	D2	L2	
7	69	7	109	701-086
7.1	69	7.1	109	701-088
7.2	69	7.2	109	701-090
7.3	69	7.3	109	701-092
7.4	69	7.4	109	701-094
7.5	69	7.5	109	701-096
7.6	75	7.6	117	701-098
7.7	75	7.7	117	701-100
7.8	75	7.8	117	701-102
7.9	75	7.9	117	701-104
8	75	8	117	701-106
8.1	75	8.1	117	701-108
8.2	75	8.2	117	701-110
8.3	75	8.3	117	701-112
8.4	75	8.4	117	701-114
8.5	75	8.5	117	701-116
8.6	81	8.6	125	701-118
8.7	81	8.7	125	701-120
8.8	81	8.8	125	701-122
8.9	81	8.9	125	701-124
9	81	9	125	701-126
9.1	81	9.1	125	701-128
9.2	81	9.2	125	701-130
9.3	81	9.3	125	701-132
9.4	81	9.4	125	701-134
9.5	81	9.5	125	701-136
9.6	87	9.6	133	701-138
9.7	87	9.7	133	701-140
9.8	87	9.8	133	701-142
9.9	87	9.9	133	701-144
10	87	10	133	701-146
10.2	87	10.2	133	701-148
10.5	87	10.5	133	701-150
11	94	11	142	701-152
11.5	94	11.5	142	701-154
12	101	12	151	701-156
14.5	114	14.5	169	701-158
15	114	15	169	701-160
15.5	120	15.5	178	701-162

CARBIDE DRILLS

3 FLUTE JOBBER DRILLS

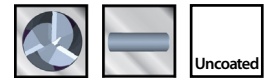

자버 드릴 - 3 플루트

3 Flute	130° Four Facet Point	Uncoated
3 플루트	130° 4 패시트 포인트	비코팅

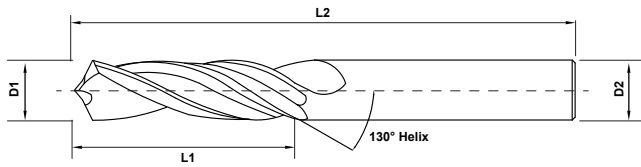

OD	LOC	SHK	OAL	Uncoated
D1	L1	D2	L2	
4	22	4	55	701-502
4.1	22	4.1	55	701-504
4.2	22	4.2	55	701-506
4.3	24	4.3	58	701-508
4.4	24	4.4	58	701-510
4.5	24	4.5	58	701-512
4.6	24	4.6	58	701-514
4.7	24	4.7	58	701-516
4.8	26	4.8	62	701-518
4.9	26	4.9	62	701-520
5	26	5	62	701-522
5.1	26	5.1	62	701-524
5.2	26	5.2	62	701-526
5.3	28	5.3	66	701-528
5.4	28	5.4	66	701-530
5.5	28	5.5	66	701-532
5.6	28	5.6	66	701-534
5.7	28	5.7	66	701-536
5.8	28	5.8	66	701-538
5.9	28	5.9	66	701-540
6	31	6	66	701-542
6.1	31	6.1	70	701-544
6.2	31	6.2	70	701-546
6.3	31	6.3	70	701-548
6.4	31	6.4	70	701-550



OD	LOC	SHK	OAL	Uncoated
D1	L1	D2	L2	
6.5	31	6.5	70	701-552
6.6	31	6.6	70	701-554
6.7	31	6.7	70	701-556
6.8	34	6.8	74	701-558
6.9	34	6.9	74	701-560
7	34	7	74	701-562
7.1	34	7.1	74	701-564
7.2	34	7.2	74	701-566
7.3	34	7.3	74	701-568
7.4	34	7.4	74	701-570
7.5	34	7.5	74	701-572
7.6	37	7.6	79	701-574
7.7	37	7.7	79	701-576
7.8	37	7.8	79	701-578
7.9	37	7.9	79	701-580
8	37	8	79	701-582
8.1	37	8.1	79	701-584
8.2	37	8.2	79	701-586
8.3	37	8.3	79	701-588
8.4	37	8.4	79	701-590
8.5	37	8.5	79	701-592
8.6	40	8.6	84	701-594
8.7	40	8.7	84	701-596
8.8	40	8.8	84	701-598
8.9	40	8.9	84	701-600

3 FLUTE JOBBER DRILLS

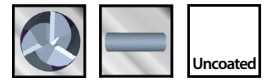

자버 드릴 - 3 플루트



CARBIDE DRILLS



OD	LOC	SHK	OAL	Uncoated
D1	L1	D2	L2	
9	40	9	84	701-602
9.1	40	9.1	84	701-604
9.2	40	9.2	84	701-606
9.3	40	9.3	84	701-608
9.4	40	9.4	84	701-610
9.5	40	9.5	84	701-612
9.6	43	9.6	89	701-614
9.7	43	9.7	89	701-616
9.8	43	9.8	89	701-618
9.9	43	9.9	89	701-620
10	43	10	89	701-622
10.1	43	10.1	89	701-624
10.2	43	10.2	89	701-626
10.3	43	10.3	89	701-628
10.4	43	10.4	89	701-630
10.5	43	10.5	89	701-632
10.6	43	10.6	89	701-634
10.7	43	10.7	89	701-636
10.8	43	10.8	89	701-638
11	47	11	95	701-640

OD	LOC	SHK	OAL	Uncoated
D1	L1	D2	L2	
11.2	47	11.2	95	701-642
11.5	47	11.5	95	701-644
11.8	47	11.8	95	701-646
12	51	12	102	701-648
12.5	51	12.5	102	701-650
13	51	13	102	701-652
13.5	51	13.5	102	701-654
14	54	14	107	701-656
14.5	56	14.5	111	701-658
15	56	15	111	701-660
15.5	58	15.5	115	701-662
16	58	16	115	701-664
16.5	60	16.5	119	701-666
17	60	17	119	701-668
17.5	62	17.5	123	701-670
18	62	18	123	701-672
18.5	64	18.5	127	701-674
19	64	19	127	701-676
19.5	66	19.5	131	701-678
20	66	20	131	701-680

STUB DRILLS

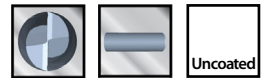

스텝 드릴

2 Flute	118° Four Facet Point	Uncoated
2 플루트	118° 4 패싯 포인트	비코팅

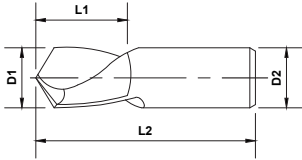

Uncoated



OD	LOC	SHK	OAL	Uncoated
D1	L1	D2	L2	
3	12	3	46	703-002
3.1	14	3.1	49	703-004
3.2	14	3.2	49	703-006
3.3	14	3.3	49	703-008
3.4	15	3.4	52	703-010
3.5	15	3.5	52	703-012
3.6	15	3.6	52	703-014
3.7	15	3.7	52	703-016
3.8	17	3.8	55	703-018
3.9	17	3.9	55	703-020
4	17	4	55	703-022
4.1	17	4.1	55	703-024
4.2	17	4.2	55	703-026
4.3	18	4.3	58	703-028
4.4	18	4.4	58	703-030
4.5	18	4.5	58	703-032
4.6	18	4.6	58	703-034
4.7	18	4.7	58	703-036
4.8	20	4.8	62	703-038
4.9	20	4.9	62	703-040
5	20	5	62	703-042
5.1	20	5.1	62	703-044
5.2	20	5.2	62	703-046
5.3	20	5.3	62	703-048
5.4	21	5.4	66	703-050
5.5	21	5.5	66	703-052
5.6	21	5.6	66	703-054

OD	LOC	SHK	OAL	Uncoated
D1	L1	D2	L2	
5.7	21	5.7	66	703-056
5.8	21	5.8	66	703-058
5.9	21	5.9	66	703-060
6	21	6	66	703-062
6.1	23	6.1	70	703-064
6.2	23	6.2	70	703-066
6.3	23	6.3	70	703-068
6.4	23	6.4	70	703-070
6.5	23	6.5	70	703-072
6.8	23	6.8	70	703-074
6.9	23	6.9	70	703-076
7	25	7	74	703-078
7.5	25	7.5	74	703-080
8	27	8	79	703-082
8.5	27	8.5	79	703-084
9	29	9	84	703-086
9.5	29	9.5	84	703-088
9.6	29	9.6	84	703-090
10	31	10	89	703-092
10.5	31	10.5	89	703-094
11	33	11	95	703-096
11.5	33	11.5	95	703-098
12	35	12	102	703-100
12.5	35	12.5	102	703-102
13	35	13	102	703-104
14	37	14	107	703-106

MEDIUM LENGTH DRILLS

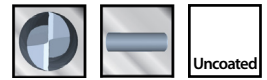

중간 길이 드릴

2 Flute	118° Four Facet Point	Uncoated
2 플루트	118° 4 패싯 포인트	비코팅

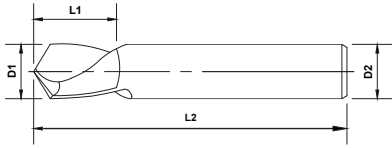

Uncoated



OD	LOC	SHK	OAL	Uncoated
D1	L1	D2	L2	
3	16	3	46	703-502
3.1	16	3.1	46	703-504
3.2	18	3.2	49	703-506
3.3	18	3.3	49	703-508
3.4	20	3.4	52	703-510
3.5	20	3.5	52	703-512
3.6	20	3.6	52	703-514
3.7	20	3.7	52	703-516
3.8	22	3.8	55	703-518
3.9	22	3.9	55	703-520
4	22	4	55	703-522
4.1	22	4.1	55	703-524
4.2	22	4.2	55	703-526
4.3	24	4.3	58	703-528
4.4	24	4.4	58	703-530
4.5	24	4.5	58	703-532
4.6	24	4.6	58	703-534
4.7	24	4.7	58	703-536
4.8	26	4.8	62	703-538
4.9	26	4.9	62	703-540
5	26	5	62	703-542
5.1	26	5.1	62	703-544
5.2	26	5.2	62	703-546
5.3	26	5.3	62	703-548



OD	LOC	SHK	OAL	Uncoated
D1	L1	D2	L2	
5.4	28	5.4	66	703-550
5.5	28	5.5	66	703-552
5.6	28	5.6	66	703-554
5.7	28	5.7	66	703-556
5.8	28	5.8	66	703-558
5.9	28	5.9	66	703-560
6	28	6	66	703-562
6.1	31	6.1	70	703-564
6.2	31	6.2	70	703-566
6.3	31	6.3	70	703-568
6.4	31	6.4	70	703-570
6.5	31	6.5	70	703-572
6.6	31	6.6	70	703-574
6.7	31	6.7	70	703-576
6.8	34	6.8	74	703-578
6.9	34	6.9	74	703-580
7	34	7	74	703-582
7.1	34	7.1	74	703-584
7.2	34	7.2	74	703-586
7.3	34	7.3	74	703-588
7.4	34	7.4	74	703-590
7.5	34	7.5	74	703-592
7.6	37	7.6	79	703-594
7.7	37	7.7	79	703-596

MEDIUM LENGTH DRILLS

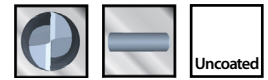

중간 길이 드릴



OD	LOC	SHK	OAL	Uncoated
D1	L1	D2	L2	
7.8	37	7.8	79	703-598
7.9	37	7.9	79	703-600
8	37	8	79	703-602
8.1	37	8.1	79	703-604
8.2	37	8.2	79	703-606
8.3	37	8.3	79	703-608
8.4	37	8.4	79	703-610
8.5	37	8.5	79	703-612
8.6	40	8.6	84	703-614
8.7	40	8.7	84	703-616
8.8	40	8.8	84	703-618
8.9	40	8.9	84	703-620
9	40	9	84	703-622
9.1	40	9.1	84	703-624
9.2	40	9.2	84	703-626
9.3	40	9.3	84	703-628
9.4	40	9.4	84	703-630
9.5	40	9.5	84	703-632
9.6	43	9.6	89	703-634
9.7	43	9.7	89	703-636
9.8	43	9.8	89	703-638
9.9	43	9.9	89	703-640
10	43	10	89	703-642
10.1	43	10.1	89	703-644
10.2	43	10.2	89	703-646
10.3	43	10.3	89	703-648



OD	LOC	SHK	OAL	Uncoated
D1	L1	D2	L2	
10.4	43	10.4	89	703-650
10.5	43	10.5	89	703-652
10.6	43	10.6	89	703-654
10.7	43	10.7	89	703-656
10.8	43	10.8	89	703-658
11	47	11	95	703-660
11.2	47	11.2	95	703-662
11.5	47	11.5	95	703-664
11.8	47	11.8	95	703-666
12	51	12	102	703-668
12.5	51	12.5	102	703-670
13	51	13	102	703-672
13.5	51	13.5	102	703-674
14	56	14	111	703-676
14.5	56	14.5	111	703-678
15	56	15	111	703-680
15.5	58	15.5	115	703-682
16	58	16	115	703-684
16.5	60	16.5	119	703-686
17	60	17	119	703-688
17.5	62	17.5	123	703-690
18	62	18	123	703-692
18.5	64	18.5	127	703-694
19	64	19	127	703-696
19.5	66	19.5	131	703-698
20	66	20	131	703-700

SPADE DRILLS

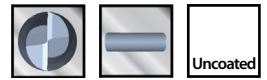

스페이드 드릴

2 Flute	118° Point	Uncoated
2 플루트	118° 포인트	비코팅

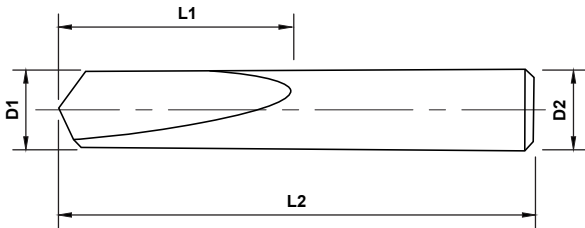

Uncoated

CARBIDE DRILLS

OD	LOC	SHK	OAL	Uncoated
D1	L1	D2	L2	
3	12	3	38	700-002
4	17	4	50	700-004
6	16	6	50	700-006
8	22	8	63	700-008
10	28	10	63	700-010
12	32	12	75	700-012

NC SPOTTING DRILLS

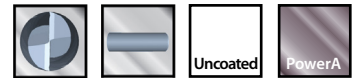

NC 스포팅 드릴

2 Flute	90°, 120° point	Coated and Uncoated
2 플루트	90°, 120° 포인트	코팅 및 비코팅

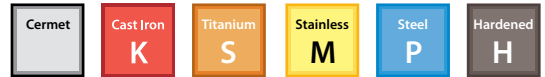
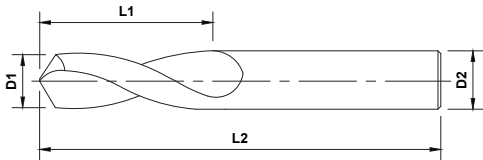

Uncoated



OD	LOC	SHK	OAL	Uncoated		PowerA	
				90°	120°	90°	120°
D1	L1	D2	L2				
3	10	3	38	700-402	700-502	700-402-1	700-502-1
4	18	4	63	700-404	700-504	700-404-1	700-504-1
6	20	6	63	700-406	700-506	700-406-1	700-506-1
8	20	8	63	700-408	700-510	700-408-1	700-510-1
10	25	10	75	700-410	700-512	700-410-1	700-512-1
12	25	12	75	700-412	700-514	700-412-1	700-514-1

DRILL AND COUNTERSINK

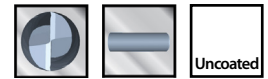

드릴 및 카운터싱크

2 Flute	118° point Center Drills • 60°, 82° and 90° Countersink	Uncoated
2 플루트	118° 포인트 센터 드릴 • 60°, 82° 및 90° 카운터싱크	비코팅

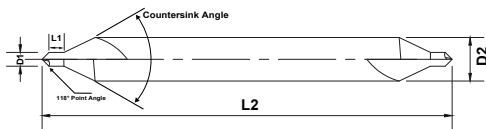

CARBIDE DRILLS



Uncoated

Quick Ship Items

OD	LOC	SHK	OAL	Uncoated		
D1	L1	D2	L2	60°	82°	90°
1.2	1.2	3.18	38	700-302	700-102	700-202
2	2	4.75	50	700-304	700-104	700-204
2.8	2.8	6.3	50	700-306	700-106	700-206
3.15	3.15	8	56	700-308	700-108	700-208
4	4	11.1	70	700-310	700-110	700-210
5	5	12.7	75	700-312	700-112	700-212
6	6	15.9	81	700-314	700-114	700-214
8	8	19	85	700-316	700-116	700-216

COUNTERSINKS - 1 FLUTE

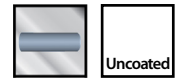

카운터싱크 - 1 플루트

1 Flute	60°, 82° and 90° countersinks	Uncoated
1 플루트	60°, 82° 및 90° 카운터싱크	비코팅

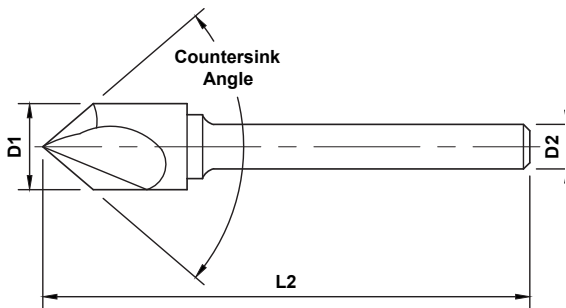

Uncoated

OD	SHK	OAL	Uncoated		
			60°	82°	90°
D1	D2	L2			
3	3	38	780-002 *	780-102 *	780-202 *
5	5	50	780-004 *	780-104 *	780-204 *
6	6	50	780-006 *	780-106 *	780-206 *
9.5	6	66	780-008	780-108	780-208
12.7	6	72	780-010	780-110	780-210
16	8	75	780-012	780-112	780-212
19	8	75	780-014	780-114	780-214
25	8	83	780-016	780-116	780-216

* Solid Carbide • *솔리드 카바이드

COUNTERSINKS - 3 FLUTE

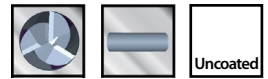

카운터싱크 - 3 플루트

3 Flute	60°, 82° and 90° countersinks	Uncoated
3 플루트	60°, 82° 및 90° 카운터싱크	비코팅

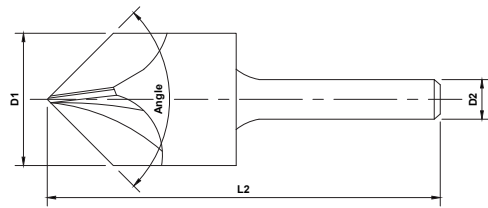

Uncoated

OD	SHK	OAL	Uncoated		
			60°	82°	90°
D1	D2	L2			
3	3	38	780-302 *	780-402 *	780-502 *
5	5	50	780-304 *	780-404 *	780-504 *
6	6	50	780-306 *	780-406 *	780-506 *
9.5	6	66	780-308	780-408	780-508
12.7	6	72	780-310	780-410	780-510
16	8	69	780-312	780-412	780-512
19	8	75	780-314	780-414	780-514
25	8	70	780-316	780-416	780-516

* Solid Carbide * 솔리드 카바이드

COUNTERSINKS - 6 FLUTE

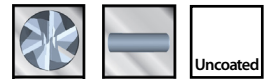

카운터싱크 - 6 플루트

6 Flute	60°, 82° and 90° countersinks	Uncoated
6 플루트	60°, 82° 및 90° 카운터싱크	비코팅

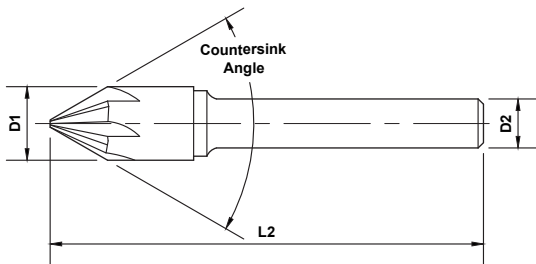

Uncoated



OD	SHK	OAL	Uncoated		
			60°	82°	90°
D1	D2	L2			
3	3	38	780-602 *	780-702 *	780-802 *
5	5	50	780-604 *	780-704 *	780-804 *
6	6	50	780-606 *	780-706 *	780-806 *
9.5	6	66	780-608	780-708	780-808
12.7	6	72	780-610	780-710	780-810
16	8	75	780-612	780-712	780-812
19	8	75	780-614	780-714	780-814
25	8	83	780-616	780-716	780-816

* Solid Carbide • *슬리드 카바이드

CHAMFER TOOLS

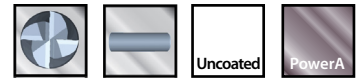

챔퍼 공구

4 Flute	60°, 82° and 90°	Coated and Uncoated
4 플루트	60°, 82° 및 90°	코팅 및 비코팅

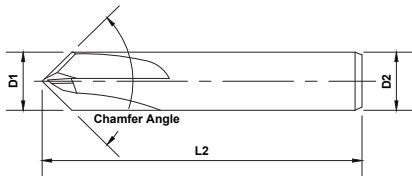

Uncoated

OD	SHK	OAL	Uncoated			PowerA		
			60°	82°	90°	60°	82°	90°
4	4	50	781-002	781-102	781-202	781-002-1	781-102-1	781-202-1
5	5	50	781-004	781-104	781-204	781-004-1	781-104-1	781-204-1
6	6	64	781-006	781-106	781-206	781-006-1	781-106-1	781-206-1
8	8	64	781-008	781-108	781-208	781-008-1	781-108-1	781-208-1
10	10	70	781-010	781-110	781-210	781-010-1	781-110-1	781-210-1
12	12	76	781-012	781-112	781-212	781-012-1	781-112-1	781-212-1

HIGH PERFORMANCE DRILLS

고성능 드릴

Hurricane Drill Series

- **Non-Coolant Through -**
솔리드
- **Coolant Through -**
쿨런트 스루

Coolant Through Hurricane Drills

쿨런트 스루 허리케인 드릴



HURRICANE HIGH PERFORMANCE DRILL FEATURES

허리케인 고성능 드릴 기능



- High performance drill with a common shank
- Coolant Through and Non-Coolant Through styles available
- 3XD, 5XD, 8XD
- Uncoated and PowerA coating available
- Now also available in PowerNR coating (call for information)

- 공통 샹크가 있는 고성능 드릴
- 쿨런트 스루 및 비 쿨런트 스루 스타일 사용 가능
- 3XD, 5XD, 8XD
- 비코팅 및 PowerA 코팅 사용 가능
- 이제 PowerNR 코팅에서도 사용 가능(자세한 내용은 전화 문의)

TABLE OF CONTENTS - 목차



Hurricane Drill High Performance Features

허리케인 드릴 고성능 기능 121



Hurricane 3xD Non-Coolant Through & Coolant Through

허리케인 3xD 솔리드 및 쿨런트 스루 122



Hurricane 5xD Non-Coolant Through & Coolant Through

허리케인 5xD 솔리드 및 쿨런트 스루 127



Hurricane 8xD Coolant Through

허리케인 8xD 쿨런트 스루 132



Features • 기능

	2 Flutes 2 플루트		Plain Shank 플레인 샹크
	Non-Coolant Through 솔리드		Coolant Through 쿨런트 스루

Coatings • 코팅

	PowerA PowerA (Aluminum Titanium Nitride AlTiN)
	Uncoated 비코팅

HIGH PERFORMANCE DRILLS

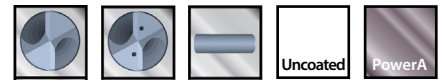

고성능 드릴 - 3XD

3XD	Coated and Uncoated	2 FL, 140° Point and 30° Helix
3XD	코팅 및 비코팅	2 FL, 140° 포인트 및 30° 헬릭스

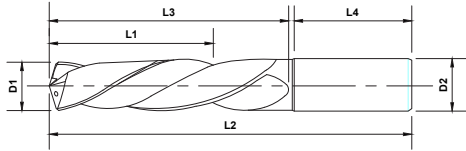

*Hurricane Drills
*허리케인 드릴



Uncoated
Coolant
Through



PowerA
Coolant
Through



OD	LOC	LOF	SHK	SHK-L	OAL	Uncoated		PowerA	
						Non-Coolant Through	Coolant Through	Non-Coolant Through	Coolant Through
D1	L1	L3	D2	L4	L2				
3	14	20	6	36	62	750-002	-	750-002-1	-
3.1	14	20	6	36	62	750-004	-	750-004-1	-
3.17	14	20	6	36	62	750-006	-	750-006-1	-
3.2	14	20	6	36	62	750-010	-	750-010-1	-
3.25	14	20	6	36	62	750-012	-	750-012-1	-
3.3	14	20	6	36	62	750-014	-	750-014-1	-
3.4	14	20	6	36	62	750-016	750-516	750-016-1	750-516-1
3.5	14	20	6	36	62	750-018	750-518	750-018-1	750-518-1

* For extreme performance drilling, try our PowerNR coating. Use the uncoated part number and add -8.

* 최고의 드릴 성능을 위해 PowerNR 코팅을 사용해 보십시오. 코팅되지 않은 부품 번호와 추가 -8을 사용하십시오.

HIGH PERFORMANCE DRILLS

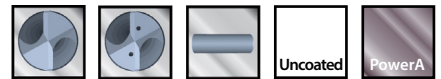

고성능 드릴 - 3XD



OD	LOC	LOF	SHK	SHK-L	OAL	Uncoated		PowerA	
						Non-Coolant Through	Coolant Through	Non-Coolant Through	Coolant Through
D1	L1	L3	D2	L4	L2				
3.57	14	20	6	36	62	750-020	750-520	750-020-1	750-520-1
3.6	14	20	6	36	62	750-024	750-524	750-024-1	750-524-1
3.7	14	20	6	36	62	750-026	750-526	750-026-1	750-526-1
3.8	17	24	6	36	66	750-028	750-528	750-028-1	750-528-1
3.9	17	24	6	36	66	750-030	750-530	750-030-1	750-530-1
3.97	17	24	6	36	66	750-034	750-534	750-034-1	750-534-1
4	17	24	6	36	66	750-036	750-536	750-036-1	750-536-1
4.1	17	24	6	36	66	750-038	750-538	750-038-1	750-538-1
4.2	17	24	6	36	66	750-040	750-540	750-040-1	750-540-1
4.3	17	24	6	36	66	750-042	750-542	750-042-1	750-542-1
4.37	17	24	6	36	66	750-046	750-546	750-046-1	750-546-1
4.4	17	24	6	36	66	750-048	750-548	750-048-1	750-548-1
4.5	17	24	6	36	66	750-050	750-550	750-050-1	750-550-1
4.6	17	24	6	36	66	750-052	750-552	750-052-1	750-552-1
4.65	17	24	6	36	66	750-054	750-554	750-054-1	750-554-1
4.7	17	24	6	36	66	750-056	750-556	750-056-1	750-556-1
4.76	20	28	6	36	66	750-058	750-558	750-058-1	750-558-1
4.8	20	28	6	36	66	750-062	750-562	750-062-1	750-562-1
4.9	20	28	6	36	66	750-064	750-564	750-064-1	750-564-1
5	20	28	6	36	66	750-066	750-566	750-066-1	750-566-1
5.1	20	28	6	36	66	750-068	750-568	750-068-1	750-568-1
5.16	20	28	6	36	66	750-072	750-572	750-072-1	750-572-1
5.2	20	28	6	36	66	750-074	750-574	750-074-1	750-574-1
5.3	20	28	6	36	66	750-076	750-576	750-076-1	750-576-1
5.4	20	28	6	36	66	750-078	750-578	750-078-1	750-578-1
5.5	20	28	6	36	66	750-080	750-580	750-080-1	750-580-1
5.55	20	28	6	36	66	750-082	750-582	750-082-1	750-582-1
5.56	20	28	6	36	66	750-086	750-586	750-086-1	750-586-1
5.6	20	28	6	36	66	750-088	750-588	750-088-1	750-588-1
5.7	20	28	6	36	66	750-090	750-590	750-090-1	750-590-1
5.8	20	28	6	36	66	750-092	750-592	750-092-1	750-592-1
5.9	20	28	6	36	66	750-094	750-594	750-094-1	750-594-1
5.95	20	28	6	36	66	750-096	750-596	750-096-1	750-596-1

HIGH PERFORMANCE DRILLS



HIGH PERFORMANCE DRILLS

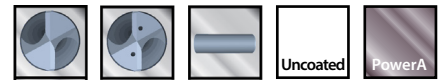

고성능 드릴 - 3XD



OD	LOC	LOF	SHK	SHK-L	OAL	Uncoated		PowerA	
						Non-Coolant Through	Coolant Through	Non-Coolant Through	Coolant Through
6	20	28	6	36	66	750-100	750-600	750-100-1	750-600-1
6.1	24	34	8	36	79	750-102	750-602	750-102-1	750-602-1
6.2	24	34	8	36	79	750-104	750-604	750-104-1	750-604-1
6.3	24	34	8	36	79	750-106	750-606	750-106-1	750-606-1
6.35	24	34	8	36	79	750-108	750-608	750-108-1	750-608-1
6.4	24	34	8	36	79	750-110	750-610	750-110-1	750-610-1
6.5	24	34	8	36	79	750-112	750-612	750-112-1	750-612-1
6.6	24	34	8	36	79	750-114	750-614	750-114-1	750-614-1
6.7	24	34	8	36	79	750-116	750-616	750-116-1	750-616-1
6.75	24	34	8	36	79	750-120	750-620	750-120-1	750-620-1
6.8	24	34	8	36	79	750-122	750-622	750-122-1	750-622-1
6.9	24	34	8	36	79	750-124	750-624	750-124-1	750-624-1
7	24	34	8	36	79	750-126	750-626	750-126-1	750-626-1
7.1	29	41	8	36	79	750-128	750-628	750-128-1	750-628-1
7.14	29	41	8	36	79	750-130	750-630	750-130-1	750-630-1
7.2	29	41	8	36	79	750-134	750-634	750-134-1	750-634-1
7.3	29	41	8	36	79	750-136	750-636	750-136-1	750-636-1
7.4	29	41	8	36	79	750-138	750-638	750-138-1	750-638-1
7.5	29	41	8	36	79	750-140	750-640	750-140-1	750-640-1
7.54	29	41	8	36	79	750-142	750-642	750-142-1	750-642-1
7.6	29	41	8	36	79	750-146	750-646	750-146-1	750-646-1
7.7	29	41	8	36	79	750-148	750-648	750-148-1	750-648-1
7.8	29	41	8	36	79	750-150	750-650	750-150-1	750-650-1
7.9	29	41	8	36	79	750-152	750-652	750-152-1	750-652-1
7.94	29	41	8	36	79	750-156	750-656	750-156-1	750-656-1
8	29	41	8	36	79	750-158	750-658	750-158-1	750-658-1
8.1	35	47	10	40	89	750-160	750-660	750-160-1	750-660-1
8.2	35	47	10	40	89	750-162	750-662	750-162-1	750-662-1
8.3	35	47	10	40	89	750-164	750-664	750-164-1	750-664-1
8.33	35	47	10	40	89	750-166	750-666	750-166-1	750-666-1
8.4	35	47	10	40	89	750-170	750-670	750-170-1	750-670-1
8.5	35	47	10	40	89	750-172	750-672	750-172-1	750-672-1
8.6	35	47	10	40	89	750-174	750-674	750-174-1	750-674-1

HIGH PERFORMANCE DRILLS

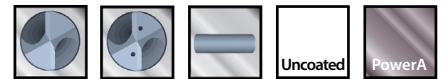

고성능 드릴 - 3XD



OD	LOC	LOF	SHK	SHK-L	OAL	Uncoated		PowerA	
						Non-Coolant Through	Coolant Through	Non-Coolant Through	Coolant Through
D1	L1	L3	D2	L4	L2				
8.7	35	47	10	40	89	750-176	750-676	750-176-1	750-676-1
8.73	35	47	10	40	89	750-178	750-678	750-178-1	750-678-1
8.8	35	47	10	40	89	750-182	750-682	750-182-1	750-682-1
8.9	35	47	10	40	89	750-184	750-684	750-184-1	750-684-1
9	35	47	10	40	89	750-186	750-686	750-186-1	750-686-1
9.1	35	47	10	40	89	750-188	750-688	750-188-1	750-688-1
9.13	35	47	10	40	89	750-192	750-692	750-192-1	750-692-1
9.2	35	47	10	40	89	750-194	750-694	750-194-1	750-694-1
9.25	35	47	10	40	89	750-196	750-696	750-196-1	750-696-1
9.3	35	47	10	40	89	750-198	750-698	750-198-1	750-698-1
9.4	35	47	10	40	89	750-200	750-700	750-200-1	750-700-1
9.5	35	47	10	40	89	750-202	750-702	750-202-1	750-702-1
9.52	35	47	10	40	89	750-204	750-704	750-204-1	750-704-1
9.6	35	47	10	40	89	750-208	750-708	750-208-1	750-708-1
9.7	35	47	10	40	89	750-210	750-710	750-210-1	750-710-1
9.8	35	47	10	40	89	750-212	750-712	750-212-1	750-712-1
9.9	35	47	10	40	89	750-214	750-714	750-214-1	750-714-1
9.92	35	47	10	40	89	750-216	750-716	750-216-1	750-716-1
10	35	47	10	40	89	750-220	750-720	750-220-1	750-720-1
10.1	40	55	12	45	102	750-222	750-722	750-222-1	750-722-1
10.2	40	55	12	45	102	750-224	750-724	750-224-1	750-724-1
10.3	40	55	12	45	102	750-226	750-726	750-226-1	750-726-1
10.32	40	55	12	45	102	750-230	750-730	750-230-1	750-730-1
10.4	40	55	12	45	102	750-232	750-732	750-232-1	750-732-1
10.5	40	55	12	45	102	750-234	750-734	750-234-1	750-734-1
10.6	40	55	12	45	102	750-236	750-736	750-236-1	750-736-1
10.7	40	55	12	45	102	750-238	750-738	750-238-1	750-738-1
10.8	40	55	12	45	102	750-242	750-742	750-242-1	750-742-1
10.9	40	55	12	45	102	750-244	750-744	750-244-1	750-744-1
11	40	55	12	45	102	750-246	750-746	750-246-1	750-746-1
11.1	40	55	12	45	102	750-248	750-748	750-248-1	750-748-1
11.11	40	55	12	45	102	750-250	750-750	750-250-1	750-750-1

HIGH PERFORMANCE DRILLS



HIGH PERFORMANCE DRILLS

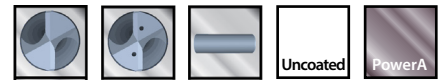

고성능 드릴 - 3XD



OD	LOC	LOF	SHK	SHK-L	OAL	Uncoated		PowerA	
						Non-Coolant Through	Coolant Through	Non-Coolant Through	Coolant Through
11.2	40	55	12	45	102	750-254	750-754	750-254-1	750-754-1
11.3	40	55	12	45	102	750-256	750-756	750-256-1	750-756-1
11.4	40	55	12	45	102	750-258	750-758	750-258-1	750-758-1
11.5	40	55	12	45	102	750-260	750-760	750-260-1	750-760-1
11.6	40	55	12	45	102	750-264	750-764	750-264-1	750-764-1
11.7	40	55	12	45	102	750-266	750-766	750-266-1	750-766-1
11.8	40	55	12	45	102	750-268	750-768	750-268-1	750-768-1
11.9	40	55	12	45	102	750-270	750-770	750-270-1	750-770-1
11.91	40	55	12	45	102	750-274	750-774	750-274-1	750-774-1
12	40	55	12	45	102	750-276	750-776	750-276-1	750-776-1
12.5	43	60	14	45	107	750-280	750-780	750-280-1	750-780-1
12.6	43	60	14	45	107	750-282	750-782	750-282-1	750-782-1
12.7	43	60	14	45	107	750-284	750-784	750-284-1	750-784-1
13	43	60	14	45	107	750-286	750-786	750-286-1	750-786-1
13.5	43	60	14	45	107	750-288	750-788	750-288-1	750-788-1
13.7	43	60	14	45	107	750-290	750-790	750-290-1	750-790-1
14	43	60	14	45	107	750-292	750-792	750-292-1	750-792-1
14.29	45	65	16	48	115	750-294	750-794	750-294-1	750-794-1
14.5	45	65	16	48	115	750-296	750-796	750-296-1	750-796-1
14.7	45	65	16	48	115	750-298	750-798	750-298-1	750-798-1
15	45	65	16	48	115	750-300	750-800	750-300-1	750-800-1
15.5	45	65	16	48	115	750-302	750-802	750-302-1	750-802-1
15.7	45	65	16	48	115	750-304	750-804	750-304-1	750-804-1
16	45	65	16	48	115	750-306	750-806	750-306-1	750-806-1
16.5	51	73	18	48	123	750-308	750-808	750-308-1	750-808-1
17	51	73	18	48	123	750-310	750-810	750-310-1	750-810-1
17.5	51	73	18	48	123	750-312	750-812	750-312-1	750-812-1
18	51	73	18	48	123	750-314	750-814	750-314-1	750-814-1
18.5	55	79	20	50	131	750-316	750-816	750-316-1	750-816-1
19	55	79	20	50	131	750-318	750-818	750-318-1	750-818-1
19.5	55	79	20	50	131	750-320	750-820	750-320-1	750-820-1
20	55	79	20	50	131	750-322	750-822	750-322-1	750-822-1

HIGH PERFORMANCE DRILLS



고성능 드릴 - 5XD

5xD	Coated and Uncoated	2 FL, 140° Point and 30° Helix
5XD	코팅 및 비코팅	2 FL, 140° 포인트 및 30° 헬릭스

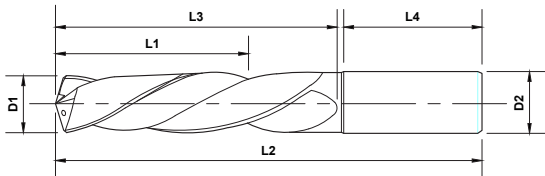

*Hurricane Drills
*허리케인 드릴



HIGH PERFORMANCE DRILLS



Uncoated
Coolant
Through



PowerA
Coolant
Through



OD	LOC	LOF	SHK	SHK-L	OAL	Uncoated		PowerA	
						Non-Coolant Through	Coolant Through	Non-Coolant Through	Coolant Through
D1	L1	L3	D2	L4	L2				
3	23	28	6	36	66	751-002	-	751-002-1	-
3.1	23	28	6	36	66	751-004	-	751-004-1	-
3.17	23	28	6	36	66	751-006	-	751-006-1	-
3.2	23	28	6	36	66	751-010	-	751-010-1	-
3.25	23	28	6	36	66	751-012	-	751-012-1	-
3.3	23	28	6	36	66	751-014	-	751-014-1	-
3.4	23	28	6	36	66	751-016	751-516	751-016-1	751-516-1
3.5	23	28	6	36	66	751-018	751-518	751-018-1	751-518-1
3.57	23	28	6	36	66	751-020	751-520	751-020-1	751-520-1

* For extreme performance drilling, try our PowerNR coating, Use the uncoated part number and add -8.

* 최고의 드릴 성능을 위해 PowerNR 코팅을 사용해 보십시오. 코팅되지 않은 부품 번호와 추가 -8을 사용하십시오.

HIGH PERFORMANCE DRILLS

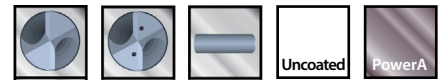

고성능 드릴 - 5XD



OD	LOC	LOF	SHK	SHK-L	OAL	Uncoated		PowerA	
						Non-Coolant Through	Coolant Through	Non-Coolant Through	Coolant Through
3.6	23	28	6	36	66	751-024	751-524	751-024-1	751-524-1
3.7	23	28	6	36	66	751-026	751-526	751-026-1	751-526-1
3.8	29	36	6	36	74	751-028	751-528	751-028-1	751-528-1
3.9	29	36	6	36	74	751-030	751-530	751-030-1	751-530-1
3.97	29	36	6	36	74	751-034	751-534	751-034-1	751-534-1
4	29	36	6	36	74	751-036	751-536	751-036-1	751-536-1
4.1	29	36	6	36	74	751-038	751-538	751-038-1	751-538-1
4.2	29	36	6	36	74	751-040	751-540	751-040-1	751-540-1
4.3	29	36	6	36	74	751-042	751-542	751-042-1	751-542-1
4.37	29	36	6	36	74	751-046	751-546	751-046-1	751-546-1
4.4	29	36	6	36	74	751-048	751-548	751-048-1	751-548-1
4.5	29	36	6	36	74	751-050	751-550	751-050-1	751-550-1
4.6	29	36	6	36	74	751-052	751-552	751-052-1	751-552-1
4.65	29	36	6	36	74	751-054	751-554	751-054-1	751-554-1
4.7	35	44	6	36	82	751-056	751-556	751-056-1	751-556-1
4.76	35	44	6	36	82	751-058	751-558	751-058-1	751-558-1
4.8	35	44	6	36	82	751-062	751-562	751-062-1	751-562-1
4.9	35	44	6	36	82	751-064	751-564	751-064-1	751-564-1
5	35	44	6	36	82	751-066	751-566	751-066-1	751-566-1
5.1	35	44	6	36	82	751-068	751-568	751-068-1	751-568-1
5.16	35	44	6	36	82	751-072	751-572	751-072-1	751-572-1
5.2	35	44	6	36	82	751-074	751-574	751-074-1	751-574-1
5.3	35	44	6	36	82	751-076	751-576	751-076-1	751-576-1
5.4	35	44	6	36	82	751-078	751-578	751-078-1	751-578-1
5.5	35	44	6	36	82	751-080	751-580	751-080-1	751-580-1
5.55	35	44	6	36	82	751-082	751-582	751-082-1	751-582-1
5.56	35	44	6	36	82	751-086	751-586	751-086-1	751-586-1
5.6	35	44	6	36	82	751-088	751-588	751-088-1	751-588-1
5.7	35	44	6	36	82	751-090	751-590	751-090-1	751-590-1
5.8	35	44	6	36	82	751-092	751-592	751-092-1	751-592-1
5.9	35	44	6	36	82	751-094	751-594	751-094-1	751-594-1
5.95	35	44	6	36	82	751-096	751-596	751-096-1	751-596-1
6	35	44	6	36	82	751-100	751-600	751-100-1	751-600-1

HIGH PERFORMANCE DRILLS



고성능 드릴 - 5XD



OD	LOC	LOF	SHK	SHK-L	OAL	Uncoated		PowerA	
						Non-Coolant Through	Coolant Through	Non-Coolant Through	Coolant Through
D1	L1	L3	D2	L4	L2				
6.1	43	53	8	36	91	751-102	751-602	751-102-1	751-602-1
6.2	43	53	8	36	91	751-104	751-604	751-104-1	751-604-1
6.3	43	53	8	36	91	751-106	751-606	751-106-1	751-606-1
6.35	43	53	8	36	91	751-108	751-608	751-108-1	751-608-1
6.4	43	53	8	36	91	751-110	751-610	751-110-1	751-610-1
6.5	43	53	8	36	91	751-112	751-612	751-112-1	751-612-1
6.6	43	53	8	36	91	751-114	751-614	751-114-1	751-614-1
6.7	43	53	8	36	91	751-116	751-616	751-116-1	751-616-1
6.75	43	53	8	36	91	751-120	751-620	751-120-1	751-620-1
6.8	43	53	8	36	91	751-122	751-622	751-122-1	751-622-1
6.9	43	53	8	36	91	751-124	751-624	751-124-1	751-624-1
7	43	53	8	36	91	751-126	751-626	751-126-1	751-626-1
7.1	43	53	8	36	91	751-128	751-628	751-128-1	751-628-1
7.14	43	53	8	36	91	751-130	751-630	751-130-1	751-630-1
7.2	43	53	8	36	91	751-134	751-634	751-134-1	751-634-1
7.3	43	53	8	36	91	751-136	751-636	751-136-1	751-636-1
7.4	43	53	8	36	91	751-138	751-638	751-138-1	751-638-1
7.5	43	53	8	36	91	751-140	751-640	751-140-1	751-640-1
7.54	43	53	8	36	91	751-142	751-642	751-142-1	751-642-1
7.6	43	53	8	36	91	751-146	751-646	751-146-1	751-646-1
7.7	43	53	8	36	91	751-148	751-648	751-148-1	751-648-1
7.8	43	53	8	36	91	751-150	751-650	751-150-1	751-650-1
7.9	43	53	8	36	91	751-152	751-652	751-152-1	751-652-1
7.94	43	53	8	36	91	751-156	751-656	751-156-1	751-656-1
8	43	53	8	36	91	751-158	751-658	751-158-1	751-658-1
8.1	49	61	10	40	103	751-160	751-660	751-160-1	751-660-1
8.2	49	61	10	40	103	751-162	751-662	751-162-1	751-662-1
8.3	49	61	10	40	103	751-164	751-664	751-164-1	751-664-1
8.33	49	61	10	40	103	751-166	751-666	751-166-1	751-666-1
8.4	49	61	10	40	103	751-170	751-670	751-170-1	751-670-1
8.5	49	61	10	40	103	751-172	751-672	751-172-1	751-672-1
8.6	49	61	10	40	103	751-174	751-674	751-174-1	751-674-1
8.7	49	61	10	40	103	751-176	751-676	751-176-1	751-676-1

HIGH PERFORMANCE DRILLS



HIGH PERFORMANCE DRILLS

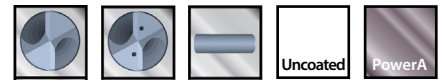

고성능 드릴 - 5XD



OD	LOC	LOF	SHK	SHK-L	OAL	Uncoated		PowerA	
						Non-Coolant Through	Coolant Through	Non-Coolant Through	Coolant Through
D1	L1	L3	D2	L4	L2				
8.73	49	61	10	40	103	751-178	751-678	751-178-1	751-678-1
8.8	49	61	10	40	103	751-182	751-682	751-182-1	751-682-1
8.9	49	61	10	40	103	751-184	751-684	751-184-1	751-684-1
9	49	61	10	40	103	751-186	751-686	751-186-1	751-686-1
9.1	49	61	10	40	103	751-188	751-688	751-188-1	751-688-1
9.13	49	61	10	40	103	751-192	751-692	751-192-1	751-692-1
9.2	49	61	10	40	103	751-194	751-694	751-194-1	751-694-1
9.25	49	61	10	40	103	751-196	751-696	751-196-1	751-696-1
9.3	49	61	10	40	103	751-198	751-698	751-198-1	751-698-1
9.4	49	61	10	40	103	751-200	751-700	751-200-1	751-700-1
9.5	49	61	10	40	103	751-202	751-702	751-202-1	751-702-1
9.52	49	61	10	40	103	751-204	751-704	751-204-1	751-704-1
9.6	49	61	10	40	103	751-208	751-708	751-208-1	751-708-1
9.7	49	61	10	40	103	751-210	751-710	751-210-1	751-710-1
9.8	49	61	10	40	103	751-212	751-712	751-212-1	751-712-1
9.9	49	61	10	40	103	751-214	751-714	751-214-1	751-714-1
9.92	49	61	10	40	103	751-216	751-716	751-216-1	751-716-1
10	49	61	10	40	103	751-220	751-720	751-220-1	751-720-1
10.1	56	71	12	45	118	751-222	751-722	751-222-1	751-722-1
10.2	56	71	12	45	118	751-224	751-724	751-224-1	751-724-1
10.3	56	71	12	45	118	751-226	751-726	751-226-1	751-726-1
10.32	56	71	12	45	118	751-230	751-730	751-230-1	751-730-1
10.4	56	71	12	45	118	751-232	751-732	751-232-1	751-732-1
10.5	56	71	12	45	118	751-234	751-734	751-234-1	751-734-1
10.6	56	71	12	45	118	751-236	751-736	751-236-1	751-736-1
10.7	56	71	12	45	118	751-238	751-738	751-238-1	751-738-1
10.8	56	71	12	45	118	751-242	751-742	751-242-1	751-742-1
10.9	56	71	12	45	118	751-244	751-744	751-244-1	751-744-1
11	56	71	12	45	118	751-246	751-746	751-246-1	751-746-1
11.1	56	71	12	45	118	751-248	751-748	751-248-1	751-748-1
11.11	56	71	12	45	118	751-250	751-750	751-250-1	751-750-1
11.2	56	71	12	45	118	751-254	751-754	751-254-1	751-754-1
11.3	56	71	12	45	118	751-256	751-756	751-256-1	751-756-1

HIGH PERFORMANCE DRILLS

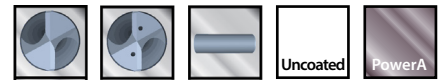

고성능 드릴 - 5XD



OD	LOC	LOF	SHK	SHK-L	OAL	Uncoated		PowerA	
						Non-Coolant Through	Coolant Through	Non-Coolant Through	Coolant Through
D1	L1	L3	D2	L4	L2				
11.4	56	71	12	45	118	751-258	751-758	751-258-1	751-758-1
11.5	56	71	12	45	118	751-260	751-760	751-260-1	751-760-1
11.6	56	71	12	45	118	751-264	751-764	751-264-1	751-764-1
11.7	56	71	12	45	118	751-266	751-766	751-266-1	751-766-1
11.8	56	71	12	45	118	751-268	751-768	751-268-1	751-768-1
11.9	56	71	12	45	118	751-270	751-770	751-270-1	751-770-1
11.91	56	71	12	45	118	751-274	751-774	751-274-1	751-774-1
12	56	71	12	45	118	751-276	751-776	751-276-1	751-776-1
12.5	60	77	14	45	124	751-280	751-780	751-280-1	751-780-1
12.6	60	77	14	45	124	751-282	751-782	751-282-1	751-782-1
12.7	60	77	14	45	124	751-284	751-784	751-284-1	751-784-1
13	60	77	14	45	124	751-286	751-786	751-286-1	751-786-1
13.5	60	77	14	45	124	751-290	751-790	751-290-1	751-790-1
13.7	60	77	14	45	124	751-292	751-792	751-292-1	751-792-1
14	60	77	14	45	124	751-296	751-796	751-296-1	751-796-1
14.29	63	83	16	48	133	751-302	751-802	751-302-1	751-802-1
14.5	63	83	16	48	133	751-304	751-804	751-304-1	751-804-1
14.7	63	83	16	48	133	751-308	751-808	751-308-1	751-808-1
15	63	83	16	48	133	751-310	751-810	751-310-1	751-810-1
15.5	63	83	16	48	133	751-314	751-814	751-314-1	751-814-1
15.7	63	83	16	48	133	751-316	751-816	751-316-1	751-816-1
15.875	63	83	16	48	133	751-318	751-818	751-318-1	751-818-1
16	63	83	16	48	133	751-320	751-820	751-320-1	751-820-1
16.5	71	93	18	48	143	751-322	751-822	751-322-1	751-822-1
17	71	93	18	48	143	751-324	751-824	751-324-1	751-824-1
17.5	71	93	18	48	143	751-326	751-826	751-326-1	751-826-1
18	71	93	18	48	143	751-328	751-828	751-328-1	751-828-1
18.5	77	101	20	50	153	751-330	751-830	751-330-1	751-830-1
19	77	101	20	50	153	751-332	751-832	751-332-1	751-832-1
19.5	77	101	20	50	153	751-334	751-834	751-334-1	751-834-1
20	77	101	20	50	153	751-336	751-836	751-336-1	751-836-1

* For extreme performance drilling, try our PowerNR coating. Use the uncoated part number and add -8.

* 최고의 드릴 성능을 위해 PowerNR 코팅을 사용해 보십시오. 코팅되지 않은 부품 번호와 추가 -8을 사용하십시오.

HIGH PERFORMANCE DRILLS

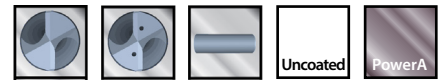

고성능 드릴 - 8XD

8xD	Coated and Uncoated	2 FL, 140° Point and 30° Helix
8xD	코팅 및 비코팅	2 FL, 140° 포인트 및 30° 헬릭스

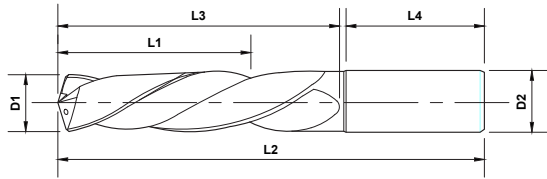

*Hurricane Drills
*허리케인 드릴



Uncoated
Coolant
Through



PowerA
Coolant
Through



OD	LOC	LOF	SHK	SHK-L	OAL	Uncoated		PowerA	
						Non-Coolant Through	Coolant Through	Non-Coolant Through	Coolant Through
D1	L1	L3	D2	L4	L2	-	752-512	-	752-512-1
3.4	29	34	6	34	72	-	752-514	-	752-514-1
3.5	29	34	6	34	72	-	752-518	-	752-518-1
3.6	29	34	6	34	72	-	752-520	-	752-520-1
3.7	29	34	6	34	72	-	752-522	-	752-522-1
3.8	36	43	6	34	81	-	752-524	-	752-524-1
3.9	36	43	6	34	81	-	752-528	-	752-528-1
4	36	43	6	34	81	-		-	

* For extreme performance drilling, try our PowerNR coating, Use the uncoated part number and add -8.

* 최고의 드릴 성능을 위해 PowerNR 코팅을 사용해 보십시오. 코팅되지 않은 부품 번호와 추가 -8을 사용하십시오.

HIGH PERFORMANCE DRILLS

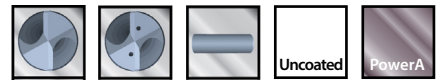

고성능 드릴 - 8XD



HIGH PERFORMANCE DRILLS



OD	LOC	LOF	SHK	SHK-L	OAL	Uncoated		PowerA	
						Non-Coolant Through	Coolant Through	Non-Coolant Through	Coolant Through
D1	L1	L3	D2	L4	L2				
4.1	36	43	6	34	81	-	752-530	-	752-530-1
4.2	36	43	6	34	81	-	752-532	-	752-532-1
4.3	36	43	6	34	81	-	752-534	-	752-534-1
4.4	36	43	6	34	81	-	752-538	-	752-538-1
4.5	36	43	6	34	81	-	752-540	-	752-540-1
4.6	36	43	6	34	81	-	752-542	-	752-542-1
4.7	36	43	6	34	81	-	752-544	-	752-544-1
4.8	53	57	6	34	95	-	752-548	-	752-548-1
4.9	53	57	6	34	95	-	752-550	-	752-550-1
5	53	57	6	36	95	-	752-552	-	752-552-1
5.1	53	57	6	36	95	-	752-554	-	752-554-1
5.2	53	57	6	36	95	-	752-558	-	752-558-1
5.3	53	57	6	36	95	-	752-560	-	752-560-1
5.4	53	57	6	36	95	-	752-562	-	752-562-1
5.5	53	57	6	36	95	-	752-564	-	752-564-1
5.6	53	57	6	36	95	-	752-568	-	752-568-1
5.7	53	57	6	36	95	-	752-570	-	752-570-1
5.8	53	57	6	36	95	-	752-572	-	752-572-1
5.9	53	57	6	36	95	-	752-574	-	752-574-1
6	53	57	6	36	95	-	752-578	-	752-578-1
6.1	66	76	8	36	114	-	752-580	-	752-580-1
6.2	66	76	8	36	114	-	752-582	-	752-582-1
6.3	66	76	8	36	114	-	752-584	-	752-584-1
6.35	66	76	8	36	114	-	752-586	-	752-586-1
6.4	66	76	8	36	114	-	752-588	-	752-588-1
6.5	66	76	8	36	114	-	752-590	-	752-590-1
6.6	66	76	8	36	114	-	752-592	-	752-592-1
6.7	66	76	8	36	114	-	752-594	-	752-594-1
6.8	66	76	8	36	114	-	752-598	-	752-598-1
6.9	66	76	8	36	114	-	752-600	-	752-600-1

HIGH PERFORMANCE DRILLS

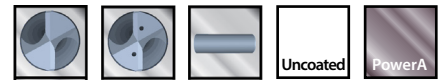

고성능 드릴 - 8XD



OD	LOC	LOF	SHK	SHK-L	OAL	Uncoated		PowerA	
						Non-Coolant Through	Coolant Through	Non-Coolant Through	Coolant Through
7	66	76	8	36	114	-	752-602	-	752-602-1
7.1	66	76	8	36	114	-	752-604	-	752-604-1
7.2	66	76	8	36	114	-	752-608	-	752-608-1
7.3	66	76	8	36	114	-	752-610	-	752-610-1
7.4	66	76	8	36	114	-	752-612	-	752-612-1
7.5	66	76	8	36	114	-	752-614	-	752-614-1
7.6	66	76	8	36	114	-	752-618	-	752-618-1
7.7	66	76	8	36	114	-	752-620	-	752-620-1
7.8	66	76	8	36	114	-	752-622	-	752-622-1
7.9	66	76	8	36	114	-	752-624	-	752-624-1
8	66	76	8	36	114	-	752-628	-	752-628-1
8.1	85	95	10	45	142	-	752-630	-	752-630-1
8.2	85	95	10	45	142	-	752-632	-	752-632-1
8.3	85	95	10	45	142	-	752-634	-	752-634-1
8.4	85	95	10	45	142	-	752-638	-	752-638-1
8.5	85	95	10	45	142	-	752-640	-	752-640-1
8.6	85	95	10	45	142	-	752-642	-	752-642-1
8.7	85	95	10	45	142	-	752-644	-	752-644-1
8.8	85	95	10	45	142	-	752-648	-	752-648-1
8.9	85	95	10	45	142	-	752-650	-	752-650-1
9	85	95	10	45	142	-	752-652	-	752-652-1
9.1	85	95	10	45	142	-	752-654	-	752-654-1
9.2	85	95	10	45	142	-	752-658	-	752-658-1
9.3	85	95	10	45	142	-	752-660	-	752-660-1
9.4	85	95	10	45	142	-	752-662	-	752-662-1
9.5	85	95	10	45	142	-	752-664	-	752-664-1
9.52	85	95	10	45	142	-	752-666	-	752-666-1
9.6	85	95	10	45	142	-	752-670	-	752-670-1
9.7	85	95	10	45	142	-	752-672	-	752-672-1
9.8	85	95	10	45	142	-	752-674	-	752-674-1
9.9	85	95	10	45	142	-	752-676	-	752-676-1
10	85	95	10	45	142	-	752-680	-	752-680-1
10.1	99	114	12	46	162	-	752-682	-	752-682-1
10.2	99	114	12	46	162	-	752-684	-	752-684-1
10.3	99	114	12	46	162	-	752-686	-	752-686-1

HIGH PERFORMANCE DRILLS

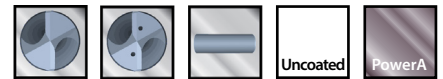

고성능 드릴 - 8XD



OD	LOC	LOF	SHK	SHK-L	OAL	Uncoated		PowerA	
						Non-Coolant Through	Coolant Through	Non-Coolant Through	Coolant Through
10.4	99	114	12	46	162	-	752-690	-	752-690-1
10.5	99	114	12	46	162	-	752-692	-	752-692-1
10.6	99	114	12	46	162	-	752-694	-	752-694-1
10.7	99	114	12	46	162	-	752-696	-	752-696-1
10.8	99	114	12	46	162	-	752-700	-	752-700-1
10.9	99	114	12	46	162	-	752-702	-	752-702-1
11	99	114	12	46	162	-	752-704	-	752-704-1
11.1	99	114	12	46	162	-	752-706	-	752-706-1
11.2	99	114	12	46	162	-	752-710	-	752-710-1
11.3	99	114	12	46	162	-	752-712	-	752-712-1
11.4	99	114	12	46	162	-	752-714	-	752-714-1
11.5	99	114	12	46	162	-	752-716	-	752-716-1
11.6	99	114	12	46	162	-	752-720	-	752-720-1
11.7	99	114	12	46	162	-	752-722	-	752-722-1
11.8	99	114	12	46	162	-	752-724	-	752-724-1
11.9	99	114	12	46	162	-	752-726	-	752-726-1
12	99	114	12	46	162	-	752-730	-	752-730-1
12.5	116	133	14	47	182	-	752-734	-	752-734-1
12.7	116	133	14	47	182	-	752-736	-	752-736-1
13	116	133	14	47	182	-	752-738	-	752-738-1
13.5	116	133	14	47	182	-	752-740	-	752-740-1
14	116	133	14	47	182	-	752-742	-	752-742-1
14.5	132	152	16	50	204	-	752-744	-	752-744-1
15	132	152	16	50	204	-	752-746	-	752-746-1
15.5	132	152	16	50	204	-	752-748	-	752-748-1
16	132	152	16	50	204	-	752-750	-	752-750-1
16.5	150	171	18	50	223	-	752-752	-	752-752-1
17	150	171	18	50	223	-	752-754	-	752-754-1
17.5	150	171	18	50	223	-	752-756	-	752-756-1
18	150	171	18	50	223	-	752-758	-	752-758-1
18.5	166	190	20	52	244	-	752-760	-	752-760-1
19	166	190	20	52	244	-	752-762	-	752-762-1
19.5	166	190	20	52	244	-	752-766	-	752-766-1
20	166	190	20	52	244	-	752-768	-	752-768-1

HIGH PERFORMANCE DRILLS



BURS

버

- **Full Line of Shapes and Cut Types**
플라인 세이프 및 컷
- **Special Purpose and Custom Burs Available**
특수 목적 및 맞춤형 버 사용 가능

Mastercut's patented brazing process gives our burs the extra strength you need to push harder and run faster.

특허받은 Mastercut의 브레이징 공정은 버에 더 세게 밀고 더 빨리 작동하는 데 필요한 추가 강도를 제공합니다.

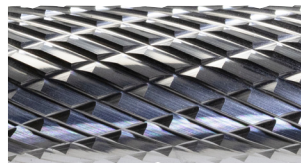

DOUBLECUT (DC)

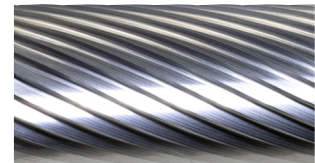

SINGLECUT (SC)

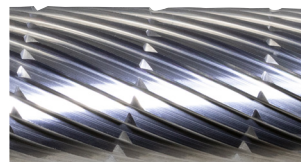

CHIPBREAKER (CB)

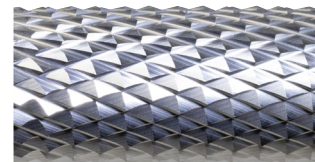

DIAMONDCUT (DM)

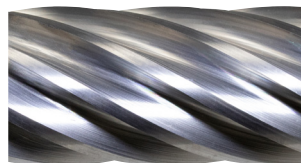

ALUMACUT (FM)
For Aluminum



NX CUT (NX)
For Stainless Steel

LEGENDS - 범례

Non-Ferrous N	Alumacuts recommended for non-ferrous materials
	비철금속 재료에 권장되는 알루마컷

Mastercut's Superior Carbide Blend – A-Gr-SiV (Active Grain Sized Volume)

Our superior tungsten carbide gives you the ability to be **aggressive** when you need to be. Growth inhibitors in our submicron carbide blanks maintain the most consistent grain size available, giving you superior hardness and toughness.

Mastercut의 탁월한 카바이드 혼합 – A-Gr-SiV(액티브 결정 입도 볼륨)

당사의 우수한 텅스텐 카바이드는 귀하가 필요할 때 공격적으로 대응할 수 있는 능력을 제공합니다. 당사의 서브 마이크론 카바이드 블랭크의 성장 억제제는 가장 균일한 결정 입도를 유지하며, 탁월한 경도와 인성을 제공합니다.

TABLE OF CONTENTS - 목차





















	SA Burs - Cylindrical Shape without End Cut SA 버 - 엔드 컷 없는 원통형 139	<table border="0"> <tr> <td style="background-color: #cccccc; padding: 2px;">Hardened H</td> <td style="background-color: #ff0000; color: white; padding: 2px;">Cast Iron K</td> <td style="background-color: #ff9900; padding: 2px;">Titanium S</td> <td style="background-color: #ffff00; padding: 2px;">Stainless M</td> <td style="background-color: #0000ff; color: white; padding: 2px;">Steel P</td> </tr> </table>	Hardened H	Cast Iron K	Titanium S	Stainless M	Steel P
Hardened H	Cast Iron K	Titanium S	Stainless M	Steel P			
	SB Burs - Cylindrical Shape with End Cut SB 버 - 엔드 컷 있는 원통형 140	<table border="0"> <tr> <td style="background-color: #cccccc; padding: 2px;">Hardened H</td> <td style="background-color: #ff0000; color: white; padding: 2px;">Cast Iron K</td> <td style="background-color: #ff9900; padding: 2px;">Titanium S</td> <td style="background-color: #ffff00; padding: 2px;">Stainless M</td> <td style="background-color: #0000ff; color: white; padding: 2px;">Steel P</td> </tr> </table>	Hardened H	Cast Iron K	Titanium S	Stainless M	Steel P
Hardened H	Cast Iron K	Titanium S	Stainless M	Steel P			
	SC Burs - Radius Cylindrical Shape SC 버 - 반경 원통형 141	<table border="0"> <tr> <td style="background-color: #cccccc; padding: 2px;">Hardened H</td> <td style="background-color: #ff0000; color: white; padding: 2px;">Cast Iron K</td> <td style="background-color: #ff9900; padding: 2px;">Titanium S</td> <td style="background-color: #ffff00; padding: 2px;">Stainless M</td> <td style="background-color: #0000ff; color: white; padding: 2px;">Steel P</td> </tr> </table>	Hardened H	Cast Iron K	Titanium S	Stainless M	Steel P
Hardened H	Cast Iron K	Titanium S	Stainless M	Steel P			
	SD Burs - Ball Shape SD 버 - 볼형 142	<table border="0"> <tr> <td style="background-color: #cccccc; padding: 2px;">Hardened H</td> <td style="background-color: #ff0000; color: white; padding: 2px;">Cast Iron K</td> <td style="background-color: #ff9900; padding: 2px;">Titanium S</td> <td style="background-color: #ffff00; padding: 2px;">Stainless M</td> <td style="background-color: #0000ff; color: white; padding: 2px;">Steel P</td> </tr> </table>	Hardened H	Cast Iron K	Titanium S	Stainless M	Steel P
Hardened H	Cast Iron K	Titanium S	Stainless M	Steel P			
	SE Burs - Oval Shape SE 버 - 타원형 143	<table border="0"> <tr> <td style="background-color: #cccccc; padding: 2px;">Hardened H</td> <td style="background-color: #ff0000; color: white; padding: 2px;">Cast Iron K</td> <td style="background-color: #ff9900; padding: 2px;">Titanium S</td> <td style="background-color: #ffff00; padding: 2px;">Stainless M</td> <td style="background-color: #0000ff; color: white; padding: 2px;">Steel P</td> </tr> </table>	Hardened H	Cast Iron K	Titanium S	Stainless M	Steel P
Hardened H	Cast Iron K	Titanium S	Stainless M	Steel P			
	SF Burs - Radius Tree Shape SF 버 - 반경 트리형 144	<table border="0"> <tr> <td style="background-color: #cccccc; padding: 2px;">Hardened H</td> <td style="background-color: #ff0000; color: white; padding: 2px;">Cast Iron K</td> <td style="background-color: #ff9900; padding: 2px;">Titanium S</td> <td style="background-color: #ffff00; padding: 2px;">Stainless M</td> <td style="background-color: #0000ff; color: white; padding: 2px;">Steel P</td> </tr> </table>	Hardened H	Cast Iron K	Titanium S	Stainless M	Steel P
Hardened H	Cast Iron K	Titanium S	Stainless M	Steel P			
	SG Burs - Pointed Tree Shape SG 버 - 뾰족한 트리형 145	<table border="0"> <tr> <td style="background-color: #cccccc; padding: 2px;">Hardened H</td> <td style="background-color: #ff0000; color: white; padding: 2px;">Cast Iron K</td> <td style="background-color: #ff9900; padding: 2px;">Titanium S</td> <td style="background-color: #ffff00; padding: 2px;">Stainless M</td> <td style="background-color: #0000ff; color: white; padding: 2px;">Steel P</td> </tr> </table>	Hardened H	Cast Iron K	Titanium S	Stainless M	Steel P
Hardened H	Cast Iron K	Titanium S	Stainless M	Steel P			
	SH Burs - Flame Shape SH 버 - 불꽃형 146	<table border="0"> <tr> <td style="background-color: #cccccc; padding: 2px;">Hardened H</td> <td style="background-color: #ff0000; color: white; padding: 2px;">Cast Iron K</td> <td style="background-color: #ff9900; padding: 2px;">Titanium S</td> <td style="background-color: #ffff00; padding: 2px;">Stainless M</td> <td style="background-color: #0000ff; color: white; padding: 2px;">Steel P</td> </tr> </table>	Hardened H	Cast Iron K	Titanium S	Stainless M	Steel P
Hardened H	Cast Iron K	Titanium S	Stainless M	Steel P			
	SJ Burs - 60° Included Cone Shape SJ 버 - 60° 포함 원뿔형 147	<table border="0"> <tr> <td style="background-color: #cccccc; padding: 2px;">Hardened H</td> <td style="background-color: #ff0000; color: white; padding: 2px;">Cast Iron K</td> <td style="background-color: #ff9900; padding: 2px;">Titanium S</td> <td style="background-color: #ffff00; padding: 2px;">Stainless M</td> <td style="background-color: #0000ff; color: white; padding: 2px;">Steel P</td> </tr> </table>	Hardened H	Cast Iron K	Titanium S	Stainless M	Steel P
Hardened H	Cast Iron K	Titanium S	Stainless M	Steel P			
	SK Burs - 90° Included Cone Shape SK 버 - 90° 포함 원뿔형 147	<table border="0"> <tr> <td style="background-color: #cccccc; padding: 2px;">Hardened H</td> <td style="background-color: #ff0000; color: white; padding: 2px;">Cast Iron K</td> <td style="background-color: #ff9900; padding: 2px;">Titanium S</td> <td style="background-color: #ffff00; padding: 2px;">Stainless M</td> <td style="background-color: #0000ff; color: white; padding: 2px;">Steel P</td> </tr> </table>	Hardened H	Cast Iron K	Titanium S	Stainless M	Steel P
Hardened H	Cast Iron K	Titanium S	Stainless M	Steel P			
	SL Burs - Radius Cone Shape SL 버 - 반경 원뿔형 148	<table border="0"> <tr> <td style="background-color: #cccccc; padding: 2px;">Hardened H</td> <td style="background-color: #ff0000; color: white; padding: 2px;">Cast Iron K</td> <td style="background-color: #ff9900; padding: 2px;">Titanium S</td> <td style="background-color: #ffff00; padding: 2px;">Stainless M</td> <td style="background-color: #0000ff; color: white; padding: 2px;">Steel P</td> </tr> </table>	Hardened H	Cast Iron K	Titanium S	Stainless M	Steel P
Hardened H	Cast Iron K	Titanium S	Stainless M	Steel P			
	SM Burs - Pointed Cone Shape SM 버 - 뾰족한 원뿔형 149	<table border="0"> <tr> <td style="background-color: #cccccc; padding: 2px;">Hardened H</td> <td style="background-color: #ff0000; color: white; padding: 2px;">Cast Iron K</td> <td style="background-color: #ff9900; padding: 2px;">Titanium S</td> <td style="background-color: #ffff00; padding: 2px;">Stainless M</td> <td style="background-color: #0000ff; color: white; padding: 2px;">Steel P</td> </tr> </table>	Hardened H	Cast Iron K	Titanium S	Stainless M	Steel P
Hardened H	Cast Iron K	Titanium S	Stainless M	Steel P			
	SN Burs - Inverted Cone Shape SN 버 - 역원뿔형 150	<table border="0"> <tr> <td style="background-color: #cccccc; padding: 2px;">Hardened H</td> <td style="background-color: #ff0000; color: white; padding: 2px;">Cast Iron K</td> <td style="background-color: #ff9900; padding: 2px;">Titanium S</td> <td style="background-color: #ffff00; padding: 2px;">Stainless M</td> <td style="background-color: #0000ff; color: white; padding: 2px;">Steel P</td> </tr> </table>	Hardened H	Cast Iron K	Titanium S	Stainless M	Steel P
Hardened H	Cast Iron K	Titanium S	Stainless M	Steel P			

TABLE OF CONTENTS - 목차

	Fiberglass Routers 유리섬유 라우터151	N/A					
	Diemills Diemills152	<table border="0"> <tr> <td>H</td> <td>K</td> <td>S</td> <td>M</td> <td>P</td> </tr> </table>	H	K	S	M	P
H	K	S	M	P			
	Piloted Diemills Piloted Diemills153	<table border="0"> <tr> <td>H</td> <td>K</td> <td>S</td> <td>M</td> <td>P</td> </tr> </table>	H	K	S	M	P
H	K	S	M	P			
	Tire Burs 타이어 버154	N/A					
	Plastic Pouch Bur Sets 플라스틱 파우치 버 세트154	<table border="0"> <tr> <td>H</td> <td>K</td> <td>S</td> <td>M</td> <td>P</td> </tr> </table>	H	K	S	M	P
H	K	S	M	P			
	12 Piece Plastic Box Bur Sets 12조 플라스틱 박스 버 세트155	<table border="0"> <tr> <td>H</td> <td>K</td> <td>S</td> <td>M</td> <td>P</td> </tr> </table>	H	K	S	M	P
H	K	S	M	P			
	24 Piece Countertop Displays 24조 카운터톱 디스플레이155	<table border="0"> <tr> <td>H</td> <td>K</td> <td>S</td> <td>M</td> <td>P</td> </tr> </table>	H	K	S	M	P
H	K	S	M	P			

General Bur Speed Recommendations

The following chart is a general and approximate recommendation. Variations to achieve desired results may be necessary. Long shank burs should be used at reduced speeds.

Bur Diameter	RPM
1/8" or 3mm Solid Carbide	45,000-50,000
3/16" or 5mm Solid Carbide	35,000-40,000
3/16" or 5mm Carbide Head Brazed to 1/8" or 3mm Steel Shank	30,000-35,000
1/4" or 6mm Solid Carbide	30,000-35,000
1/4" or 6mm Carbide Head Brazed to 1/8" or 3mm Steel Shank	25,000-30,000
5/16" or 8mm Carbide Head Brazed to 1/4" or 6mm Steel Shank	25,000-30,000
3/8" or 10mm Carbide Head Brazed to 1/4" or 6mm Steel Shank	25,000-30,000
7/16" or 11mm Carbide Head Brazed to 1/4" or 6mm Steel Shank	20,000-25,000
1/2" or 12mm Carbide Head Brazed to 1/4" or 6mm Steel Shank	20,000-25,000
5/8" or 16mm Carbide Head Brazed to 1/4" or 6mm Steel Shank	15,000-20,000
3/4" or 18mm Carbide Head Brazed to 1/4" or 6mm Steel Shank	15,000-20,000
1" or 25mm Carbide Head on 1/4" or 6mm Steel Shank	12,000-18,000

SA BURS - CYLINDRICAL SHAPE WITHOUT ENDCUT

SA 버 - 엔드 컷 없는 원통형

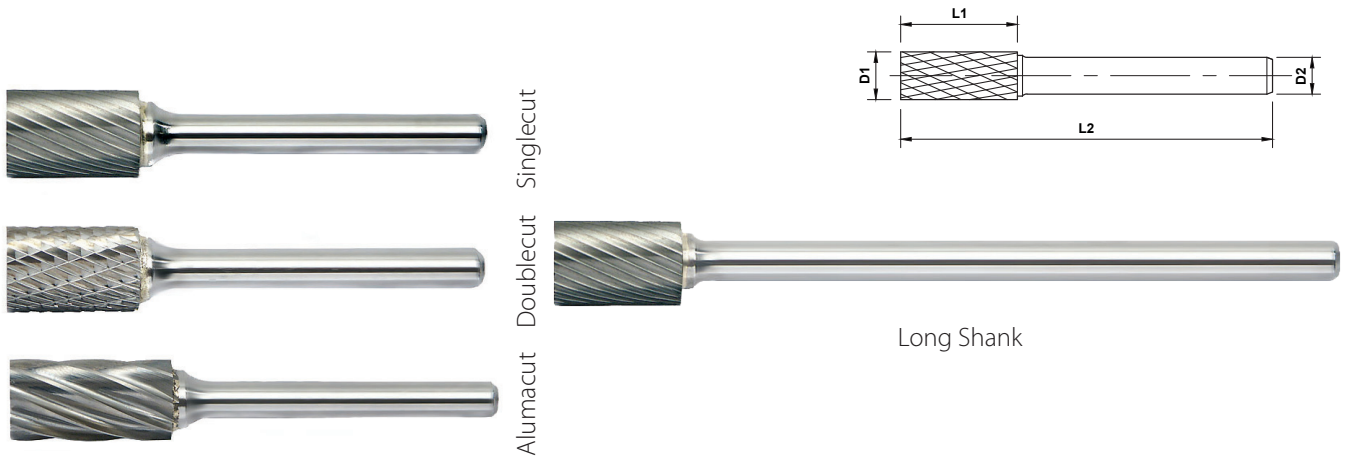

Length Key (K)

Standard Long * Solid Carbide

Quick Ship Items

Non-Ferrous **N** Alumacuts recommended for non-ferrous materials

Cast Iron **K** Titanium **S** Stainless **M** Steel **P** Hardened **H**

K	OD	LOC	SHK	OAL	Cut Type									
					D1	L1	D2	L2	Singlecut	Doublecut	Alumacut	Diamondcut	Chipbreaker	NX Cut
*	1.5	6	3	38					SA-41MMSC	SA-41MMDC	SA-41MMFM	SA-41MMDM	SA-41MMCB	-
*	2.5	11	3	38					SA-42MMSC	SA-42MMDC	SA-42MMFM	SA-42MMDM	SA-42MMCB	-
*	3	12.7	6	50					SA-12MMSC	SA-12MMDC	SA-12MMFM	SA-12MMDM	SA-12MMCB	-
*		14	3	38					SA-43MMSC	SA-43MMDC	SA-43MMFM	SA-43MMDM	SA-43MMCB	-
*	5	16	6	50					SA-14MMSC	SA-14MMDC	SA-14MMFM	SA-14MMDM	SA-14MMCB	-
*	6	25	6	50					SA-1MMASC	SA-1MMADC	SA-1MMAFM	SA-1MMADM	SA-1MMACB	-
*		16	6	50					SA-1MMSC	SA-1MMDC	SA-1MMFM	SA-1MMDM	SA-1MMCB	-
	6	16	6	162					SA-1MML6SC	SA-1MML6DC	SA-1MML6FM	SA-1MML6DM	SA-1MML6CB	-
		6.3	12.7	3	50					SA-51MMSC	SA-51MMDC	SA-51MMFM	SA-51MMDM	SA-51MMCB
	8	25	6	70					SA-2MMASC	SA-2MMADC	SA-2MMAFM	SA-2MMADM	SA-2MMACB	-
		19	6	64					SA-2MMSC	SA-2MMDC	SA-2MMFM	SA-2MMDM	SA-2MMCB	-
	9.5	25	6	70					SA-3MMASC	SA-3MMADC	SA-3MMAFM	SA-3MMADM	SA-3MMACB	-
		38	6	83					SA-3MMBSC	SA-3MMBDC	SA-3MMBFM	SA-3MMBDM	SA-3MMBCB	-
		19	6	64					SA-3MMSC	SA-3MMDC	SA-3MMFM	SA-3MMDM	SA-3MMCB	SA-3MMNX
		19	6	169					SA-3MML6SC	SA-3MML6DC	SA-3MML6FM	SA-3MML6DM	SA-3MML6CB	-
	11	25	6	70					SA-4MMSC	SA-4MMDC	SA-4MMFM	SA-4MMDM	SA-4MMCB	-
		25	6	70					SA-5MMSC	SA-5MMDC	SA-5MMFM	SA-5MMDM	SA-5MMCB	SA-5MMNX
	12.7	25	6	178					SA-5MML6SC	SA-5MML6DC	SA-5MML6FM	SA-5MML6DM	SA-5MML6CB	-
		16	25	6	70				SA-6MMSC	SA-6MMDC	SA-6MMFM	SA-6MMDM	SA-6MMCB	-
	19	25	6	70				SA-7MMSC	SA-7MMDC	SA-7MMFM	SA-7MMDM	SA-7MMCB	-	
	25.4	25	6	70				SA-9MMSC	SA-9MMDC	SA-9MMFM	SA-9MMDM	SA-9MMCB	-	

* Solid Carbide • *솔리드 카바이드

SB BURS - CYLINDRICAL SHAPE WITH ENDCUT

SB 버 - 엔드 컷 있는 원통형



Singlecut
Doublecut
Alumacut

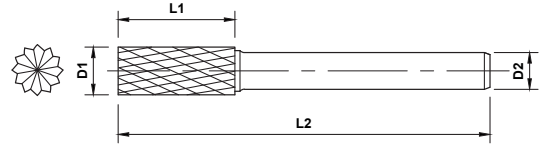

Long Shank

Length Key (K)

Standard Long * Solid Carbide

Quick Ship Items

Non-Ferrous **N** Alumacuts recommended for non-ferrous materials

Cast Iron **K** Titanium **S** Stainless **M** Steel **P** Hardened **H**

	OD	LOC	SHK	OAL	Cut Type				
	D1	L1	D2	L2	Singlecut	Doublecut	Alumacut	Diamondcut	Chipbreaker
*	1.5	6	3	38	SB-41MMSC	SB-41MMDC	SB-41MMFM	SB-41MMDM	SB-41MMCB
*	2.5	11	3	38	SB-42MMSC	SB-42MMDC	SB-42MMFM	SB-42MMDM	SB-42MMCB
*	3	12.7	6	50	SB-11MMSC	SB-11MMDC	SB-11MMFM	SB-11MMDM	SB-11MMCB
*		12.7	6	50	SB-12MMSC	SB-12MMDC	SB-12MMFM	SB-12MMDM	SB-12MMCB
*	5	14	3	38	SB-43MMSC	SB-43MMDC	SB-43MMFM	SB-43MMDM	SB-43MMCB
*		16	6	50	SB-14MMSC	SB-14MMDC	SB-14MMFM	SB-14MMDM	SB-14MMCB
*	6	25	6	50	SB-1MMASC	SB-1MMADC	SB-1MMAFM	SB-1MMADM	SB-1MMACB
*		16	6	50	SB-1MMSC	SB-1MMDC	SB-1MMFM	SB-1MMDM	SB-1MMCB
	6.3	16	6	162	SB-1MML6SC	SB-1MML6DC	SB-1MML6FM	SB-1MML6DM	SB-1MML6CB
		4.7	3	43	SB-51MMSC	SB-51MMDC	SB-51MMFM	SB-51MMDM	SB-51MMCB
	8	25	6	70	SB-2MMASC	SB-2MMADC	SB-2MMAFM	SB-2MMADM	SB-2MMACB
		19	6	64	SB-2MMSC	SB-2MMDC	SB-2MMFM	SB-2MMDM	SB-2MMCB
	9.5	38	6	83	SB-3BMMSC	SB-3BMMDC	SB-3BMMFM	SB-3BMMDM	SB-3BMMCB
		25	6	70	SB-3MMASC	SB-3MMADC	SB-3MMAFM	SB-3MMADM	SB-3MMACB
		19	6	64	SB-3MMSC	SB-3MMDC	SB-3MMFM	SB-3MMDM	SB-3MMCB
		19	6	169	SB-3MML6SC	SB-3MML6DC	SB-3MML6FM	SB-3MML6DM	SB-3MML6CB
	11	25	6	70	SB-4MMSC	SB-4MMDC	SB-4MMFM	SB-4MMDM	SB-4MMCB
	12.7	25	6	70	SB-5MMSC	SB-5MMDC	SB-5MMFM	SB-5MMDM	SB-5MMCB
		25	6	175	SB-5MML6SC	SB-5MML6DC	SB-5MML6FM	SB-5MML6DM	SB-5MML6CB
	16	25	6	70	SB-6MMSC	SB-6MMDC	SB-6MMFM	SB-6MMDM	SB-6MMCB
	19	25	6	70	SB-7MMSC	SB-7MMDC	SB-7MMFM	SB-7MMDM	SB-7MMCB
	25.4	25	6	70	SB-9MMSC	SB-9MMDC	SB-9MMFM	SB-9MMDM	SB-9MMCB

* Solid Carbide • 슬리드 카바이드

SC BURS - RADIUS CYLINDRICAL SHAPE

SC 버 - 반경 원통형

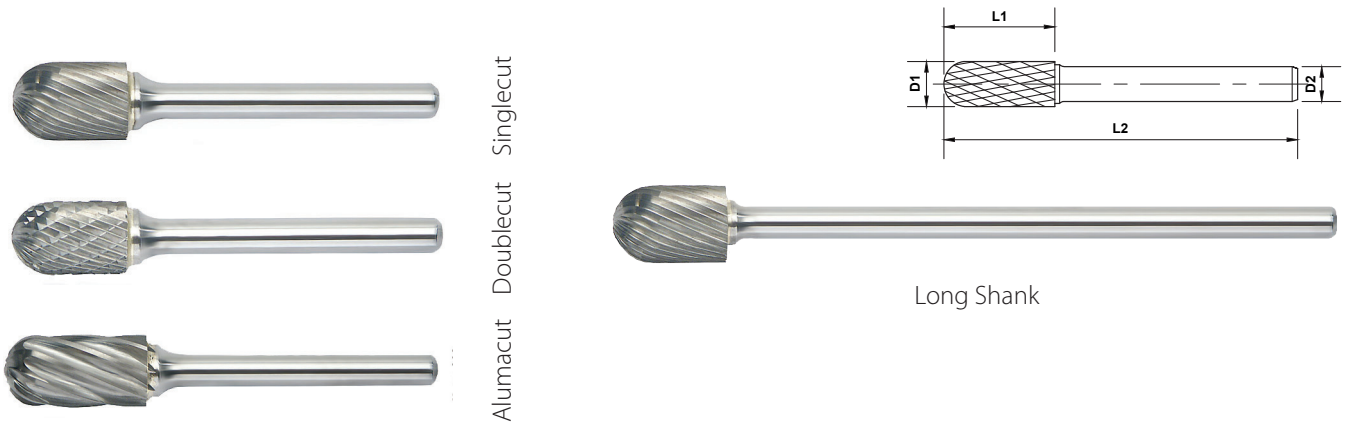

Length Key (K)

Standard Long * Solid Carbide

Quick Ship Items

Non-Ferrous **N** Alumacuts recommended for non-ferrous materials

Cast Iron **K** Titanium **S** Stainless **M** Steel **P** Hardened **H**

	OD	LOC	SHK	OAL	Cut Type					
					D1	L1	D2	L2	Singlecut	Doublecut
*	2.5	11	3	38	SC-41MMSC	SC-41MMDC	SC-41MMFM	SC-41MMDM	SC-41MMCB	-
*		16	6	50	SC-11MMSC	SC-11MMDC	SC-11MMFM	SC-11MMDM	SC-11MMCB	-
*		16	6	50	SC-12MMSC	SC-12MMDC	SC-12MMFM	SC-12MMDM	SC-12MMCB	-
*	3	14	3	38	SC-42MMSC	SC-42MMDC	SC-42MMFM	SC-42MMDM	SC-42MMCB	-
*		14	3	50	SC-42MML2SC	SC-42MML2DC	SC-42MML2FM	SC-42MML2DM	SC-42MML2CB	-
*		14	3	75	SC-42MML3SC	SC-42MML3DC	SC-42MML3FM	SC-42MML3DM	SC-42MML3CB	-
*	4	16	6	50	SC-13MMSC	SC-13MMDC	-	SC-13MMDM	-	-
*	5	16	6	50	SC-14MMSC	SC-14MMDC	SC-14MMFM	SC-14MMDM	SC-14MMCB	-
*	6	25	6	50	SC-1MMASC	SC-1MMADC	SC-1MMAFM	SC-1MMADM	SC-1MMACB	-
*		16	6	50	SC-1MMSC	SC-1MMDC	SC-1MMFM	SC-1MMDM	SC-1MMCB	-
*		16	6	162	SC-1MML6SC	SC-1MML6DC	SC-1MML6FM	SC-1MML6DM	SC-1MML6CB	-
	6.3	12.7	3	50	SC-51MMSC	SC-51MMDC	SC-51MMFM	SC-51MMDM	SC-51MMCB	-
	8	25	6	70	SC-2MMASC	SC-2MMADC	SC-2MMAFM	SC-2MMADM	SC-2MMACB	-
		19	6	64	SC-2MMSC	SC-2MMDC	SC-2MMFM	SC-2MMDM	SC-2MMCB	-
	9.5	25	6	70	SC-3MMASC	SC-3MMADC	SC-3MMAFM	SC-3MMADM	SC-3MMACB	-
		19	6	64	SC-3MMSC	SC-3MMDC	SC-3MMFM	SC-3MMDM	SC-3MMCB	SC-3MMNX
	19	6	169	SC-3MML6SC	SC-3MML6DC	SC-3MML6FM	SC-3MML6DM	SC-3MML6CB	-	
	11	25	6	70	SC-4MMSC	SC-4MMDC	SC-4MMFM	SC-4MMDM	SC-4MMCB	-
	12.7	25	6	70	SC-5MMSC	SC-5MMDC	SC-5MMFM	SC-5MMDM	SC-5MMCB	SC-5MMNX
25		6	175	SC-5MML6SC	SC-5MML6DC	SC-5MML6FM	SC-5MML6DM	SC-5MML6CB	-	
	16	25	6	70	SC-6MMSC	SC-6MMDC	SC-6MMFM	SC-6MMDM	SC-6MMCB	-
	19	25	6	70	SC-7MMSC	SC-7MMDC	SC-7MMFM	SC-7MMDM	SC-7MMCB	-
	25.4	25	6	70	SC-9MMSC	SC-9MMDC	SC-9MMFM	SC-9MMDM	SC-9MMCB	-

* Solid Carbide • *솔리드 카바이드

SD BURS - BALL SHAPE

SD 버 - 볼형

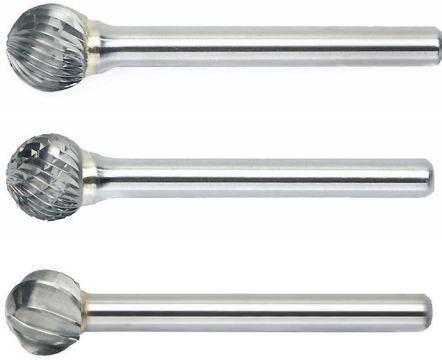

Singlecut
Doublecut
Alumacut

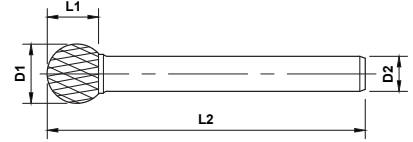

Long Shank

Length Key (K)

Standard Long * Solid Carbide

Quick Ship Items

Non-Ferrous **N** Alumacuts recommended for non-ferrous materials

Cast Iron **K** Titanium **S** Stainless **M** Steel **P** Hardened **H**

	Length Key (K)				Cut Type					
	OD	LOC	SHK	OAL	Singlecut	Doublecut	Alumacut	Diamondcut	Chipbreaker	NX Cut
*	2.5	2.3	3	38	SD-41MMSC	SD-41MMDC	SD-41MMFM	SD-41MMDM	SD-41MMCB	-
*	3	2	6	50	SD-12MMSC	SD-12MMDC	SD-12MMFM	SD-12MMDM	SD-12MMCB	-
*		2.5	3	38	SD-42MMSC	SD-42MMDC	SD-42MMFM	SD-42MMDM	SD-42MMCB	-
*		2.5	3	50	SD-42MML2SC	SD-42MML2DC	SD-42MML2FM	SD-42MML2DM	SD-42MML2CB	-
*		2.5	3	75	SD-42MML3SC	SD-42MML3DC	SD-42MML3FM	SD-42MML3DM	SD-42MML3CB	-
*	5	4	6	50	SD-14MMSC	SD-14MMDC	SD-14MMFM	SD-14MMDM	SD-14MMCB	-
*	6	5	6	50	SD-1MMSC	SD-1MMDC	SD-1MMFM	SD-1MMDM	SD-1MMCB	-
		5	6	155	SD-1MML6SC	SD-1MML6DC	SD-1MML6FM	SD-1MML6DM	SD-1MML6CB	-
	6.3	5	3	44	SD-51MMSC	SD-51MMDC	SD-51MMFM	SD-51MMDM	SD-51MMCB	-
	8	6.4	6	51.4	SD-2MMSC	SD-2MMDC	SD-2MMFM	SD-2MMDM	SD-2MMCB	-
	9.5	8	6	53	SD-3MMSC	SD-3MMDC	SD-3MMFM	SD-3MMDM	SD-3MMCB	SD-3MMNX
		8	6	158	SD-3MML6SC	SD-3MML6DC	SD-3MML6FM	SD-3MML6DM	SD-3MML6CB	-
	11	9.5	6	54.5	SD-4MMSC	SD-4MMDC	SD-4MMFM	SD-4MMDM	SD-4MMCB	-
		11	6	56	SD-5MMSC	SD-5MMDC	SD-5MMFM	SD-5MMDM	SD-5MMCB	SD-5MMNX
	12.7	11	6	161	SD-5MML6SC	SD-5MML6DC	SD-5MML6FM	SD-5MML6DM	SD-5MML6CB	-
		14	6	59	SD-6MMSC	SD-6MMDC	SD-6MMFM	SD-6MMDM	SD-6MMCB	-
	19	17	6	62	SD-7MMSC	SD-7MMDC	SD-7MMFM	SD-7MMDM	SD-7MMCB	-
	25.4	23	6	68	SD-9MMSC	SD-9MMDC	SD-9MMFM	SD-9MMDM	SD-9MMCB	-

* Solid Carbide * 슬리드 카바이드

SE BURS - OVAL SHAPE

SE 버 - 타원형

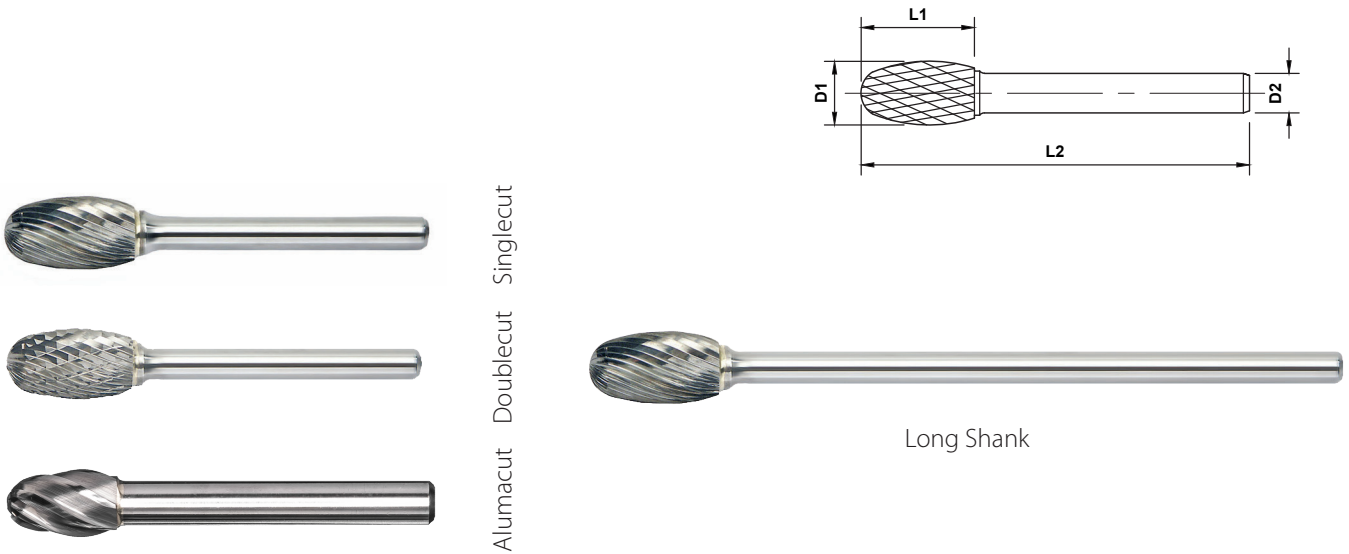

Length Key (K)

Standard Long * Solid Carbide

Quick Ship Items

Non-Ferrous **N** Alumacuts recommended for non-ferrous materials

Cast Iron **K** Titanium **S** Stainless **M** Steel **P** Hardened **H**

	OD	LOC	SHK	OAL	Cut Type					
	D1	L1	D2	L2	Singlecut	Doublecut	Alumacut	Diamondcut	Chipbreaker	NX Cut
*	3	5.5	3	38	SE-41MMSC	SE-41MMDC	SE-41MMFM	SE-41MMDM	SE-41MMCB	-
		5.5	3	50	SE-41MML2SC	SE-41MML2DC	SE-41MML2FM	SE-41MML2DM	SE-41MML2CB	-
		5.5	3	75	SE-41MML3SC	SE-41MML3DC	SE-41MML3FM	SE-41MML3DM	SE-41MML3CB	-
*	6	9.5	6	50	SE-1MMSC	SE-1MMDC	SE-1MMFM	SE-1MMDM	SE-1MMCB	-
		9.5	6	178	SE-1MML6SC	SE-1MML6DC	SE-1MML6FM	SE-1MML6DM	SE-1MML6CB	-
	6.3	9.5	3	47	SE-51MMSC	SE-51MMDC	SE-51MMFM	SE-51MMDM	SE-51MMCB	-
	9.5	16	6	61	SE-3MMSC	SE-3MMDC	SE-3MMFM	SE-3MMDM	SE-3MMCB	SE-3MMNX
		16	6	166	SE-3MML6SC	SE-3MML6DC	SE-3MML6FM	SE-3MML6DM	SE-3MML6CB	-
	12.7	22	6	67	SE-5MMSC	SE-5MMDC	SE-5MMFM	SE-5MMDM	SE-5MMCB	SE-5MMNX
		22	6	172	SE-5MML6SC	SE-5MML6DC	SE-5MML6FM	SE-5MML6DM	SE-5MML6CB	-
	16	25	6	70	SE-6MMSC	SE-6MMDC	SE-6MMFM	SE-6MMDM	SE-6MMCB	-
	19	25	6	70	SE-7MMSC	SE-7MMDC	SE-7MMFM	SE-7MMDM	SE-7MMCB	-

* Solid Carbide • *슬리드 카바이드

SF BURS - RADIUS TREE SHAPE

SF 버 - 반경 트리형



Alumacut Doublecut Singlecut



Long Shank

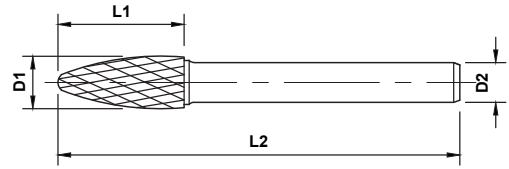

Length Key (K)

Standard Long * Solid Carbide

Quick Ship Items

Non-Ferrous **N** Alumacuts recommended for non-ferrous materials

Cast Iron **K** Titanium **S** Stainless **M** Steel **P** Hardened **H**

	OD	LOC	SHK	OAL	Cut Type					
					D1	L1	D2	L2	Singlecut	Doublecut
*	3	6	3	38	SF-41MMSC	SF-41MMDC	SF-41MMFM	SF-41MMDM	SF-41MMCB	-
		12.7	3	38	SF-42MMSC	SF-42MMDC	SF-42MMFM	SF-42MMDM	SF-42MMCB	-
		12.7	3	50	SF-42MML2SC	SF-42MML2DC	SF-42MML2FM	SF-42MML2DM	SF-42MML2CB	-
		12.7	3	75	SF-42MML3SC	SF-42MML3DC	SF-42MML3FM	SF-42MML3DM	SF-42MML3CB	-
*	6	16	6	50	SF-1MMSC	SF-1MMDC	SF-1MMFM	SF-1MMDM	SF-1MMCB	-
		16	6	172	SF-1MML6SC	SF-1MML6DC	SF-1MML6FM	SF-1MML6DM	SF-1MML6CB	-
	6.3	12.7	3	50	SF-51MMSC	SF-51MMDC	SF-51MMFM	SF-51MMDM	SF-51MMCB	-
		19	6	64	SF-3MMSC	SF-3MMDC	SF-3MMFM	SF-3MMDM	SF-3MMCB	SF-3MMNX
	9.5	19	6	169	SF-3MML6SC	SF-3MML6DC	SF-3MML6FM	SF-3MML6DM	SF-3MML6CB	-
		25	6	70	SF-4MMSC	SF-4MMDC	SF-4MMFM	SF-4MMDM	SF-4MMCB	-
	11	19	6	64	SF-13MMSC	SF-13MMDC	SF-13MMFM	SF-13MMDM	SF-13MMCB	-
		25	6	70	SF-5MMSC	SF-5MMDC	SF-5MMFM	SF-5MMDM	SF-5MMCB	SF-5MMNX
		25	6	175	SF-5MML6SC	SF-5MML6DC	SF-5MML6FM	SF-5MML6DM	SF-5MML6CB	-
	16	25	6	70	SF-6MMSC	SF-6MMDC	SF-6MMFM	SF-6MMDM	SF-6MMCB	-
		32	6	77	SF-14MMSC	SF-14MMDC	SF-14MMFM	SF-14MMDM	SF-14MMCB	-
		38	6	83	SF-15MMSC	SF-15MMDC	SF-15MMFM	SF-15MMDM	SF-15MMCB	-
	19	25	6	70	SF-7MMSC	SF-7MMDC	SF-7MMFM	SF-7MMDM	SF-7MMCB	-

* Solid Carbide *솔리드 카바이드

SG BURS - POINTED TREE SHAPE

SG 버 - 뾰족한 트리형

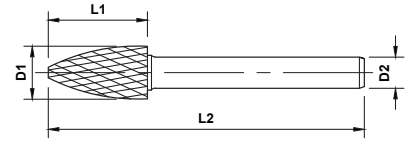

Alumacut Singlecut
Alumacut Doublecut
Alumacut



Long Shank

Length Key (K)

Standard Long * Solid Carbide

Quick Ship Items

Non-Ferrous **N** Alumacuts recommended for non-ferrous materials

Cast Iron **K** Titanium **S** Stainless **M** Steel **P** Hardened **H**

	OD	LOC	SHK	OAL	Cut Type					
					D1	L1	D2	L2	Singlecut	Doublecut
*	3	6	3	38	SG-41MMSC	SG-41MMDC	SG-41MMFM	SG-41MMDM	SG-41MMCB	-
		9.5	3	38	SG-43MMSC	SG-43MMDC	SG-43MMFM	SG-43MMDM	SG-43MMCB	-
		12.7	3	38	SG-44MMSC	SG-44MMDC	SG-44MMFM	SG-44MMDM	SG-44MMCB	-
		12.7	3	50	SG-44MML2SC	SG-44MML2DC	SG-44MML2FM	SG-44MML2DM	SG-44MML2CB	-
		12.7	3	75	SG-44MML3SC	SG-44MML3DC	SG-44MML3FM	SG-44MML3DM	SG-44MML3CB	-
6	16	6	50	SG-1MMSC	SG-1MMDC	SG-1MMFM	SG-1MMDM	SG-1MMCB	-	
	16	6	163	SG-1MML6SC	SG-1MML6DC	SG-1MML6FM	SG-1MML6DM	SG-1MML6CB	-	
6.3	12.7	3	50	SG-51MMSC	SG-51MMDC	SG-51MMFM	SG-51MMDM	SG-51MMCB	-	
	8	6	64	SG-2MMSC	SG-2MMDC	SG-2MMFM	SG-2MMDM	SG-2MMCB	-	
9.5	19	6	64	SG-3MMSC	SG-3MMDC	SG-3MMFM	SG-3MMDM	SG-3MMCB	SG-3MMNX	
	19	6	169	SG-3MML6SC	SG-3MML6DC	SG-3MML6FM	SG-3MML6DM	SG-3MML6CB	-	
12.7	19	6	64	SG-13MMSC	SG-13MMDC	SG-13MMFM	SG-13MMDM	SG-13MMCB	-	
	25	6	70	SG-5MMSC	SG-5MMDC	SG-5MMFM	SG-5MMDM	SG-5MMCB	SG-5MMNX	
	25	6	175	SG-5MML6SC	SG-5MML6DC	SG-5MML6FM	SG-5MML6DM	SG-5MML6CB	-	
16	25	6	70	SG-6MMSC	SG-6MMDC	SG-6MMFM	SG-6MMDM	SG-6MMCB	-	
	19	25	6	70	SG-7MMSC	SG-7MMDC	SG-7MMFM	SG-7MMDM	SG-7MMCB	-

* Solid Carbide • *솔리드 카바이드

SH BURS - FLAME SHAPE

SH 버 - 불꽃형

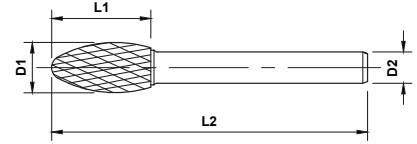

Singlecut
Doublecut
Alumacut



Long Shank

Length Key (K)

Standard Long * Solid Carbide

Quick Ship Items

Non-Ferrous **N** Alumacuts recommended for non-ferrous materials

Cast Iron **K** Titanium **S** Stainless **M** Steel **P** Hardened **H**

	OD	LOC	SHK	OAL	Cut Type					
					D1	L1	D2	L2	Singlecut	Doublecut
*	3	6.3	3	38	SH-41MMSC	SH-41MMDC	SH-41MMFM	SH-41MMDM	SH-41MMCB	-
		6.3	3	50	SH-41MML2SC	SH-41MML2DC	SH-41MML2FM	SH-41MML2DM	SH-41MML2CB	-
		6.3	3	75	SH-41MML3SC	SH-41MML3DC	SH-41MML3FM	SH-41MML3DM	SH-41MML3CB	-
*	6	12.7	6	50	SH-1MMSC	SH-1MMDC	SH-1MMFM	SH-1MMDM	SH-1MMCB	-
		12.7	6	178	SH-1MML6SC	SH-1MML6DC	SH-1MML6FM	SH-1MML6DM	SH-1MML6CB	-
	8	19	6	64	SH-2MMSC	SH-2MMDC	SH-2MMFM	SH-2MMDM	SH-2MMCB	SH-2MMNX
		19	6	169	SH-2MML6SC	SH-2MML6DC	SH-2MML6FM	SH-2MML6DM	SH-2MML6CB	-
	12.7	32	6	77	SH-5MMSC	SH-5MMDC	SH-5MMFM	SH-5MMDM	SH-5MMCB	SH-5MMNX
		32	6	182	SH-5MML6SC	SH-5MML6DC	SH-5MML6FM	SH-5MML6DM	SH-5MML6CB	-
	16	36	6	81	SH-6MMSC	SH-6MMDC	SH-6MMFM	SH-6MMDM	SH-6MMCB	-
	19	41	6	86	SH-7MMSC	SH-7MMDC	SH-7MMFM	SH-7MMDM	SH-7MMCB	-

* Solid Carbide • *솔리드 카바이드

SJ BURS - 60° INCLUDED CONE SHAPE

SJ 버 - 60° 포함 원뿔형

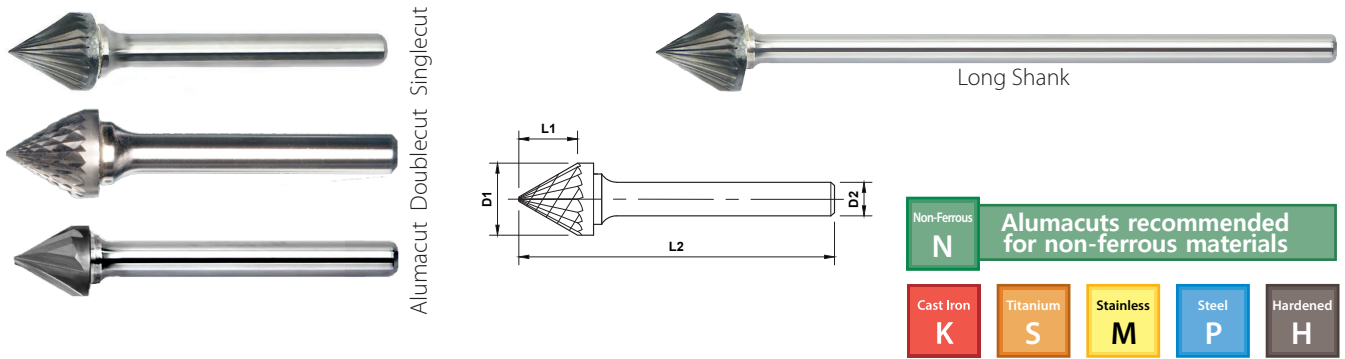

	OD				Cut Type					
	D1	L1	D2	L2	Singlecut	Doublecut	Alumacut	Diamondcut	Chipbreaker	
*	3	2.5	3	38		SJ-42MMSC	SJ-42MMDC	SJ-42MMFM	SJ-42MMDM	SJ-42MMCB
		2.5	3	38	^	SJ-42MMDESC ^	SJ-42MMDEDC ^	SJ-42MMDEFM ^	SJ-42MMDEDM ^	SJ-42MMDECB ^
*	6	4	6	50		SJ-1MMDESC ^	SJ-1MMDEDC ^	SJ-1MMDEFM ^	SJ-1MMDEDM ^	SJ-1MMDECB ^
		4	6	50		SJ-1MMSC	SJ-1MMDC	SJ-1MMFM	SJ-1MMDM	SJ-1MMCB
	9.5	8	6	53		SJ-3MMSC	SJ-3MMDC	SJ-3MMFM	SJ-3MMDM	SJ-3MMCB
	12.7	11	6	56		SJ-5MMSC	SJ-5MMDC	SJ-5MMFM	SJ-5MMDM	SJ-5MMCB
	16	14.5	6	59.5		SJ-6MMSC	SJ-6MMDC	SJ-6MMFM	SJ-6MMDM	SJ-6MMCB
	19	17.5	6	62.5		SJ-7MMSC	SJ-7MMDC	SJ-7MMFM	SJ-7MMDM	SJ-7MMCB
	25	24.5	6	69.5		SJ-9MMSC	SJ-9MMDC	SJ-9MMFM	SJ-9MMDM	SJ-9MMCB

* Solid Carbide • *솔리드 카바이드 ^ Double End • ^ 더블 엔드

SK BURS - 90° INCLUDED CONE SHAPE

SK 버 - 90° 포함 원뿔형

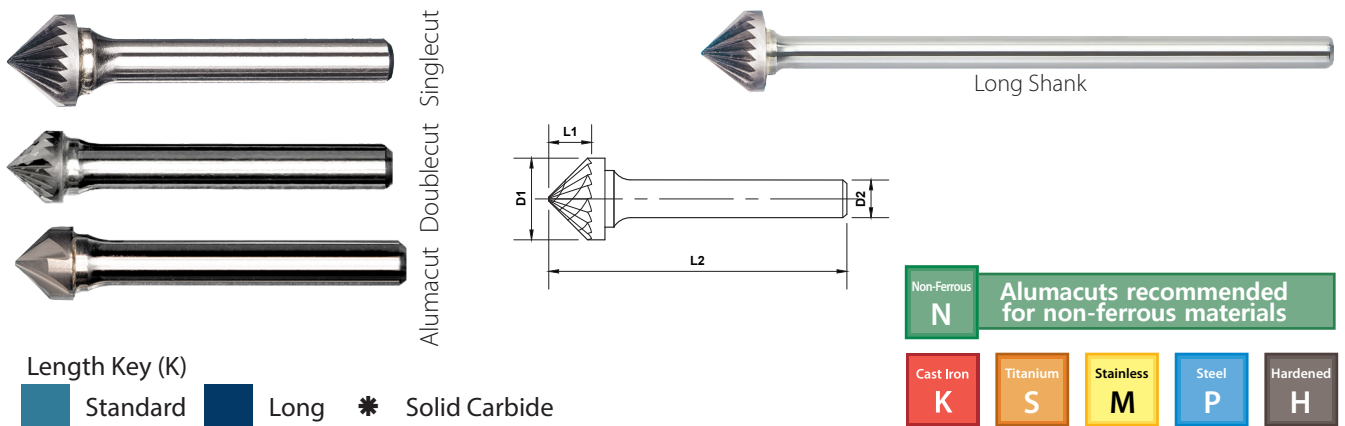

Length Key (K)

Standard Long * Solid Carbide

	OD				Cut Type					
	D1	L1	D2	L2	Singlecut	Doublecut	Alumacut	Diamondcut	Chipbreaker	
*	3	1.5	3	38		SK-42MMSC	SK-42MMDC	SK-42MMFM	SK-42MMDM	SK-42MMCB
		1.5	3	38	^	SK-42MMSCDE ^	SK-42MMDEDC ^	SK-42MMDEFM ^	SK-42MMDEDM ^	SK-42MMDECB ^
*	6	3	6	50		SK-1MMSC	SK-1MMDC	SK-1MMFM	SK-1MMDM	SK-1MMCB
		3	6	50	^	SK-1MMDESC ^	SK-1MMDEDC ^	SK-1MMDEFM ^	SK-1MMDEDM ^	SK-1MMDECB ^
	9.5	4.7	6	49.7		SK-3MMSC	SK-3MMDC	SK-3MMFM	SK-3MMDM	SK-3MMCB
	12.7	6.3	6	51.3		SK-5MMSC	SK-5MMDC	SK-5MMFM	SK-5MMDM	SK-5MMCB
	16	8	6	53		SK-6MMSC	SK-6MMDC	SK-6MMFM	SK-6MMDM	SK-6MMCB
	19	9.5	6	54.5		SK-7MMSC	SK-7MMDC	SK-7MMFM	SK-7MMDM	SK-7MMCB
	25	12.7	6	57.7		SK-9MMSC	SK-9MMDC	SK-9MMFM	SK-9MMDM	SK-9MMCB

* Solid Carbide • *솔리드 카바이드 ^ Double End • ^ 더블 엔드

SL BURS - RADIUS CONE SHAPE

SL 버 - 반경 원뿔형

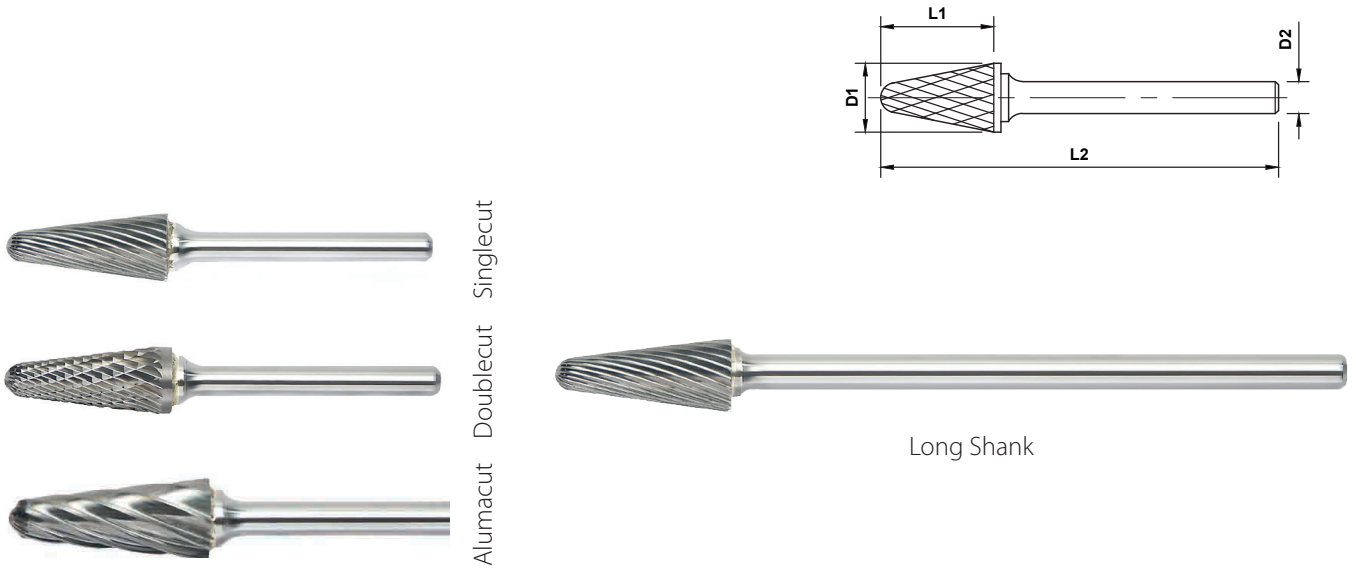

Length Key (K)

Standard Long * Solid Carbide

Quick Ship Items

Non-Ferrous **N** Alumacuts recommended for non-ferrous materials

Cast Iron **K** Titanium **S** Stainless **M** Steel **P** Hardened **H**

	Length Key (K)				Inclusive Angle	Cut Type					
	OD	LOC	SHK	OAL		Singlecut	Doublecut	Alumacut	Diamondcut	Chipbreaker	NX Cut
	D1	L1	D2	L2	DEG °						
* 3	9.5	3	38	8°	SL-41MMSC	SL-41MMDC	SL-41MMFM	SL-41MMDM	SL-41MMCB	-	
	12.7	3	38	8°	SL-42MMSC	SL-42MMDC	SL-42MMFM	SL-42MMDM	SL-42MMCB	-	
* 6	16	6	50	14°	SL-1MMSC	SL-1MMDC	SL-1MMFM	SL-1MMDM	SL-1MMCB	-	
	16	6	166	14°	SL-1MML6SC	SL-1MML6DC	SL-1MML6FM	SL-1MML6DM	SL-1MML6CB	-	
8	22	6	67	14°	SL-2MMSC	SL-2MMDC	SL-2MMFM	SL-2MMDM	SL-2MMCB	-	
9.5	27	6	72	14°	SL-3MMSC	SL-3MMDC	SL-3MMFM	SL-3MMDM	SL-3MMCB	SL-3MMNX	
	27	6	177	14°	SL-3MML6SC	SL-3MML6DC	SL-3MML6FM	SL-3MML6DM	SL-3MML6CB	-	
12.7	28	6	73	14°	SL-4MMSC	SL-4MMDC	SL-4MMFM	SL-4MMDM	SL-4MMCB	SL-4MMNX	
	28	6	178	14°	SL-4MML6SC	SL-4MML6DC	SL-4MML6FM	SL-4MML6DM	SL-4MML6CB	-	
16	30	6	75	14°	SL-5MMSC	SL-5MMDC	SL-5MMFM	SL-5MMDM	SL-5MMCB	-	
	33	6	78	14°	SL-6MMSC	SL-6MMDC	SL-6MMFM	SL-6MMDM	SL-6MMCB	-	
19	38	6	83	14°	SL-7MMSC	SL-7MMDC	SL-7MMFM	SL-7MMDM	SL-7MMCB	-	

* Solid Carbide • *솔리드 카바이드

SM BURS - POINTED CONE SHAPE

SM 버 - 뾰족한 원뿔형



Singlecut
Doublecut
Alumacut

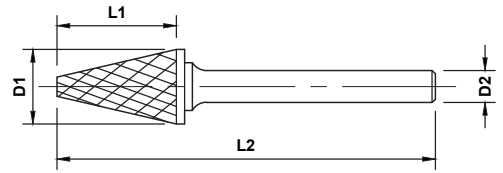

Long Shank

BURS

Length Key (K)

Standard Long * Solid Carbide

Quick Ship Items

Non-Ferrous **N** Alumacuts recommended for non-ferrous materials

Cast Iron **K** Titanium **S** Stainless **M** Steel **P** Hardened **H**

	Length Key (K)				Inclusive Angle	Cut Type					
	OD	LOC	SHK	OAL		deg	Singlecut	Doublecut	Alumacut	Diamondcut	Chipbreaker
* * * * *	3		8.9	3	38	12°	SM-41MMSC	SM-41MMDC	SM-41MMFM	SM-41MMDM	SM-41MMCB
			11	3	38	14°	SM-42MMSC	SM-42MMDC	SM-42MMFM	SM-42MMDM	SM-42MMCB
			11	3	50	14°	SM-42MML2SC	SM-42MML2DC	SM-42MML2FM	SM-42MML2DM	SM-42MML2CB
			11	3	75	14°	SM-42MML3SC	SM-42MML3DC	SM-42MML3FM	SM-42MML3DM	SM-42MML3CB
			16	3	38	7°	SM-43MMSC	SM-43MMDC	SM-43MMFM	SM-43MMDM	SM-43MMCB
* * * * *	6		12.7	6	50	12°	SM-1MMSC	SM-1MMDC	SM-1MMFM	SM-1MMDM	SM-1MMCB
			19	6	50	14°	SM-2MMSC	SM-2MMDC	SM-2MMFM	SM-2MMDM	SM-2MMCB
			25	6	50	12°	SM-3MMSC	SM-3MMDC	SM-3MMFM	SM-3MMDM	SM-3MMCB
		6.3	12.7	3	54	22°	SM-51MMSC	SM-51MMDC	SM-51MMFM	SM-51MMDM	SM-51MMCB
		9.5	16	6	61	28°	SM-4MMSC	SM-4MMDC	SM-4MMFM	SM-4MMDM	SM-4MMCB
	12.7	22	6	67	28°	SM-5MMSC	SM-5MMDC	SM-5MMFM	SM-5MMDM	SM-5MMCB	
	16	25	6	70	31°	SM-6MMSC	SM-6MMDC	SM-6MMFM	SM-6MMDM	SM-6MMCB	

* Solid Carbide • *슬리드 카바이드

SN BURS - INVERTED CONE SHAPE

SN 버 - 역원뿔형

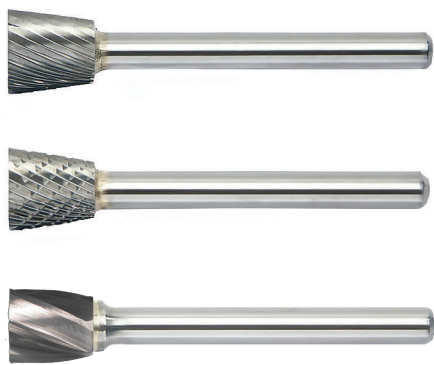

Singlecut
Doublecut
Alumacut

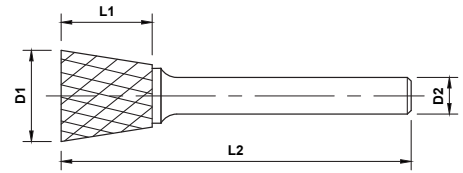

Long Shank

Length Key (K)

Standard Long * Solid Carbide

Non-Ferrous **N** Alumacuts recommended for non-ferrous materials

Cast Iron **K** Titanium **S** Stainless **M** Steel **P** Hardened **H**

	OD	LOC	SHK	OAL	Inclusive Angle	Cut Type				
	D1	L1	D2	L2	Deg °	Singlecut	Doublecut	Alumacut	Diamondcut	Chipbreaker
*	2.5	3	3	38	10°	SN-41MMSC	SN-41MMDC	SN-41MMFM	SN-41MMDM	SN-41MMCB
*	3	4	3	38	10°	SN-42MMSC	SN-42MMDC	SN-42MMFM	SN-42MMDM	SN-42MMCB
*	6	8	6	50	10°	SN-1MMSC	SN-1MMDC	SN-1MMFM	SN-1MMDM	SN-1MMCB
	6.3	6	3	44	10°	SN-51MMSC	SN-51MMDC	SN-51MMFM	SN-51MMDM	SN-51MMCB
	9.5	9.5	6	54.5	13°	SN-2MMSC	SN-2MMDC	SN-2MMFM	SN-2MMDM	SN-2MMCB
	12.7	12.7	6	57.7	28°	SN-4MMSC	SN-4MMDC	SN-4MMFM	SN-4MMDM	SN-4MMCB
	16	19	6	64	18°	SN-6MMSC	SN-6MMDC	SN-6MMFM	SN-6MMDM	SN-6MMCB
	19	16	6	61	30°	SN-7MMSC	SN-7MMDC	SN-7MMFM	SN-7MMDM	SN-7MMCB

* Solid Carbide • *솔리드 카바이드

FIBERGLASS ROUTERS

유리섬유 라우터



Plain end

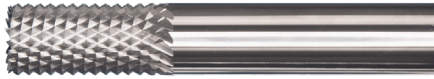

Burend

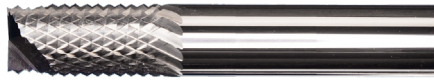

Millend



Drill end

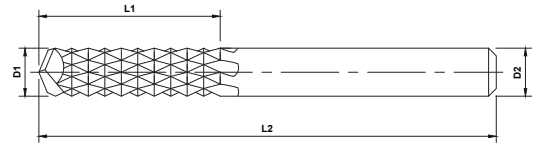

Length Key (K)

Standard Long * Solid Carbide

	OD	LOC	SHK	OAL	End Cut Type			
	D1	L1	D2	L2	Plain end(A)	Burend (B)	Millend (C)	Drill end (D)
Standard	2	10	3	38	FGRM1-1A	FGRM1-1B	FGRM1-1C	FGRM1-1D
	1.5	5	3	38	FGRM1A	FGRM1B	FGRM1C	FGRM1D
	3	12	3	38	FGRM2A	FGRM2B	FGRM2C	FGRM2D
	5	16	5	50	FGRM3A	FGRM3B	FGRM3C	FGRM3D
		16	6	50	FGRM4A	FGRM4B	FGRM4C	FGRM4D
	6	18	6	50	FGRM5A	FGRM5B	FGRM5C	FGRM5D
		25	6	63	FGRM6-0A	FGRM6-0B	FGRM6-0C	FGRM6-0D
		18	6	75	FGRM6-1A	FGRM6-1B	FGRM6-1C	FGRM6-1D
		25	6	75	FGRM6-2A	FGRM6-2B	FGRM6-2C	FGRM6-2D
		38	6	75	FGRM6-3A	FGRM6-3B	FGRM6-3C	FGRM6-3D
		18	6	63	FGRM6A	FGRM6B	FGRM6C	FGRM6D
	8	25	8	63	FGRM7A	FGRM7B	FGRM7C	FGRM7D
10	25	10	63	FGRM8A	FGRM8B	FGRM8C	FGRM8D	
12	25	12	75	FGRM9A	FGRM9B	FGRM9C	FGRM9D	

DIEMILLS

Diemills



Doublecut

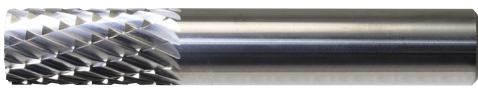

Coarse
Doublecut

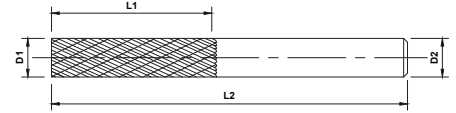

* Solid Carbide • *솔리드 카바이드

Length Key (K)

Standard Long * Solid Carbide



	OD	LOC	SHK	OAL	Cut Type	
	D1	L1	D2	L2	Doublecut	Coarse Doublecut
*	3	12	3	38	M48000	M48020
*	4	12	4	50	M48100	M48120
*	5	16	5	50	M48200	M48220
*	6	18	6	50	M48300	M48320
*	8	22	8	63	M48400	M48420
*	10	25	10	63	M48500	M48520

* Solid Carbide • *솔리드 카바이드

PILOTED DIEMILLS

Piloted Diemills



Doublecut



Singlecut

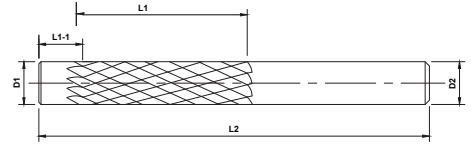

BURS

Length Key (K)

Standard Long * Solid Carbide

Cast Iron
K
Titanium
S
Stainless
M
Steel
P
Hardened
H

	OD	LOC	Pilot	SHK	OAL	Cut Type	
	D1	L1	L1-1	D2	L2	Doublecut	Singlecut
*	3	25	3	3	75	M22000	M22001
*	5	32	5	5	75	M22100	M22101
*	6	32	6	6	75	M22200	M22201
*	10	50	10	10	100	M22300	M22301
*	12	50	12	12	100	M22400	M22401

* Solid Carbide • *솔리드 카바이드

TIRE BURS

타이어 버

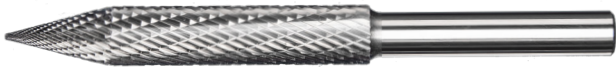
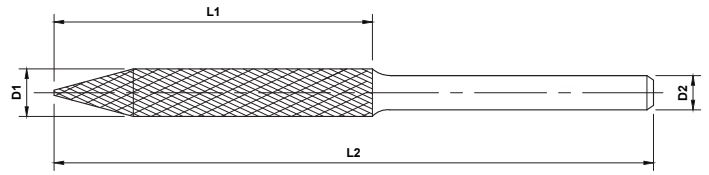

Round Shank

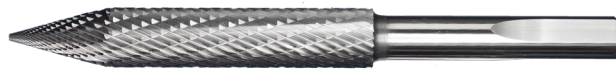

Tri-Shank

Length Key (K)

Standard Long * Solid Carbide

Steel
P

OD	LOC	SHK	OAL	Shank Type	
				Round Shank	Tri-Shank
D1	L1	D2	L2	Round Shank	Tri-Shank
3	25	3	50	STBM-011	-
	14	3	38	STBM-012	STBM-012T
6	50	6	75	STBM-013	STBM-013T
8	53	8	100	STBM-014	STBM-014T
10	75	10	100	STBM-015	STBM-015T

PLASTIC POUCH BUR SETS

플라스틱 파우치 버 세트



Power Pouch Bur Sets	
Part ID	Description
SETM640MMDC	Plastic Pouch Set SC3MML6, SD3MML6, SF3MML6, SF5MML6 Doublecut
SETM640MMDM	Plastic Pouch Set SC3MML6, SD3MML6, SF3MML6, SF5MML6 Diamond Cut
SETM640MMFM	Plastic Pouch Set SC3MML6, SD3MML6, SF3MML6, SF5MML6 Alumacut
SETM640MMSC	Plastic Pouch Set SC3MML6, SD3MML6, SF3MML6, SF5MML6 Singlecut

All tools in these sets are 6mm diameter shank. •이 세트의 모든 공구는 직경 6mm의 샹크입니다.

12 PIECE PLASTIC BOX BUR SETS

12조 플라스틱 박스 버 세트



Plastic Box Bur Set			
SD	Burs Shapes Included	Cut Type	Part ID
3mm	SA43MM, SA42MM, SC42MM, SC41MM, SD42MM, SE41MM, SF41MM, SG41MM, SH41MM, SJ42MM, SL42MM, SN42MM	Doublecut	SETM100MPPDC
3mm	SA43MM, SA42MM, SC42MM, SC41MM, SD42MM, SE41MM, SF41MM, SG41MM, SH41MM, SJ42MM, SL42MM, SN42MM	Diamondcut	SETM100MPPDM
3mm	SA43MM, SA42MM, SC42MM, SC41MM, SD42MM, SE41MM, SF41MM, SG41MM, SH41MM, SJ42MM, SL42MM, SN42MM	Singlecut	SETM100MPPSC
6mm	SA1MM, SC1MM, SD1MM, SE1MM, SF1MM, SG1MM, SH1MM, SJ1MM, SK1MM, SL1MM, SM1MM, SN1MM	Doublecut	SETM120MPPDC
6mm	SA1MM, SC1MM, SD1MM, SE1MM, SF1MM, SG1MM, SH1MM, SJ1MM, SK1MM, SL1MM, SM1MM, SN1MM	Diamondcut	SETM120MPPDM
6mm	SA1MM, SC1MM, SD1MM, SE1MM, SF1MM, SG1MM, SH1MM, SJ1MM, SK1MM, SL1MM, SM1MM, SN1MM	Singlecut	SETM120MPPSC

SD= Shank Diameter • SD = 생크 직경

24 PIECE COUNTERTOP DISPLAYS

24조 카운터톱 디스플레이



Description	Burs Included	Part Number
24 Piece Display Metric Bur Set	SA-5MMDC, SA-3MMDC, SA-1MMDC, SC-5MMDC, SC-3MMDC, SC-1MMDC, SD-5MMDC, SD-3MMDC, SD-1MMDC, SE-5MMDC, SE-3MMDC, SE-1MMDC, SF-5MMDC, SF-3MMDC, SF-1MMDC, SG-5MMDC, SG-3MMDC, SG-1MMDC, SL-4MMDC, SL-3MMDC, SL-1MMDC, SM-5MMDC, SM-4MMDC, SM-3MMDC	DISPLAY2M
24 Piece Metric Bur Set without Display	All Burs Above	DIS24M-ND

All tools in these sets are 6mm diameter shank. • 이 세트의 모든 공구는 직경 6mm의 생크입니다.

FRACTIONAL PRODUCTS

프랙셔널 제품



**“Our Best Selling Fractional
Dimension Tools!”**

“프랙셔널 차원의 베스트셀러
공구!”

SUPERIOR CARBIDE BLEND

탁월한 카바이드 혼합

Mastercut's Superior Carbide Blend – A-Gr-SiV (Active Grain Sized Volume)

Our superior tungsten carbide gives you the ability to be *aggressive* when you need to be. Growth inhibitors in our submicron carbide blanks maintain the most consistent grain size available, giving you superior hardness and toughness.

Mastercut의 탁월한 카바이드 혼합 – A-Gr-SiV(액티브 결정 입도 볼륨)

당사의 우수한 텅스텐 카바이드는 귀하가 필요할 때 공격적으로 대응할 수 있는 능력을 제공합니다. 당사의 서브 마이크론 카바이드 블랭크의 성장 억제제는 가장 균일한 결정 입도를 유지하며, 탁월한 경도와 인성을 제공합니다.

Full line of fractional products available
플라인 프랙셔널 제품 사용 가능

LEGENDS















	Alumacuts recommended for non-ferrous materials
	비철금속 재료에 권장되는 알루마컷

Fractional Products
프랙셔널 제품

Email: sales@mastercuttool.com
www.mastercuttool.com

















TABLE OF CONTENTS - 목차

	Fractional Square Endmills 프랙셔널 스퀘어 엔드밀 160	Cermet	Cast Iron K	Titanium S	Non-Ferrous N	Stainless M	Steel P
	Fractional Ball Endmills 프랙셔널 볼 엔드밀 161	Cermet	Cast Iron K	Titanium S	Non-Ferrous N	Stainless M	Steel P
	Fractional Corner Radius Endmills 프랙셔널 코너 반경 엔드밀 162	Cermet	Cast Iron K	Titanium S	Non-Ferrous N	Stainless M	Steel P
	Fractional 90° Drill Mills 프랙셔널 90° 드릴 밀 163	Cermet	Cast Iron K	Titanium S	Non-Ferrous N	Stainless M	Steel P
	Fractional Square End Mini Mills 프랙셔널 스퀘어 엔드 미니 밀 164	Cermet	Cast Iron K	Titanium S	Non-Ferrous N	Stainless M	Steel P
	Fractional Ball End Mini Mills 프랙셔널 볼 엔드 미니 밀 165	Cermet	Cast Iron K	Titanium S	Non-Ferrous N	Stainless M	Steel P
	Fractional V4 Square Endmills 프랙셔널 V4 스퀘어 엔드밀 166	Cermet	Hardened H	Cast Iron K	Titanium S	Stainless M	Steel P
	Fractional V4 Ball Endmills 프랙셔널 V4 볼 엔드밀 167	Cermet	Hardened H	Cast Iron K	Titanium S	Stainless M	Steel P
	Fractional V4 Corner Radius Endmills 프랙셔널 V4 코너 반경 엔드밀 168	Cermet	Hardened H	Cast Iron K	Titanium S	Stainless M	Steel P
	Fractional V5 Square Endmills 프랙셔널 V5 스퀘어 엔드밀 169	Cermet	Hardened H	Cast Iron K	Titanium S	Stainless M	Steel P
	Fractional V5 Ball Endmills 프랙셔널 V5 볼 엔드밀 170	Cermet	Hardened H	Cast Iron K	Titanium S	Stainless M	Steel P
	Fractional V5 Corner Radius Endmills 프랙셔널 V5 코너 반경 엔드밀 171	Cermet	Hardened H	Cast Iron K	Titanium S	Stainless M	Steel P
	Fractional F45 6 Flute Square Endmills 프랙셔널 F45 6 플루트 스퀘어 엔드밀 172	Cermet	Hardened H	Cast Iron K	Titanium S	Stainless M	Steel P
	Fractional F45 6 Flute Corner Radius Endmills 프랙셔널 F45 6 플루트 코너 반경 엔드밀 173	Cermet	Hardened H	Cast Iron K	Titanium S	Stainless M	Steel P

Fractional Products 프랙셔널 제품

TABLE OF CONTENTS - 목차

	Fractional Square End AxMills 프랙셔널 스퀘어 엔드 악스밀..... 174								Non-Ferrous N
	Fractional Jobber Drills 프랙셔널 자버 드릴..... 175	Cermet	Hardened H	Cast Iron K	Titanium S	Non-Ferrous N	Stainless M	Steel P	
	Fractional Spade Drills 프랙셔널 스페이드 드릴..... 178	Cermet	Hardened H	Cast Iron K	Titanium S	Non-Ferrous N	Stainless M	Steel P	
	Fractional NC Spotting Drills 프랙셔널 NC 스폿팅 드릴..... 179	Cermet	Hardened H	Cast Iron K	Titanium S	Non-Ferrous N	Stainless M	Steel P	
	Fractional Drill and Countersink/Centerdrill 프랙셔널 드릴 및 카운터싱크/센터드릴..... 180	Cermet	Hardened H	Cast Iron K	Titanium S	Non-Ferrous N	Stainless M	Steel P	
	Fractional SA Bur - Cylindrical Shape without End Cut 프랙셔널 SA 버 - 엔드 컷 없는 원통형..... 181		Hardened H	Cast Iron K		Non-Ferrous N	Stainless M	Steel P	
	Fractional SB Bur - Cylindrical with Endcut 프랙셔널 SB 버 - 엔드 컷 있는 원통형..... 182		Hardened H	Cast Iron K		Non-Ferrous N	Stainless M	Steel P	
	Fractional SC Bur - Radius Cylindrical Shape 프랙셔널 SC 버 - 반경 원통형..... 183		Hardened H	Cast Iron K		Non-Ferrous N	Stainless M	Steel P	
	Fractional SD Bur - Ball Shape 프랙셔널 SD 버 - 볼형..... 184		Hardened H	Cast Iron K		Non-Ferrous N	Stainless M	Steel P	
	Fractional SE Bur - Oval Shape 프랙셔널 SE 버 - 타원형..... 185		Hardened H	Cast Iron K		Non-Ferrous N	Stainless M	Steel P	
	Fractional SF Bur - Radius Tree Shape 프랙셔널 SF 버 - 반경 트리형..... 186		Hardened H	Cast Iron K		Non-Ferrous N	Stainless M	Steel P	
	Fractional SG Bur - Pointed Tree Shape 프랙셔널 SG 버 - 뾰족한 트리형..... 187		Hardened H	Cast Iron K		Non-Ferrous N	Stainless M	Steel P	
	Fractional SH Bur - Flame Shape 프랙셔널 SH 버 - 불꽃형..... 187		Hardened H	Cast Iron K		Non-Ferrous N	Stainless M	Steel P	
	Fractional SL Bur - Radius Cone Shape 프랙셔널 SL 버 - 반경 원뿔형..... 188		Hardened H	Cast Iron K		Non-Ferrous N	Stainless M	Steel P	
	Fractional SM Bur - Pointed Cone Shape 프랙셔널 SM 버 - 뾰족한 원뿔형..... 189		Hardened H	Cast Iron K		Non-Ferrous N	Stainless M	Steel P	

Fractional Products
프랙셔널 제품

SQUARE ENDMILLS

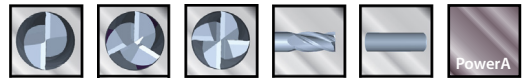

스퀘어 엔드밀

2, 3 and 4 Flutes	Coated and Uncoated
2, 3 및 4 플루트	코팅 및 비코팅

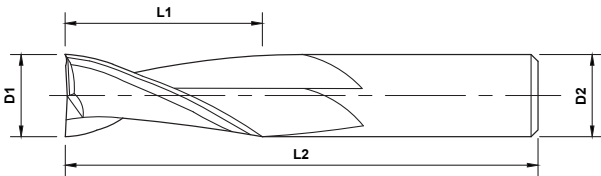

Standard, Series 209,210,211

Length Key (K)

■ Stub
 ■ Standard
 ■ Long

Quick Ship Items



OD	LOC	SHK	OAL	Uncoated			PowerA		
				2 Flute	3 Flute	4 Flute	2 Flute	3 Flute	4 Flute
D1	L1	D2	L2						
1/32	3/32	1/8	1-1/2	209-202	-	211-202	209-202-1	-	211-202-1
1/16	1/4	1/8	1-1/2	209-206	-	211-206	209-206-1	-	211-206-1
3/32	3/8	1/8	1-1/2	209-210	-	211-210	209-210-1	-	211-210-1
1/8	1/2	1/8	1-1/2	209-214	-	211-214	209-214-1	-	211-214-1
3/16	5/8	3/16	2	209-222	-	211-222	209-222-1	-	211-222-1
1/4	3/4	1/4	2-1/2	209-230	210-230	211-230	209-230-1	210-230-1	211-230-1
5/16	7/8	5/16	2-1/2	209-238	-	211-238	209-238-1	-	211-238-1
3/8	7/8	3/8	2-1/2	209-246	210-246	211-246	209-246-1	210-246-1	211-246-1
1/2	1	1/2	3	209-262	210-262	211-262	209-262-1	210-262-1	211-262-1
5/8	1-1/4	5/8	3-1/2	209-266	-	211-266	209-266-1	-	211-266-1
3/4	1-1/2	3/4	4	209-270	-	211-270	209-270-1	-	211-270-1
7/8	1-1/2	7/8	4	209-272	-	211-272	209-272-1	-	211-272-1
1	1-1/2	1	4	209-274	-	211-274	209-274-1	-	211-274-1

Fractional Products

프랙셔널 제품

BALL ENDMILLS

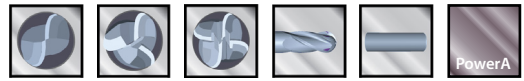

볼 엔드밀

2, 3 and 4 Flutes	Coated and Uncoated
2, 3 및 4 플루트	코팅 및 비코팅

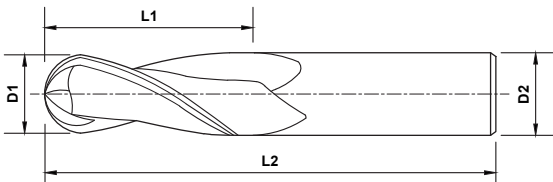

Standard, Series 209,210,211

Length Key (K)

■ Stub
 ■ Standard
 ■ Long

Quick Ship Items



	OD	LOC	SHK	OAL	Uncoated			PowerA		
					2 Flute	3 Flute	4 Flute	2 Flute	3 Flute	4 Flute
	D1	L1	D2	L2						
	1/32	3/32	1/8	1-1/2	209-002	-	211-002	209-002-1	-	211-002-1
	1/16	1/4	1/8	1-1/2	209-006	-	211-006	209-006-1	-	211-006-1
	3/32	3/8	1/8	1-1/2	209-010	-	211-010	209-010-1	-	211-010-1
	1/8	1/2	1/8	1-1/2	209-014	-	211-014	209-014-1	-	211-014-1
	3/16	5/8	3/16	2	209-022	-	211-022	209-022-1	-	211-022-1
	1/4	3/4	1/4	2-1/2	209-030	210-030	211-030	209-030-1	210-030-1	211-030-1
	5/16	7/8	5/16	2-1/2	209-038	-	211-038	209-038-1	-	211-038-1
	3/8	7/8	3/8	2-1/2	209-046	210-046	211-046	209-046-1	210-046-1	211-046-1
	1/2	1	1/2	3	209-062	210-062	211-062	209-062-1	210-062-1	211-062-1
	5/8	1-1/4	5/8	3-1/2	209-066	-	211-066	209-066-1	-	211-066-1
	3/4	1-1/2	3/4	4	209-070	-	211-070	209-070-1	-	211-070-1
	7/8	1-1/2	7/8	4	209-072	-	211-072	209-072-1	-	211-072-1
	1	1-1/2	1	4	209-074	-	211-074	209-074-1	-	211-074-1

Fractional Products
프랙셔널 제품

CORNER RADIUS ENDMILLS

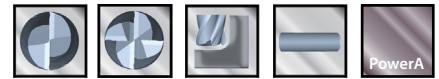

코너 반경 엔드밀

2 and 4 Flutes	Coated and Uncoated
2 및 4 플루트	코팅 및 비코팅

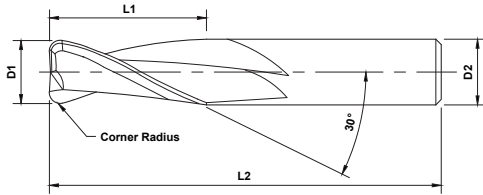

Standard, Series 209,211

Length Key (K)

■ Stub
 ■ Standard
 ■ Long

Quick Ship Items



	OD	LOC	SHK	OAL	Radius	Uncoated		PowerA	
						2 Flute	4 Flute	2 Flute	4 Flute
	D1	L1	D2	L2	R				
Standard	1/8	1/2	1/8	1-1/2	.015	209-401	211-401	209-401-1	211-401-1
		1/2	1/8	1-1/2	.020	209-402	211-402	209-402-1	211-402-1
Standard	3/16	5/8	3/16	2	.015	209-411	211-411	209-411-1	211-411-1
		5/8	3/16	2	.020	209-412	211-412	209-412-1	211-412-1
Standard	1/4	3/4	1/4	2-1/2	.015	209-421	211-421	209-421-1	211-421-1
		3/4	1/4	2-1/2	.020	209-422	211-422	209-422-1	211-422-1
		3/4	1/4	2-1/2	.030	209-423	211-423	209-423-1	211-423-1
Standard	5/16	13/16	5/16	2-1/2	.020	209-432	211-432	209-432-1	211-432-1
		13/16	5/16	2-1/2	.030	209-433	211-433	209-433-1	211-433-1
Standard	3/8	1	3/8	2-1/2	.020	209-442	211-442	209-442-1	211-442-1
		1	3/8	2-1/2	.030	209-443	211-443	209-443-1	211-443-1
Standard	1/2	1	1/2	3	.020	209-452	211-452	209-452-1	211-452-1
		1	1/2	3	.030	209-453	211-453	209-453-1	211-453-1
Standard	5/8	1-1/4	5/8	3-1/2	.030	209-463	211-463	209-463-1	211-463-1
		1-1/4	5/8	3-1/2	.045	209-464	211-464	209-464-1	211-464-1
Standard	3/4	1-1/2	3/4	4	.030	209-473	211-473	209-473-1	211-473-1
		1-1/2	3/4	4	.045	209-474	211-474	209-474-1	211-474-1
Standard	1	1-1/2	1	4	.030	209-483	211-483	209-483-1	211-483-1
		1-1/2	1	4	.045	209-484	211-484	209-484-1	211-484-1

Fractional Products

프랙셔널 제품

90° DRILL MILLS

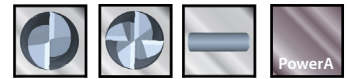

90° 드릴 밀

2 and 4 Flutes	Coated and Uncoated
2 및 4 플루트	코팅 및 비코팅

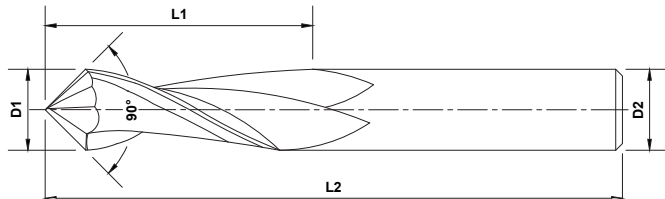

Standard, Series 214

Length Key (K)

■ Stub
 ■ Standard
 ■ Long

Quick Ship Items



	OD	LOC	SHK	OAL	Uncoated		PowerA	
					2 Flute	4 Flute	2 Flute	4 Flute
	D1	L1	D2	L2	2 Flute	4 Flute	2 Flute	4 Flute
■	1/4	3/4	1/4	2-1/2	214-006	214-306	214-006-1	214-306-1
	3/8	7/8	3/8	2-1/2	214-010	214-310	214-010-1	214-310-1
	1/2	1	1/2	3	214-014	214-314	214-014-1	214-314-1

Fractional Products
프랙셔널 제품

SQUARE MINI MILLS

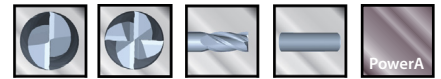

스퀘어 미니 밀

2 and 4 Flutes	Coated and Uncoated
2 및 4 플루트	코팅 및 비코팅

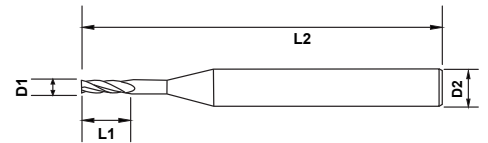
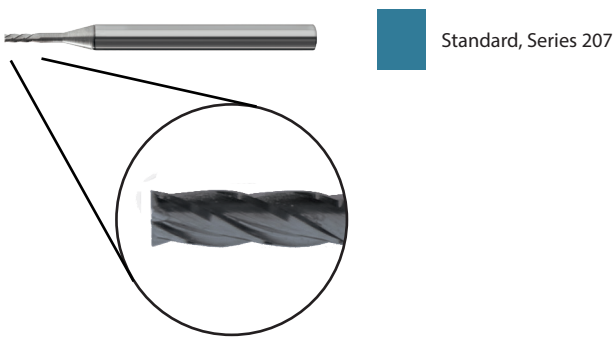

Length Key (K)

■ Stub
 ■ Standard
 ■ Long



	OD	LOC	SHK	OAL	Uncoated		PowerA	
					2 Flute	4 Flute	2 Flute	4 Flute
	D1	L1	D2	L2				
Standard	.010	.030	1/8	1-1/2	207-104	-	207-104-1	-
	.015	.045	1/8	1-1/2	207-106	-	207-106-1	-
	.020	.060	1/8	1-1/2	207-108	-	207-108-1	-
	.025	.075	1/8	1-1/2	207-110	207-510	207-110-1	207-510-1
	.030	.090	1/8	1-1/2	207-112	207-512	207-112-1	207-512-1
	.035	.105	1/8	1-1/2	207-114	207-514	207-114-1	207-514-1
	.040	.120	1/8	1-1/2	207-116	207-516	207-116-1	207-516-1
	.045	.135	1/8	1-1/2	207-118	207-518	207-118-1	207-518-1
	.050	.174	1/8	1-1/2	207-120	207-520	207-120-1	207-520-1
	.055	.267	1/8	1-1/2	207-122	207-522	207-122-1	207-522-1
	.060	.360	1/8	1-1/2	207-124	207-524	207-124-1	207-524-1

Fractional Products

프랙셔널 제품

BALL MINI MILLS

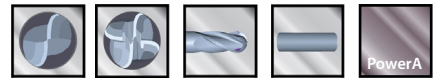

볼 미니 밀

2 and 4 Flutes	Coated and Uncoated
2 및 4 플루트	코팅 및 비코팅

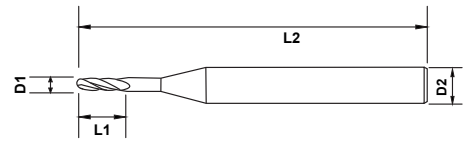
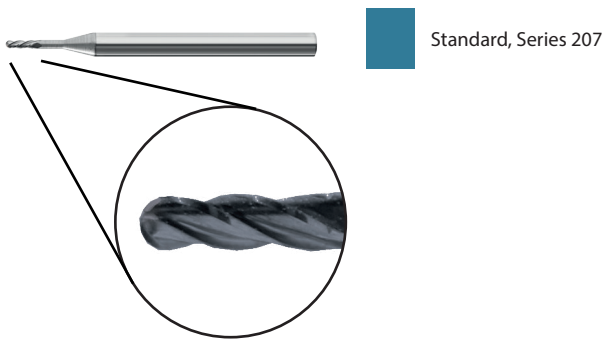

Length Key (K)

■ Stub
 ■ Standard
 ■ Long



	OD	LOC	SHK	OAL	Uncoated		PowerA	
					2 Flute	4 Flute	2 Flute	4 Flute
	D1	L1	D2	L2				
Length Key (K)	.010	.030	1/8	1-1/2	207-004	-	207-004-1	-
	.015	.045	1/8	1-1/2	207-006	-	207-006-1	-
	.020	.060	1/8	1-1/2	207-008	-	207-008-1	-
	.025	.075	1/8	1-1/2	207-010	207-410	207-010-1	207-410-1
	.030	.090	1/8	1-1/2	207-012	207-412	207-012-1	207-412-1
	.035	.105	1/8	1-1/2	207-014	207-414	207-014-1	207-414-1
	.040	.120	1/8	1-1/2	207-016	207-416	207-016-1	207-416-1
	.045	.135	1/8	1-1/2	207-018	207-418	207-018-1	207-418-1
	.050	.174	1/8	1-1/2	207-020	207-420	207-020-1	207-420-1
	.055	.267	1/8	1-1/2	207-022	207-422	207-022-1	207-422-1
	.060	.360	1/8	1-1/2	207-024	207-424	207-024-1	207-424-1

Fractional Products
프랙셔널 제품

V4 SQUARE ENDMILLS

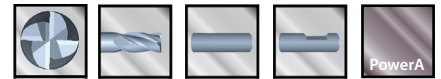

V4 스퀘어 엔드밀

4 Flutes	Coated with or without flat
4 플루트	플랫 포함 또는 플랫 없이 코팅

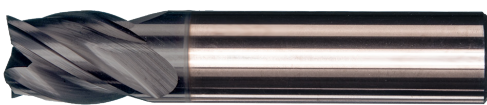
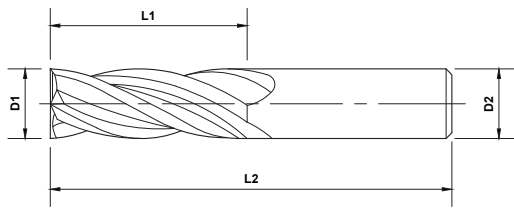

PowerA



Standard, Series 400

Length Key (K)



Quick Ship Items



	OD	LOC	SHK	OAL	PowerA	
					No Flat	With Flat
	D1	L1	D2	L2		
	1/4	5/8	1/4	2-1/2	400-010-1	-
	5/16	13/16	5/16	2-1/2	400-012-1	-
	3/8	7/8	3/8	2-1/2	400-016-1	400-016W-1
	1/2	1	1/2	3	400-022-1	400-022W-1
	5/8	1-1/4	5/8	3-1/2	400-028-1	400-028W-1
	3/4	1-1/2	3/4	4	400-030-1	400-030W-1

Fractional Products

프랙셔널 제품

V4 BALL ENDMILLS

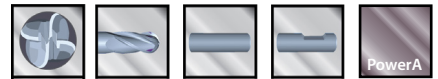

V4 볼 엔드밀

4 Flutes	Coated with or without flat
4 플루트	플랫 포함 또는 플랫 없이 코팅

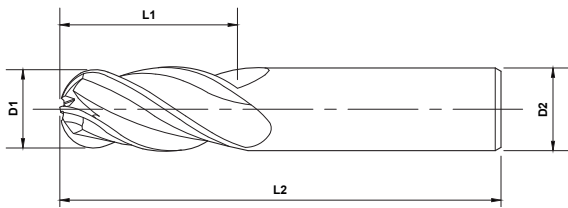

PowerA

Standard, Series 400

Length Key (K)

Stub Standard Long

Quick Ship Items



	OD	LOC	SHK	OAL	PowerA	
					No Flat	With Flat
	D1	L2	D2	L2		
	1/4	5/8	1/4	2-1/2	400-210-1	-
	5/16	13/16	5/16	2-1/2	400-212-1	-
	3/8	7/8	3/8	2-1/2	400-216-1	400-216W-1
	1/2	1	1/2	3	400-222-1	400-222W-1
	5/8	1-1/4	5/8	3-1/2	400-228-1	400-228W-1
	3/4	1-1/2	3/4	4	400-230-1	400-230W-1
	1	1-1/2	1	4	400-234-1	400-234W-1

Fractional Products
프랙셔널 제품

V4 CORNER RADIUS ENDMILLS

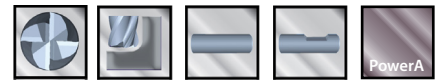

V4 코너 반경 엔드밀

4 Flutes	Coated with or without flat
4 플루트	플랫 포함 또는 플랫 없이 코팅

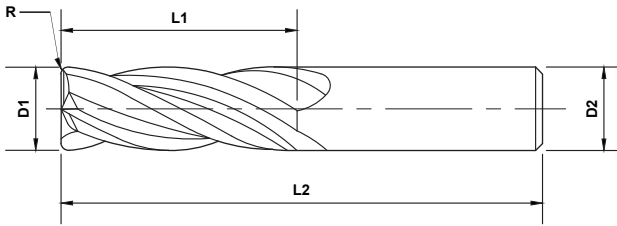

PowerA

Standard, Series 400

Length Key (K)

Stub Standard Long

Quick Ship Items



	OD	LOC	SHK	OAL	Radius	PowerA	
	D1	L1	D2	L2	R	No Flat	With Flat
1/4	5/8	5/8	1/4	2-1/2	.015	400-421-1	-
			1/4	2-1/2	.020	400-422-1	-
5/16	13/16	13/16	5/16	2-1/2	.015	400-431-1	-
			5/16	2-1/2	.020	400-432-1	-
3/8	7/8	7/8	3/8	2-1/2	.020	400-442-1	400-442W-1
			3/8	2-1/2	.030	400-443-1	400-443W-1
1/2	1	1	1/2	3	.020	400-462-1	400-462W-1
			1/2	3	.030	400-463-1	400-463W-1
5/8	1-1/4	1-1/4	5/8	3-1/2	.020	400-492-1	400-492W-1
			5/8	3-1/2	.030	400-493-1	400-493W-1
3/4	1-1/2	1-1/2	3/4	4	.030	400-503-1	400-503W-1
			3/4	4	.045	400-504-1	400-504W-1

Fractional Products
프랙셔널 제품

V5 SQUARE ENDMILLS

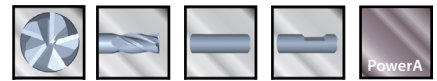

V5 스퀘어 엔드밀

5 Flutes	Coated with or without flat
5 플루트	플랫 포함 또는 플랫 없이 코팅

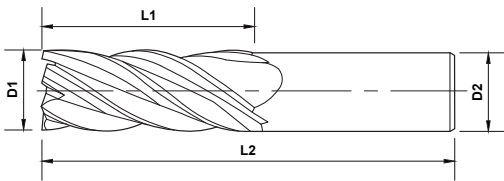

IMPERIAL PRODUCTS



PowerA

Standard, Series 408

Length Key (K)

■ Stub
 ■ Standard
 ■ Long



	OD	LOC	SHK	OAL	PowerA	
					No Flat	With Flat
	D1	L1	D2	L2		
Standard, Series 408	3/8	7/8	3/8	2-1/2	408-010-1	408-010W-1
	1/2	1	1/2	3	408-014-1	408-014W-1
	5/8	1-1/4	5/8	3-1/2	408-020-1	408-020W-1
	3/4	1-1/2	3/4	4	408-024-1	408-024W-1
	1	1-1/2	1	4	408-026-1	408-026W-1

Fractional Products

프랙셔널 제품

Email: sales@mastercuttool.com
www.mastercuttool.com



V5 BALL ENDMILLS

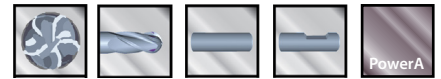

V5 볼 엔드밀

5 Flutes	Coated with or without flat
5 플루트	플랫 포함 또는 플랫 없이 코팅

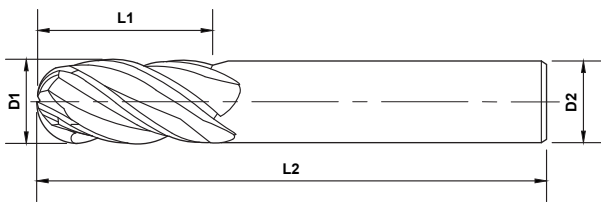

PowerA

Length Key (K)

■ Stub
 ■ Standard
 ■ Long



	OD	LOC	SHK	OAL	PowerA	
	D1	L1	D2	L2	No Flat	With Flat
K	3/8	7/8	3/8	2-1/2	408-210-1	408-210W-1
	1/2	1	1/2	3	408-214-1	408-214W-1
	5/8	1-1/4	5/8	3-1/2	408-220-1	408-220W-1
	3/4	1-1/2	3/4	4	408-222-1	408-222W-1
	1	1-1/2	1	4	408-226-1	408-226W-1

Fractional Products
 프랙셔널 제품

V5 CORNER RADIUS ENDMILLS

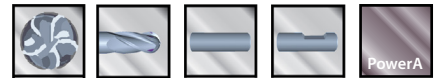

V5 코너 반경 엔드밀

5 Flutes	Coated with or without flat
5 플루트	플랫 포함 또는 플랫 없이 코팅

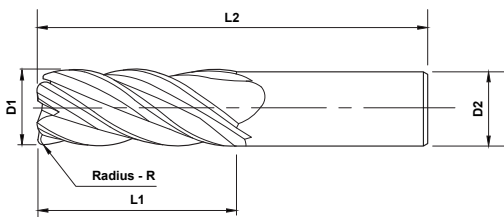

PowerA

Standard, Series 408

Length Key (K)

■ Stub
 ■ Standard
 ■ Long



	OD	LOC	SHK	OAL	Radius	PowerA	
	D1	L1	D2	L2	R	No Flat	With Flat
3/8		7/8	3/8	2-1/2	.015	408-441-1	408-441W-1
		7/8	3/8	2-1/2	.020	408-442-1	408-442W-1
1/2		1	1/2	3	.020	408-462-1	408-462W-1
		1	1/2	3	.030	408-463-1	408-463W-1
5/8		1-1/4	5/8	3-1/2	.020	408-492-1	408-492W-1
		1-1/4	5/8	3-1/2	.030	408-493-1	408-493W-1
3/4		1-1/2	3/4	4	.030	408-503-1	408-503W-1
		1-1/2	3/4	4	.045	408-504-1	408-504W-1
1		1-1/2	1	4	.030	408-523-1	408-523W-1
		1-1/2	1	4	.045	408-524-1	408-524W-1

Fractional Products
프랙셔널 제품

F45 6 FLUTE SQUARE ENDMILLS

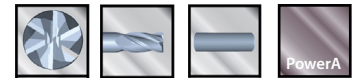

F45 6 플루트 스퀘어 엔드밀

6 Flutes	Coated and Uncoated
6 플루트	코팅 및 비코팅

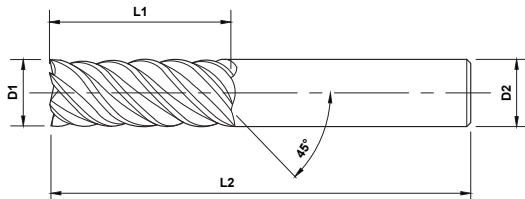

Uncoated

Standard, Series 411



PowerA

Standard, Series 411

Length Key (K)

■ Stub
 ■ Standard
 ■ Long



	OD	LOC	SHK	OAL	Uncoated	PowerA
	D1	L1	D2	L2	Part ID	Part ID
	3/8	1	3/8	2-1/2	411-008	411-008-1
	1/2	1	1/2	3	411-012	411-012-1
	5/8	1-1/4	5/8	3-1/2	411-016	411-016-1
	3/4	1-1/2	3/4	4	411-018	411-018-1
	1	1-1/2	1	4	411-022	411-022-1

Fractional Products

프랙셔널 제품

F45 6 FL CORNER RADIUS ENDMILLS



F45 6 FL 코너 반경 엔드밀

6 Flutes	Coated and Uncoated
6 플루트	코팅 및 비코팅

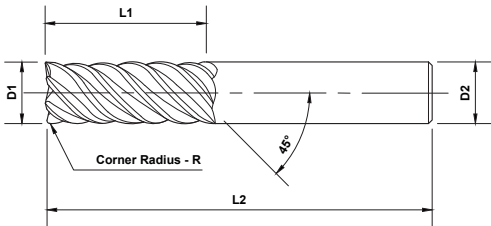

Uncoated

Standard, Series 411



PowerA

Standard, Series 411

Length Key (K)

■ Stub
 ■ Standard
 ■ Long



	OD	LOC	SHK	OAL	Radius	Uncoated	PowerA
	D1	L1	D2	L2	R	Part ID	Part ID
	3/8	1	3/8	2-1/2	.012	411-220	411-220-1
	1/2	1	1/2	3	.015	411-241	411-241-1
	5/8	1-1/4	5/8	3-1/2	.020	411-262	411-262-1
	3/4	1-1/2	3/4	4	.030	411-273	411-273-1
	1	1-1/2	1	4	.030	411-293	411-293-1

Fractional Products
프랙셔널 제품

SQUARE END AXMILLS

스퀘어 엔드 악스밀

2 and 3 Flutes	Coated and Uncoated
2 및 3 플루트	코팅 및 비코팅

Non-Ferrous
N

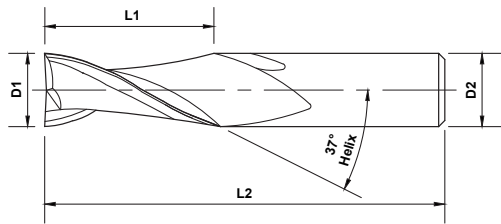

Uncoated

Standard, Series 411



PowerZ

Standard, Series 411

Length Key (K)

Stub
 Standard
 Long

Quick Ship Items



OD	LOC	SHK	OAL	Uncoated	PowerZ	Uncoated	PowerZ
D1	L1	D2	L2	2 Flute	2 Flute	3 Flute	3 Flute
1/4	3/4	1/4	2-1/2	414-008	414-008-4	420-008	420-008-4
	1	1/4	2-1/2	414-010	414-010-4	420-010	420-010-4
	1-1/8	1/4	2-1/2	-	-	421-082	421-082-4
3/8	7/8	3/8	2-1/2	414-016	414-016-4	420-016	420-016-4
	1	3/8	2-1/2	414-018	414-018-4	420-018	420-018-4
1/2	1	1/2	3	414-022	414-022-4	420-022	420-022-4
	1-1/4	1/2	3	414-024	414-024-4	420-024	420-024-4
5/8	1-1/4	5/8	3-1/2	414-028	414-028-4	420-028	420-028-4
	1-1/2	3/4	4	414-032	414-032-4	420-032	420-032-4
3/4	1-3/4	3/4	4	414-034	414-034-4	420-034	420-034-4
	1-1/4	1	5	-	-	421-164	421-164-4
1	1-1/2	1	5	-	-	421-166	421-166-4

Fractional Products

프랙셔널 제품

JOBBER DRILLS

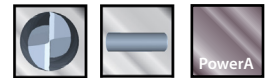

자버 드릴

2 Flute	118° Four Facet Point	Coated and Uncoated
2 플루트	118° 4 패시트 포인트	코팅 및 비코팅

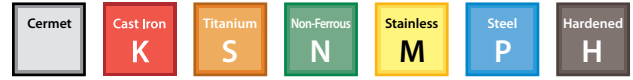
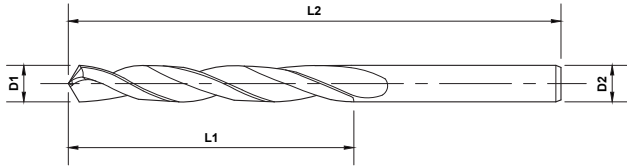

Uncoated

Length Key (K)

■ Stub
 ■ Standard
 ■ Long



OD	LOC	SHK	OAL	Wire	Uncoated	PowerA
D1	L1	D2	L2	Letter	Part ID	Part ID
1/8	1-1/4	1/8	2-1/4		601-104	601-104-1
.1285	1-3/8	.1285	2-1/2	30	601-106	601-106-1
.1360	1-3/8	.1360	2-1/2	29	601-108	601-108-1
.1378	1-3/8	.1378	2-1/2		601-110	601-110-1
.1405	1-3/8	.1405	2-1/2	28	601-112	601-112-1
9/64	1-3/8	9/64	2-1/2		601-114	601-114-1
.1440	1-3/8	.1440	2-1/2	27	601-116	601-116-1
.1470	1-3/8	.1470	2-1/2	26	601-118	601-118-1
.1495	1-3/8	.1495	2-1/2	25	601-120	601-120-1
.1520	1-3/8	.1520	2-1/2	24	601-122	601-122-1
.1540	1-3/8	.1540	2-1/2	23	601-124	601-124-1
5/32	1-3/8	5/32	2-1/2		601-126	601-126-1
.1570	1-3/8	.1570	2-1/2	22	601-128	601-128-1
.1575	1-3/8	.1575	2-1/2		601-130	601-130-1
.1590	1-3/8	.1590	2-1/2	21	601-132	601-132-1
.1610	1-3/8	.1610	2-1/2	20	601-134	601-134-1
.1660	1-5/8	.1660	2-3/4	19	601-136	601-136-1
.1695	1-5/8	.1695	2-3/4	18	601-138	601-138-1
11/64	1-5/8	11/64	2-3/4		601-140	601-140-1
.1730	1-5/8	.1730	2-3/4	17	601-142	601-142-1
.1770	1-5/8	.1770	2-3/4	16	601-144	601-144-1
.1772	1-5/8	.1772	2-3/4		601-146	601-146-1

Fractional Products
프랙셔널 제품

JOBBER DRILLS

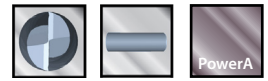

자버 드릴



OD	LOC	SHK	OAL	Wire	Uncoated	PowerA
D1	L1	D2	L2	Letter	Part ID	Part ID
.1800	1-5/8	.1800	2-3/4	15	601-148	601-148-1
.1820	1-5/8	.1820	2-3/4	14	601-150	601-150-1
.1850	1-5/8	.1850	2-3/4	13	601-152	601-152-1
3/16	1-5/8	3/16	2-3/4		601-154	601-154-1
.1890	1-5/8	.1890	2-3/4	12	601-156	601-156-1
.1910	1-5/8	.1910	2-3/4	11	601-158	601-158-1
.1935	1-5/8	.1935	2-3/4	10	601-160	601-160-1
.1960	1-3/4	.1960	3	9	601-162	601-162-1
.1968	1-3/4	.1968	3		601-164	601-164-1
.1990	1-3/4	.1990	3	8	601-166	601-166-1
.2010	1-3/4	.2010	3	7	601-168	601-168-1
13/64	1-3/4	13/64	3		601-170	601-170-1
.2040	1-3/4	.2040	3	6	601-172	601-172-1
.2055	1-3/4	.2055	3	5	601-174	601-174-1
.2090	1-3/4	.2090	3	4	601-176	601-176-1
.2130	1-3/4	.2130	3	3	601-178	601-178-1
.2165	1-3/4	.2165	3		601-180	601-180-1
7/32	1-3/4	7/32	3		601-182	601-182-1
.2210	1-3/4	.2210	3	2	601-184	601-184-1
.2280	1-3/4	.2280	3	1	601-186	601-186-1
.2340	2	.2340	3-1/4	A	601-188	601-188-1
15/64	2	15/64	3-1/4		601-190	601-190-1
.2362	2	.2362	3-1/4		601-192	601-192-1
.2380	2	.2380	3-1/4	B	601-194	601-194-1
.2420	2	.2420	3-1/4	C	601-196	601-196-1
.2460	2	.2460	3-1/4	D	601-198	601-198-1
1/4	2	1/4	3-1/4	E	601-200	601-200-1
.2559	2	.2559	3-1/4		601-202	601-202-1
.2570	2	.2570	3-1/4	F	601-204	601-204-1
.2610	2-1/8	.2610	3-1/2	G	601-206	601-206-1
17/64	2-1/8	17/64	3-1/2		601-208	601-208-1
.2660	2-1/8	.2660	3-1/2	H	601-210	601-210-1
.2720	2-1/8	.2720	3-1/2	I	601-212	601-212-1
.2756	2-1/8	.2756	3-1/2		601-214	601-214-1
.2770	2-1/8	.2770	3-1/2	J	601-216	601-216-1
.2810	2-1/8	.2810	3-1/2	K	601-218	601-218-1
9/32	2-1/8	9/32	3-1/2		601-220	601-220-1
.2900	2-1/8	.2900	3-1/2	L	601-222	601-222-1

Fractional Products
프랙셔널 제품

JOBBER DRILLS

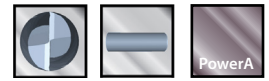

자버 드릴



OD	LOC	SHK	OAL	Wire	Uncoated	PowerA
D1	L1	D2	L2	Letter	Part ID	Part ID
.2950	2-3/8	.2950	4	M	601-224	601-224-1
.2953	2-3/8	.2953	4		601-226	601-226-1
19/64	2-3/8	19/64	4		601-228	601-228-1
.3020	2-3/8	.3020	4	N	601-230	601-230-1
5/16	2-3/8	5/16	4		601-232	601-232-1
.3150	2-3/8	.3150	4		601-234	601-234-1
.3160	2-3/8	.3160	4	O	601-236	601-236-1
.3230	2-3/8	.3230	4	P	601-238	601-238-1
21/64	2-3/8	21/64	4		601-240	601-240-1
.3320	2-3/8	.3320	4	Q	601-242	601-242-1
.3346	2-3/8	.3346	4		601-244	601-244-1
.3390	2-3/8	.3390	4	R	601-246	601-246-1
11/32	2-3/8	11/32	4		601-248	601-248-1
.3480	2-3/8	.3480	4	S	601-250	601-250-1
.3543	2-3/4	.3543	4-1/4		601-252	601-252-1
.3580	2-3/4	.3580	4-1/4	T	601-254	601-254-1
23/64	2-3/4	23/64	4-1/4		601-256	601-256-1
.3680	2-3/4	.3680	4-1/4	U	601-258	601-258-1
.3740	2-3/4	.3740	4-1/4		601-260	601-260-1
3/8	2-3/4	3/8	4-1/4		601-262	601-262-1
.3770	2-3/4	.3770	4-1/4	V	601-264	601-264-1
.3860	2-7/8	.3860	4-1/2	W	601-266	601-266-1
25/64	2-7/8	25/64	4-1/2		601-268	601-268-1
.3937	2-7/8	.3937	4-1/2		601-270	601-270-1
.3970	2-7/8	.3970	4-1/2	X	601-272	601-272-1
.4040	2-7/8	.4040	4-1/2	Y	601-274	601-274-1
13/32	2-7/8	13/32	4-1/2		601-276	601-276-1
.4130	2-7/8	.4130	4-1/2	Z	601-278	601-278-1
.4134	2-7/8	.4134	4-1/2		601-280	601-280-1
27/64	2-7/8	27/64	4-1/2		601-282	601-282-1
.4331	2-7/8	.4331	4-1/2		601-284	601-284-1
7/16	2-7/8	7/16	4-1/2		601-286	601-286-1
.4527	3	.4527	4-3/4		601-288	601-288-1
29/64	3	29/64	4-3/4		601-290	601-290-1
15/32	3	15/32	4-3/4		601-292	601-292-1
.4724	3	.4724	4-3/4		601-294	601-294-1
31/64	3	31/64	4-3/4		601-296	601-296-1
.4921	3	.4921	4-3/4		601-298	601-298-1
1/2	3	1/2	4-3/4		601-300	601-300-1

IMPERIAL PRODUCTS

Fractional Products
프랙셔널 제품

SPADE DRILLS

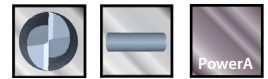

스페이드 드릴

2 Flutes	118° Point	Coated and Uncoated
2 플루트	118° 포인트	코팅 및 비코팅

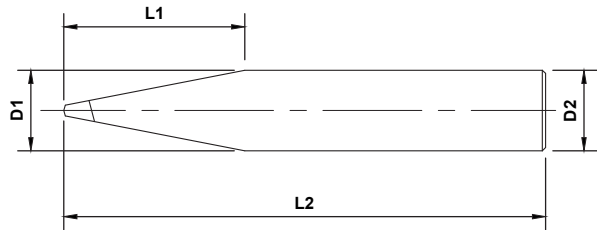
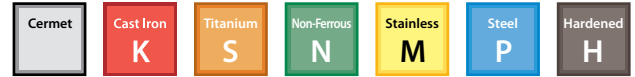

Uncoated

Length Key (K)

Stub
 Standard
 Long



	OD	LOC	SHK	OAL	Uncoated	PowerA
	D1	L1	D2	L2	Part ID	Part ID
	1/32	3/16	1/32	1-1/2	600-002	600-002-1
	1/16	5/16	1/16	1-1/2	600-004	600-004-1
	3/32	3/8	3/32	1-1/2	600-006	600-006-1
	1/8	7/16	1/8	1-1/2	600-008	600-008-1
	5/32	15/32	5/32	2	600-010	600-010-1
	3/16	9/16	3/16	2	600-012	600-012-1
	7/32	19/32	7/32	2	600-014	600-014-1
	1/4	11/16	1/4	2	600-016	600-016-1
	9/32	3/4	9/32	2-1/2	600-018	600-018-1
	5/16	7/8	5/16	2-1/2	600-020	600-020-1
	3/8	1	3/8	2-1/2	600-022	600-022-1
	7/16	1-1/4	7/16	2-1/2	600-024	600-024-1
1/2	1-3/8	1/2	2-1/2	600-026	600-026-1	

Fractional Products

프랙셔널 제품

NC SPOTTING DRILLS

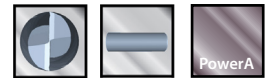

NC 스포팅 드릴

2 Flutes	90°, 120° and 142°	Coated and Uncoated
2 플루트	90°, 120° 및 142°	코팅 및 비코팅

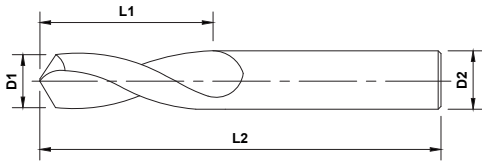

Uncoated

Length Key (K)

■ Stub
 ■ Standard
 ■ Long



OD	LOC	SHK	OAL	Uncoated			PowerA		
				90°	120°	142°	90°	120°	142°
D1	L1	D2	L2	90°	120°	142°	90°	120°	142°
1/8	3/8	1/8	2	600-402	600-502	600-602	600-402-1	600-502-1	600-602-1
3/16	3/4	3/16	3	600-404	600-504	600-604	600-404-1	600-504-1	600-604-1
1/4	3/4	1/4	3	600-406	600-506	600-606	600-406-1	600-506-1	600-606-1
5/16	1	5/16	2-1/2	600-408	600-508	600-608	600-408-1	600-508-1	600-608-1
3/8	1	3/8	3	600-410	600-510	600-610	600-410-1	600-510-1	600-610-1
1/2	1	1/2	4	600-412	600-512	600-612	600-412-1	600-512-1	600-612-1

Fractional Products
프랙셔널 제품

DRILL AND COUNTERSINK

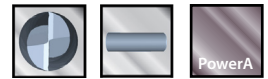

드릴 및 카운터싱크

2 Flutes	118° Point	Coated and Uncoated
2 플루트	118° 포인트	코팅 및 비코팅

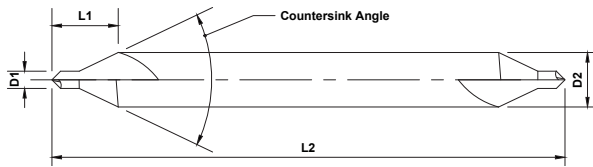
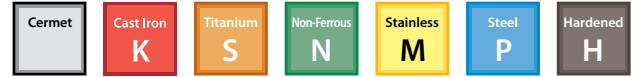

Uncoated

Length Key (K)

■ Stub
 ■ Standard
 ■ Long



	OD	LOC	SHK	OAL	Uncoated			PowerA		
					60°	82°	90°	60°	82°	90°
	D1	L1	D2	L2						
K	3/64	3/64	1/8	1-1/2	600-304	600-104	600-204	600-304-1	600-104-1	600-204-1
	5/64	5/64	3/16	2	600-306	600-106	600-206	600-306-1	600-106-1	600-206-1
	7/64	7/64	1/4	2	600-308	600-108	600-208	600-308-1	600-108-1	600-208-1
	1/8	1/8	5/16	2-1/8	600-310	600-110	600-210	600-310-1	600-110-1	600-210-1
	3/16	3/16	7/16	2-3/4	600-312	600-112	600-212	600-312-1	600-112-1	600-212-1
	7/32	7/32	1/2	3	600-314	600-114	600-214	600-314-1	600-114-1	600-214-1
	1/4	1/4	5/8	3-1/8	600-316	600-116	600-216	600-316-1	600-116-1	600-216-1
	5/16	5/16	3/4	3-3/8	600-318	600-118	600-218	600-318-1	600-118-1	600-218-1

Fractional Products

프랙셔널 제품

SA BURS - CYLINDRICAL SHAPE WITHOUT END CUT

SA 버 - 엔드 컷 없는 원통형

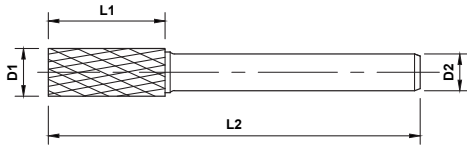

Non-Ferrous **N** Alumacuts recommended for non-ferrous materials

Cast Iron **K** Titanium **S** Stainless **M** Steel **P** Hardened **H**

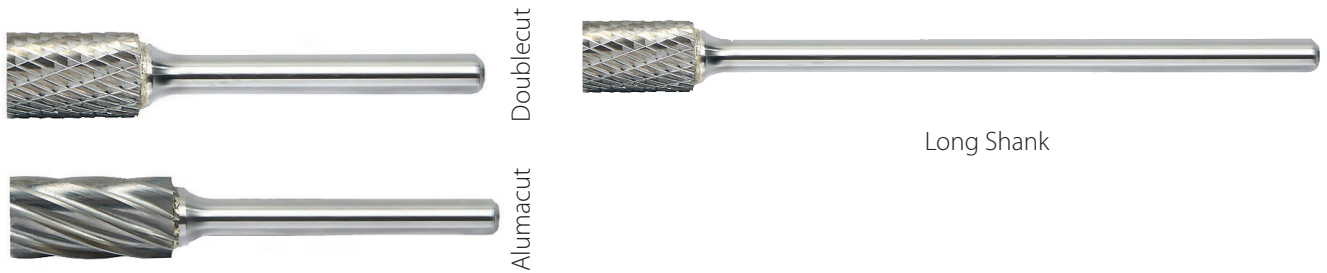

Length Key (K)

■ Stub
 ■ Standard
 ■ Long

Quick Ship Items

	OD	LOC	SHK	OAL	Cut Type	
	D1	L1	D2	L2	Doublecut	Alumacut
*	1/8	9/16	1/8	1-1/2	SA-43DC	-
*	1/4	5/8	1/4	2	SA-1DC	SA-1FM
	3/8	3/4	1/4	2-1/2	SA-3DC	SA-3FM
		3/4	1/4	6-3/4	SA-3L6DC	SA-3L6FM
	1/2	1	1/4	2-3/4	SA-5DC	SA-5FM
		1	1/4	7	SA-5L6DC	SA-5L6FM

* Solid Carbide • *솔리드 카바이드

Fractional Products
프랙셔널 제품

SB BURS - CYLINDRICAL SHAPE WITH END CUT

SB 버 - 엔드 컷 있는 원통형

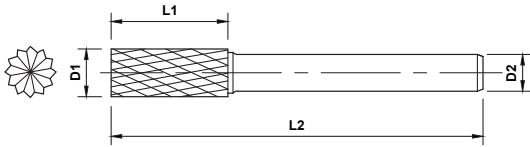

Non-Ferrous **N** Alumacuts recommended for non-ferrous materials

Cast Iron **K** Titanium **S** Stainless **M** Steel **P** Hardened **H**

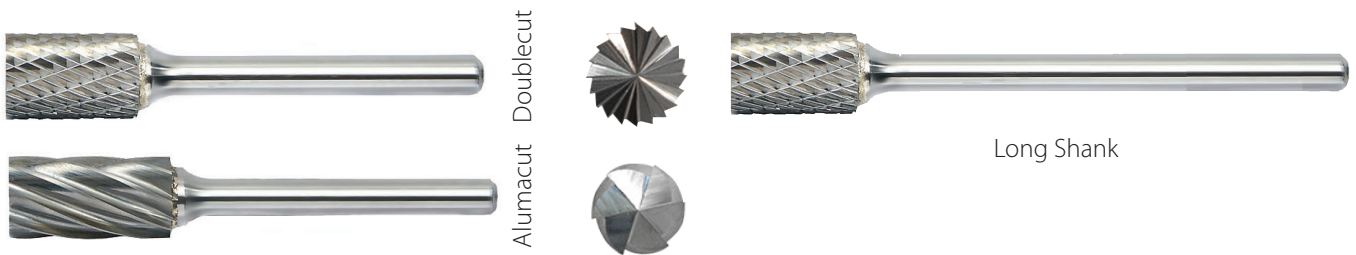

Length Key (K)

Standard Long * Solid Carbide

Quick Ship Items

	OD	LOC	SHK	OAL	Cut Type	
	D1	L1	D2	L2	Doublecut	Alumacut
* *	1/8	9/16	1/8	1-1/2	SB-43DC	-
	1/4	5/8	1/4	2	SB-1DC	SB-1FM
	3/8	3/4	1/4	2-1/2	SB-3DC	SB-3FM
		3/4	1/4	6-3/4	SB-3L6DC	SB-3L6FM
	1/2	1	1/4	2-3/4	SB-5DC	SB-5FM
		1	1/4	7	SB-5L6DC	SB-5L6FM

* Solid Carbide • *솔리드 카바이드

Fractional Products
프랙셔널 제품

SC BURS - RADIUS CYLINDRICAL SHAPE

SC 버 - 반경 원통형

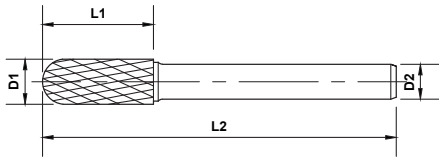

Non-Ferrous **N** Almacuts recommended for non-ferrous materials

Cast Iron **K** Titanium **S** Stainless **M** Steel **P** Hardened **H**



Length Key (K)

Standard Long * Solid Carbide

Quick Ship Items

	OD	LOC	SHK	OAL	Cut Type	
	D1	L1	D2	L2	Doublecut	Alamacut
*	1/8	9/16	1/8	1-1/2	SC-42DC	-
*	1/4	5/8	1/4	2	SC-1DC	SC1-FM
	3/8	3/4	1/4	2-1/2	SC-3DC	SC-3FM
		3/4	1/4	6-3/4	SC-3L6DC	SC-3L6FM
	1/2	1	1/4	2-3/4	SC-5DC	SC-5FM
		1	1/4	7	SC-5L6DC	SC-5L6FM

* Solid Carbide • *솔리드 카바이드

Fractional Products
프랙셔널 제품

Email: sales@mastercuttool.com
www.mastercuttool.com



SD BURS - BALL SHAPE

SD 버 - 볼형

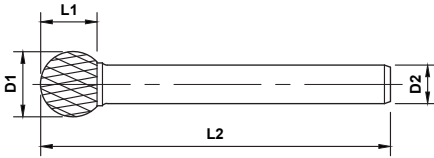

Non-Ferrous **N** Alumacut recommended for non-ferrous materials

Cast Iron **K** Titanium **S** Stainless **M** Steel **P** Hardened **H**

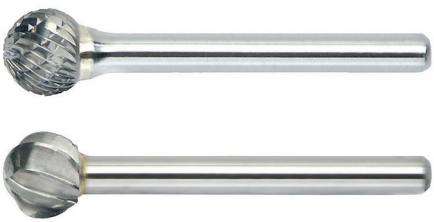

Alumacut Doublecut



Long Shank

Length Key (K)

Standard Long * Solid Carbide

Quick Ship Items

	OD	LOC	SHK	OAL	Cut Type	
	D1	L1	D2	L2	Doublecut	Alumacut
*	1/8	1/8	1/8	1-1/2	SD-42DC	-
*	1/4	7/32	1/4	2	SD-1DC	SD-1FM
	3/8	5/16	1/4	2-1/8	SD-3DC	SD-3FM
		5/16	1/4	6-3/8	SD-3L6DC	SD-3L6FM
	1/2	7/16	1/4	2-1/4	SD-5DC	SD-5FM
		7/16	1/4	6-1/2	SD-5L6DC	SD-5FM

* Solid Carbide • *솔리드 카바이드

Fractional Products
프랙셔널 제품

SE BURS - OVAL SHAPE

SE 버 - 타원형

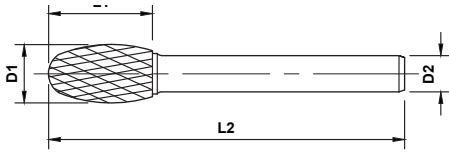

Non-Ferrous **N** Almacuts recommended for non-ferrous materials

Cast Iron K	Titanium S	Stainless M	Steel P	Hardened H
--------------------	-------------------	--------------------	----------------	-------------------

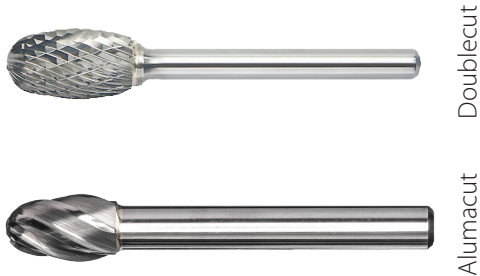

Length Key (K)

Standard Long * Solid Carbide

Quick Ship Items

	OD	LOC	SHK	OAL	Cut Type	
	D1	L1	D2	L2	Doublecut	Alumacut
*	1/8	7/32	1/8	1-1/2	SE-41DC	-
*	1/4	3/8	1/4	2	SE-1DC	SE-1FM
	3/8	5/8	1/4	2-3/8	SE-3DC	SE-3FM
		5/8	1/4	6-5/8	SE-3L6DC	SE-3L6FM
	1/2	7/8	1/4	2-5/8	SE-5DC	SE-5FM
		7/8	1/4	6-7/8	SE-5L6DC	SE-5L6FM

* Solid Carbide • *솔리드 카바이드

Fractional Products
프랙셔널 제품

Email: sales@mastercuttool.com
www.mastercuttool.com



SF BURS - RADIUS TREE SHAPE

SF 버 - 반경 트리형

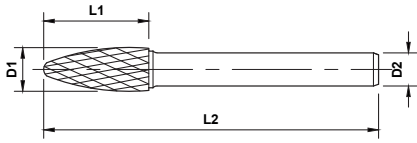

Non-Ferrous **N** Alumacuts recommended for non-ferrous materials

Cast Iron **K** Titanium **S** Stainless **M** Steel **P** Hardened **H**



Length Key (K)

Standard Long * Solid Carbide

Quick Ship Items

	OD	LOC	SHK	OAL	Cut Type	
	D1	L1	D2	L2	Doublecut	Alumacut
*	1/8	1/2	1/8	1-1/2	SF-42DC	-
*	1/4	5/8	1/4	2	SF-1DC	SF-1FM
	3/8	3/4	1/4	2-1/2	SF-3DC	SF-3FM
		3/4	1/4	6-3/4	SF-3L6DC	SF-3L6FM
	1/2	1	1/4	2-3/4	SF-5DC	SF-5FM
		1	1/4	7	SF-5L6DC	SF-5L6FM

* Solid Carbide • *슬리드 카바이드

Fractional Products
프랙셔널 제품

SG BURS - POINTED TREE SHAPE

SG 버 - 뾰족한 트리형

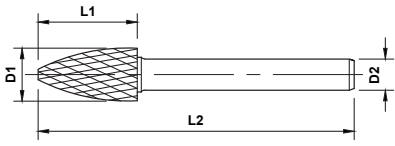

Doublecut



Long Shank

Non-Ferrous **N** Almacuts recommended for non-ferrous materials

Cast Iron **K** Titanium **S** Stainless **M** Steel **P** Hardened **H**

Length Key (K)

Standard Long * Solid Carbide

Quick Ship Items

	OD	LOC	SHK	OAL	Cut Type
	D1	L1	D2	L2	Doublecut
*	1/8	3/8	1/8	1-1/2	SG-43DC
*	1/4	5/8	1/4	2	SG-1DC
	3/8	3/4	1/4	2-1/2	SG-3DC
		3/4	1/4	6-3/4	SG-3L6DC
	1/2	1	1/4	2-3/4	SG-5DC
		1	1/4	7	SG-5L6DC

* Solid Carbide • *솔리드 카바이드

SH BURS - FLAME SHAPE

SH 버 - 불꽃형

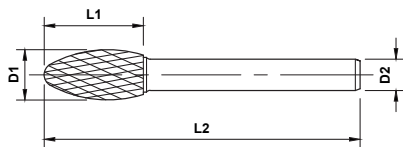

Doublecut

Non-Ferrous **N** Almacuts recommended for non-ferrous materials

Cast Iron **K** Titanium **S** Stainless **M** Steel **P** Hardened **H**

Length Key (K)

Standard Long * Solid Carbide

Quick Ship Items

	OD	LOC	SHK	OAL	Cut Type
	D1	L1	D2	L2	Doublecut
*	1/8	1/4	1/8	1-1/2	SH-41DC
*	1/4	1/2	1/4	2	SH-1DC
	5/16	3/4	1/4	2-1/2	SH-2DC
	1/2	1-1/4	1/4	3	SH-5DC

* Solid Carbide • *솔리드 카바이드

SL BURS - RADIUS CONE SHAPE

SL 버 - 반경 원뿔형

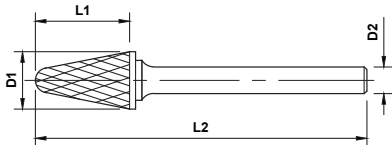

Non-Ferrous **N** Almacuts recommended for non-ferrous materials

Cast Iron **K** Titanium **S** Stainless **M** Steel **P** Hardened **H**



Length Key (K)

Standard Long * Solid Carbide

Quick Ship Items

	OD	LOC	SHK	OAL	Angle	Cut Type	
	D1	L1	D2	L2	Deg	Doublecut	Alamacut
*	1/8	3/8	1/8	1-1/2	8°	SL-41DC	-
*	1/4	5/8	1/4	2	14°	SL-1DC	SL-3FM
	3/8	1-1/16	1/4	2-13/16	14°	SL-3DC	SL-3FM
		1-1/16	1/4	7-1/16	14°	SL-3L6DC	SL-3L6FM
	1/2	1-1/8	1/4	3-1/64	14°	SL-4DC	SL-4FM
		1-1/8	1/4	7-1/8	14°	SL-4L6DC	SL-4L6FM

* Solid Carbide • *솔리드 카바이드

Fractional Products
프랙셔널 제품

SM BURS - POINTED CONE SHAPE

SM 버 - 뾰족한 원뿔형

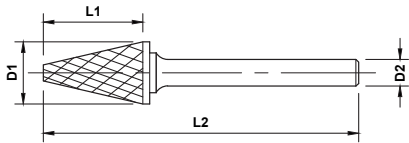

Non-Ferrous
N Almacuts recommended for non-ferrous materials

Cast Iron **K** Titanium **S** Stainless **M** Steel **P** Hardened **H**



Doublecut



Long Shank

Length Key (K)

Standard Long * Solid Carbide

Quick Ship Items

	OD	LOC	SHK	OAL	Inclusive Angle	Cut Type	
	D1	L1	D2	L2	Deg	Doublecut	Chipbreaker
*	1/8	11/32	1/8	1-1/2	12°	SM-41DC	SM-41CB
*	1/4	1/2	1/4	2	14°	SM-1DC	SM-1CB
	3/8	5/8	1/4	2-1/2	28°	SM-4DC	SM-4CB
	1/2	7/8	1/4	2-5/8	28°	SM-5DC	SM-5CB
		7/8	1/4	6-7/8	28°	SM-5L6DC	SM-5L6CB

* Solid Carbide • *솔리드 카바이드

Fractional Products
프랙셔널 제품

Email: sales@mastercuttool.com
www.mastercuttool.com



MASTERCUT PREMIER COATINGS

Mastercut 프리미어 옵션

- Speed and Feed increases from 30 to 200 percent
- Tool life is increased up to 10 times
- Reduces friction, spindle torque and vibration, providing a better finish
- Isolates the tool from the part, avoids edge buildup and tool cratering
- Reduces or eliminates coolant requirements
- Repeatable, stable performance between batches

- 속도와 피드가 30%~200% 증가
- 공구 수명 최대 10배 증가
- 마찰, 스피들 토크 및 진동 감소로 더 나은 마감 제공
- 공구를 부품에서 격리하고 에지 빌드업 및 공구 크레이터링 방지
- 쿨런트 요구사항을 줄이거나 제거
- 배치 간 반복 가능하고 안정적인 성능

MASTERCUT TOOL COATING OPTIONS

- Preferred Coating Use
- 선호 코팅 사용

									
	Materials	PowerT	PowerC	PowerA	PowerZ	PowerNR	PowerN	PowerDLC	PowerRD
1	Aluminum, Low Silicon < 10% 알루미늄, 저 실리콘 < 10%				✓			✓	✓
2	Aluminum, High Silicon > 10% 알루미늄, 고 실리콘 > 10%		✓		✓			✓	✓
3	Copper, Copper Alloys 구리, 구리 합금	✓		✓	✓			✓	
4	Ductile, Malleable Cast Iron 덕타일, 가단 주철	✓	✓	✓	✓	✓	✓		
5	Carbon Steel, 1000 Series 탄소강, 1000 시리즈	✓	✓	✓		✓	✓		
6	Alloy Steel, 4 to 9000 Series 합금강, 4 ~ 9000 시리즈	✓	✓	✓		✓	✓		
7	Tool Steel 공구강	✓	✓	✓		✓	✓		
8	SS Steel, 300 Series SS 스틸, 300 시리즈	✓	✓	✓	✓	✓	✓		
9	SS Steel, 400 Series SS 스틸, 400 시리즈	✓	✓	✓	✓	✓	✓		
10	SS PH Series SS PH 시리즈	✓	✓	✓	✓	✓	✓		
11	Titanium, Titanium Alloys 티타늄, 티타늄 합금	✓	✓	✓	✓	✓	✓		
12	Nickel, Nickel Alloys, Cobalt 니켈, 니켈 합금, 코발트	✓		✓		✓	✓		
13	Wood, Paper 목재, 종이			✓	✓			✓	
14	Composites, Plastics 합성물, 플라스틱	✓		✓	✓		✓	✓	✓
15	Graphite 흑연							✓	✓
16	Fiberglass 유리섬유		✓	✓	✓			✓	✓

MASTERCUT TOOL COATING OPTIONS

Our Available Coatings



PowerT (Titanium Nitride, TiN) (append -2)*

Color: Gold
Vickers Hardness: Approximately 2,300 Vickers
General purpose, entry level over uncoated carbide



PowerC (Titanium Carbon Nitride, TiCN) (append -3)*

Color: Ranges from slight violet to brown-gray
Vickers Hardness: Approximately 3,000 Vickers
Used on ferrous, non-ferrous and non-magnetic stainless steel
Good abrasion resistance, low heat resistance, for applications requiring low RPMs and high thrust



PowerA (Aluminum Titanium Nitride, AlTiN) (append -1)*

Color: Dark Gray
Vickers Hardness: Approximately 3,600 Vickers
Nickel Alloys, Stainless Steel, Hardened Steels, Tool Steels, Cast Iron
An excellent broad spectrum grade. May be run in dry or minimum quantity lubrication applications, where heat can be a problem. Also handles light chip loads very well



PowerZ (Zirconium Nitride, ZrN) (append -4)*

Color: Dull Gold
Vickers Hardness: Approximately 2,800 Vickers
Outstanding on aluminum, including high silica aluminum. Can also be used on cast iron, stainless steels, titanium

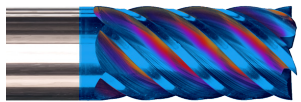

PowerN (nACo) nano-composite (nc-AlTiN)/(a-Si³N⁴) (append -5)*

Color: Varying hues of blue and red
Vickers Hardness: approximately 4,500 Vickers
Outstanding performance in superalloys, hard material machining, and high heat applications.



PowerNR (nACRo) nano-composite (nc-AlCrN/a-Si³N⁴)(append -8)*

Color: gray
Vickers Hardness: 4,000 Vickers
Outstanding in high heat applications, better resistance to shock and chipping than nACo, for tough, aggressive cutting applications.



PowerDLC (Diamond Like Carbon)(append -6)*

Color: variable gray to black
Vickers Hardness: approximately 4,000 Vickers
Non-ferrous metals, high silicone aluminum, copper, plastic, graphite, fiberglass or reinforced plastics
Can be applied to any carbide substrate



PowerRD (Real Diamond)(append -7)*

Color: variable gray to black
Vickers Hardness: approximately 8,000 Vickers
Non-ferrous, metals, aluminum, graphite, green ceramics, and composites
Requires 6% cobalt carbide for application

* **append -#** indicates that this coating is applied to uncoated tool part number

가능한 코팅

PowerT(질화 티타늄, TiN) (추가 -2)*

색상: 골드
비커스 경도: 약 2,300 비커스
범용, 비코팅 카바이드 이상의 엔트리 레벨

PowerC(티타늄 탄소 질화물, TiCN) (추가 -3)*

색상: 옅은 보라색에서 갈회색까지의 범위
비커스 경도: 약 3,000 비커스
철, 비철금속 및 비자성 스테인레스강에 사용됨
저 RPM 및 높은 추력이 요구되는 응용 분야에 적합한 내마모성, 낮은 내열성

PowerA(알루미늄 티타늄 질화물, AlTiN) (추가 -1)*

색상: 짙은 회색
비커스 경도: 약 3,600 비커스
니켈 합금, 스테인리스강, 경화강, 공구강, 주철
탁월한 브로드 스펙트럼 등급. 열이 문제가 될 수 있는 건조한 또는 최소량의 윤활 응용 분야에서 작동 가능. 가벼운 칩로드도 매우 잘 처리합니다

PowerZ(질화 지르코늄, ZrN) (추가 -4)*

색상: 무광택 골드
비커스 경도: 약 2,800 비커스
높은 실리카 알루미늄을 포함한 알루미늄에서 탁월. 주철, 스테인레스강, 티타늄에도 사용 가능

PowerN(nACo) 나노복합소재(nc-AlTiN)/(a-Si³N⁴) (추가 -5)*

색상: 파란색과 빨간색의 다양한 색조
비커스 경도: 약 4,500 비커스
초합금, 경질 재료 가공 및 고온 응용 분야에서 탁월한 성능을 발휘합니다.

PowerNR(nACRo) 나노복합소재(nc-AlCrN/a-Si³N⁴)(추가 -8)*

색상: 회색
비커스 경도: 4,000 비커스
고열 응용 분야에서 탁월한 성능, nACo보다 충격 및 치핑에 대한 우수한 내성, 거칠고 공격적인 커팅 응용 분야에 적합.

PowerDLC (다이아몬드와 유사한 탄소)(추가 -6)*

색상: 회색에서 검정색까지 다양
비커스 경도: 약 4,000 비커스
비철 금속, 높은 실리콘 알루미늄, 구리, 플라스틱, 흑연, 유리섬유 또는 강화 플라스틱
모든 카바이드 기판에 적용 가능

PowerRD(실제 다이아몬드)(추가 -7)*

색상: 회색에서 검정색까지 다양
비커스 경도: 약 8,000 비커스
비철, 금속, 알루미늄, 흑연, 그린 세라믹 및 합성물
적용시 6%의 코발트 카바이드 필요

* 추가 -#는 이 코팅이 비코팅 공구 부품 번호에 적용됨을 나타냅니다.

TECHNICAL INFORMATION

기술 정보

- ISO
- MAP
- CNC 1st
- Coatings
- Trouble Shooting Guide
- Speeds and Feeds

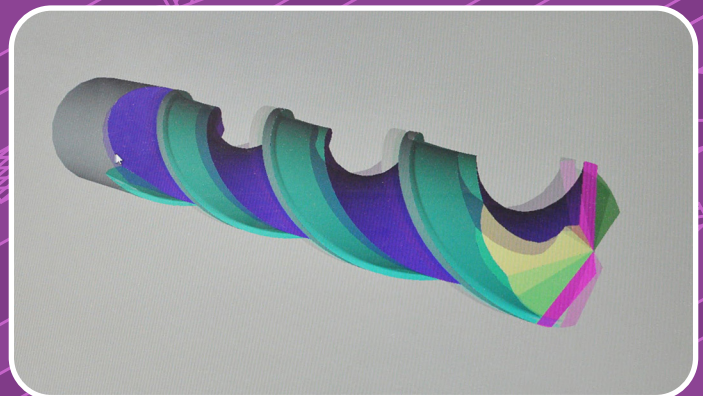
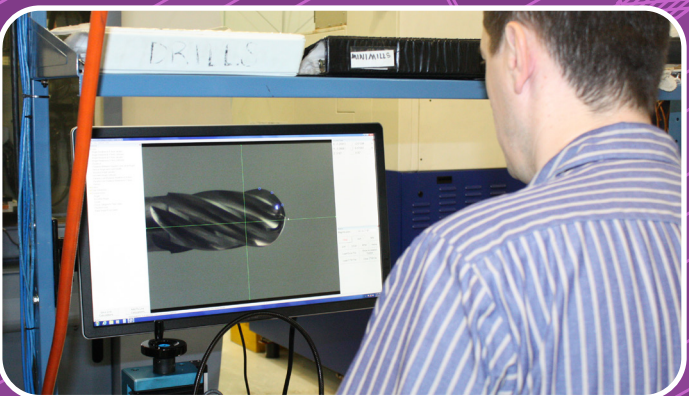
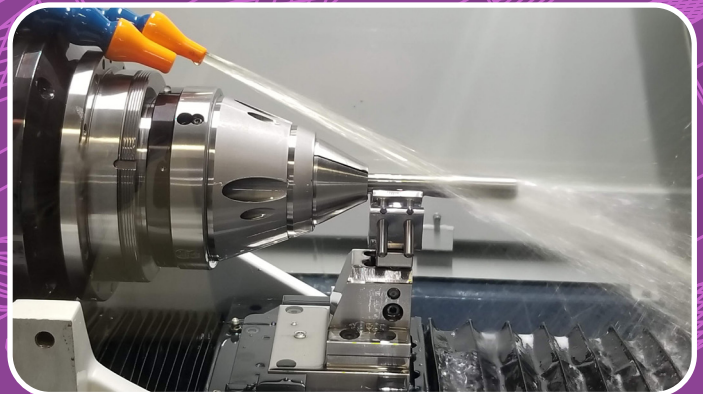
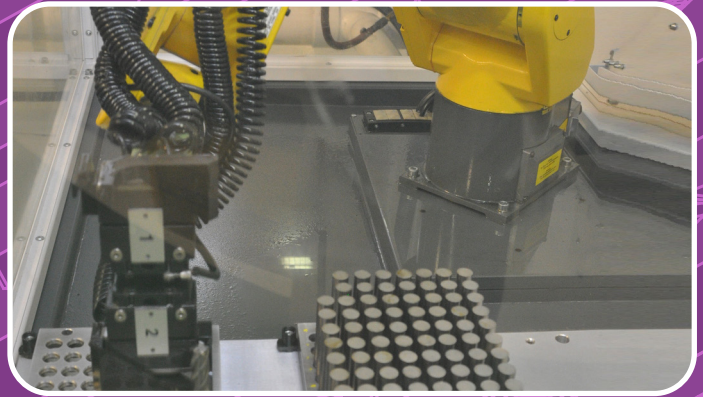
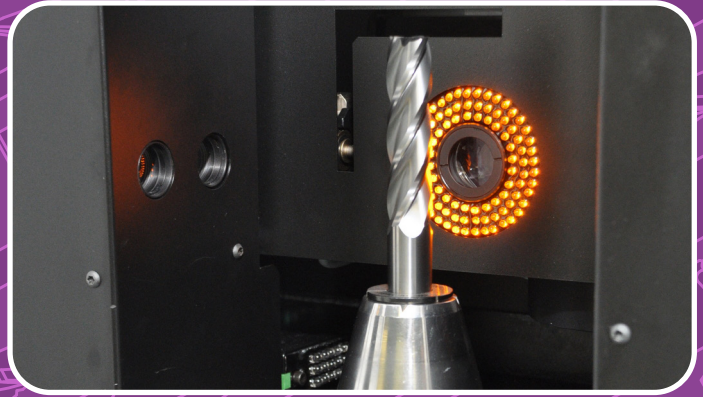



Mastercut Tool Corp.

Quality Processes

YOUR PREMIER SOURCE FOR THE HIGHEST QUALITY CUTTING TOOLS FOR MORE THAN A QUARTER CENTURY!

From 1985 to the present, the values and ideals of Mastercut Tool Corp. remain steady. We will work relentlessly to continuously improve and provide you with excellence. We are known worldwide for many unique high performance tools engineered in our Florida facilities. Our AxMill, V4, V5, and F45 are just a few products that make Mastercut Tool Corp. your choice for increasing production and reducing costs.

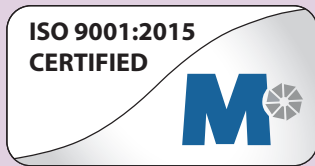

ISO 9001:2015

In 2003, Mastercut Tool Corp. successfully achieved registration under ISO 9001:2000 and has maintained our quality system to our current ISO 9001:2015 certification. We maintain these strict standards and Lean/Six Sigma practices to further guarantee that every tool you buy from Mastercut Tool Corp. is of the highest quality.

The "MAP" to Your Success!

Our continuous improvement has led us to a process that gives you unmatched, consistent quality. That process is our unique MAP Technology! Mastercut Automated Production is our exclusive method of standardization and quality repeatability. The MAP combines technology, skill, and rigid processes to provide you with the most precise products that money can buy, batch to batch and year to year.

Our MAP...your map to success!



CNC 1st Team

Customers' Needs Come First! This is what truly matters to us. To ensure you the fastest possible service, we have assembled simulation, engineering, production scheduling, customer service, and inventory personnel into one unit. They collaborate on any and all special requests from you, the moment your request is received. They are dedicated and qualified to assist you with solutions, fast!

Mastercut's Superior Carbide Blend – A-Gr-SiV (Active Grain Sized Volume)

Our superior tungsten carbide gives you the ability to be aggressive when you need to be. Growth inhibitors in our submicron carbide blanks maintain the most consistent grain size available, giving you superior hardness AND toughness.

SUCCESS

At Mastercut Tool, we take great pride in our high quality control standards and in the accomplishments of your customers using our superior quality tools. Therefore, our bottom line is:

Your customers' success with our products is the measure of our success!



품질 프로세스

25년 이상 최고 품질의 절삭 공구를 제조해 온 최고의 업체!

1985년부터 현재까지 Mastercut Tool Corp.의 가치와 이상을 꾸준히 유지해 왔습니다. 우리는 탁월한 성능을 제공하고 개선하기 위해 끊임없이 노력할 것입니다. 당사는 플로리다의 시설에서 제작된 많은 고유한 고성능 공구로 전 세계적으로 명성을 떨치고 있습니다. 당사의 AxMill, V4, V5 및 F45는 귀하의 생산량을 늘리고 비용을 절감할 수 있도록 Mastercut Tool Corp.이 제공하는 일부 제품에 불과합니다.



ISO 9001:2015

Mastercut Tool Corp.은 2003년에 ISO 9001:2000 인증을 취득했으며 현재 ISO 9001:2015 인증을 획득한 품질 시스템을 유지하고 있습니다. 우리는 귀하가 Mastercut Tool Corp.에서 구입하는 모든 공구가 최고 품질임을 보장하기 위해 이러한 엄격한 기준과 린/식스 시그마 관행을 유지합니다.

귀하의 성공을 위한 “지도(MAP)”!

지속적인 개선으로 타의 추종을 불허하고 일관된 품질을 제공하는 프로세스를 갖추게 되었습니다. 그 프로세스는 당사의 고유한 MAP 기술입니다! Mastercut 자동 생산(MAP)은 표준화 및 일관된 품질을 보장하는 당사의 독점적인 기술입니다. MAP는 기술, 재능 및 엄격한 프로세스를 결합하여 돈으로 구입할 수 있는 가장 정밀한 제품을 해마다 일괄처리 방식으로 제공합니다.



당사의 MAP는...귀하의 성공을 위한 지도입니다!



CNC 1st 팀

고객의 니즈를 최우선으로! 이는 우리에게 정말로 중요한 목표입니다. 가능한 가장 빠른 서비스를 보장하기 위해 시뮬레이션, 엔지니어링, 생산 일정 및 인벤토리 인력을 하나의 단위로 구성했으며, 따라서 어떠한 특별한 요청이든 귀하의 요청이 접수되는 즉시 협력할 수 있습니다. 이들은 자격을 갖춘 전담 인력으로, 신속하게 해결책을 제시할 것입니다!

Mastercut의 탁월한 카바이드 혼합 – A-Gr-SiV(액티브 결정 입도 불륨)

당사의 우수한 텅스텐 카바이드는 귀하가 필요할 때 공격적으로 대응할 수 있는 능력을 제공합니다. 당사의 서브 마이크론 카바이드 블랭크의 성장 억제제는 가장 균일한 결정 입도를 유지하며, 탁월한 경도와 인성을 제공합니다.

성공 Mastercut Tool Corp.은 고품질의 제어 표준과 귀하의 고객이 당사의 우수한 품질의 공구를 사용하여 달성하는 성취에 큰 자부심을 가지고 있습니다. 그에 따른 당사의 최종 목표는:

우리의 제품을 사용하는 고객의 성공은 우리의 성공의 척도입니다!

TECHNICAL INFORMATION FOR AXMILLS

악스밀 기술 정보 • 제안 축/레이디얼 하중

• Work Material • 작업 소재	Type of Cut	Axial DOC	Radial DOC	Flutes
• Aluminum Alloys 2024, 6061, 7075 • 알루미늄 합금 2024, 6061, 7075	1	1xD	1xD	2
	2	1xD	.75xD	3
	3	1.5xD	.01xD	3
• High Silicon Aluminum A380, A390 • 높은 실리콘 알루미늄 A380, A390	1	.5xD	1xD	3
	2	1xD	.5xD	3
	3	1.5xD	.01xD	3
• Magnesium Alloys • 마그네슘 합금	1	1xD	1xD	2
	2	1xD	.75xD	3
	3	1.5xD	.01xD	3
• Copper Alloys, Brass, Bronze • 구리 합금, 황동, 청동	1	.75xD	1xD	2
	2	1xD	.75xD	3
	3	1.5xD	.01xD	3
• Composites Plastics and Fiberglass • 합성 플라스틱 및 유리섬유	1	1xD	1xD	3
	2	1xD	.75xD	3
	3	1.5xD	.01xD	3

Type of Cut		
1	Slotting	슬로팅
2	Roughing	러핑
3	Finishing	마감

TECHNICAL INFORMATION FOR HP DRILLS

HP 드릴 기술 정보

ø mm	Feed Rate Code (mm per Revolution)								
	1	2	3	4	5	6	7	8	9
3	0.025	0.381	0.051	0.076	0.076	0.102	0.127	0.152	0.152
4	0.051	0.051	0.076	0.076	0.102	0.127	0.152	0.203	0.203
5	0.051	0.051	0.076	0.076	0.102	0.127	0.152	0.203	0.254
6	0.051	0.076	0.076	0.102	0.127	0.152	0.203	0.254	0.318
8	0.076	0.076	0.102	0.102	0.152	0.203	0.254	0.318	0.318
10	0.076	0.102	0.102	0.152	0.203	0.254	0.318	0.406	0.406
12	0.102	0.102	0.127	0.178	0.203	0.254	0.318	0.406	0.508
16	0.102	0.127	0.178	0.203	0.254	0.318	0.406	0.508	0.635
20	0.127	0.152	0.203	0.254	0.318	0.406	0.508	0.635	0.635

MASTERCUT TROUBLESHOOTING GUIDES

Mastercut 문제해결 가이드

Solid Carbide Endmills		
Challenge	Cause	Corrective Action
Chattering	Incorrect Feed Rate	Reduce feed rate 10%
	Incorrect Speed	Check recommendations, adjust accordingly
	Low Tool Holder Rigidity	Replace tool holder with more rigid tool holder
	Low Machine Tool Spindle Rigidity	Utilize machine with larger spindle
	Relief Angle Too Steep	Switch to tool with less relief or regrind tool to reduce angle
	Low Work Piece Rigidity	Tighten or improve work piece holding method
	Depth of Cut	Reduce depth of cut
	Incorrect Tool Cut Length	Use shorter flute length and/or place tool shank deeper in tool holder
	Bad Collet	Replace collet
	Tool Too Sharp	Reduce feed rate 10% for initial cut to break in tool
Breakage	Incorrect Feed Rate	Reduce feed rate
	Incorrect Depth of Cut	Reduce depth of cut
	Incorrect Tool Cut Length	Use shorter flute length - Place tool shank deeper in tool holder
	Incorrect Tool Overall Length	Use shorter tool or place tool shank deeper in tool holder
	Tool Wear	Replace tool or sharpen tool at earlier stage
	Chip Impaction	Increase coolant flow
Chipping	Incorrect Feed Rate	Reduce feed rate
	Improper Tool Break In	Reduce feed rate 10% for initial cut to break in tool
	Incorrect Feed Direction	Change cut path to climb milling
	Chatter	See recommendations for correcting chatter
	Low Tool Holder Rigidity	Replace tool holder with higher rigidity tool holder
	Low Machine Tool Spindle Rigidity	Utilize machine with larger spindle
	Low Work Piece Rigidity	Tighten or improve work piece holding method
	Tool Too Sharp	Reduce feed rate 10% for initial cut to break in tool
	Loose Tool Holder	Clean and tighten tool holder
	Loose End Mill	Tighten tool holder
	Incorrect Speed	Check recommendations and adjust accordingly
Lack of Hone	Hone cutting edge	
Wear	Incorrect Speed	Check recommendations and adjust accordingly
	Incorrect Feed Rate	Reduce or increase feed rate
	Incorrect Feed Direction	Change cut path to climb milling
	Hard Material	Use tool designed for hard material - Use coated tools
	Chip Impaction	Increase coolant volume - Increase coolant pressure
	Poor Coolant Condition	Replace coolant or correct mix ratio
	Short Tool Life	Use tool designed for work piece material - Use coated tools
	Incorrect Tool Geometry	Utilize tool recommended for work piece material
Chip Impaction	Incorrect Feed Rate	Reduce feed rate
	Incorrect Speed	Check recommendations and adjust accordingly
	Incorrect Tool Geometry	Utilize tool recommended for work piece material
	Insufficient Coolant	Increase coolant volume - Increase coolant pressure

MASTERCUT TROUBLESHOOTING GUIDES

Mastercut 문제해결 가이드

Solid Carbide Endmills		
Challenge	Cause	Corrective Action
Poor Surface Finish	Incorrect Feed Rate	Reduce feed rate
	Incorrect Speed	Check recommendations and adjust accordingly
	Tool Wear	Replace tool or sharpen tool at earlier stage
	Incorrect Depth of Cut	Reduce depth of cut
	Chip Impaction	Increase coolant volume - Increase coolant pressure
	End Cut Smearing	Grind tool with wiper flat
	Incorrect Tool Geometry	Utilize tool recommended for work piece material
Burring	Tool Wear	Replace tool or sharpen tool at earlier stage
	Incorrect Feed Direction	Change cut path to climb milling
	Incorrect Speed	Check recommendations and adjust accordingly
	Incorrect Feed Rate	Reduce feed rate
	Incorrect Depth of Cut	Reduce depth of cut
	Incorrect Tool Geometry	Utilize tool recommended for work piece material
Dimensional Inaccuracy	Tool Deflection	Reduce tool length of cut - Place tool deeper in tool holder
	Incorrect Tool Geometry	Utilize tool recommended for work piece material
	Low Tool Holder Rigidity	Replace tool holder with more rigid tool holder
	Low Machine Tool Spindle Rigidity	Utilize machine with larger spindle - Tighten tool holder
	Low Work Piece Rigidity	Tighten or improve work piece holding method
	Bad Collet	Replace collet
	Machine Tool/Work Piece Set Up	Check for proper angular set up

Solid Carbide Drills		
Challenge	Cause	Corrective Action
Drill Point Chipping	Incorrect Feed Rate	Lower feed rate
	Incorrect Speed Rate	Check speed recommendations, adjust accordingly
	Incorrect Tool Cut Length	Use shorter tool - place tool shank deeper in tool holder
	Low Work Piece Rigidity	Tighten or improve work piece holding method
	Loose Tool	Tighten or replace tool holding method
	Poor Coolant Conditions	Replace coolant or correct mix ratio
Chisel/Point Center Breakage	Incorrect Initial Feed Rate	Lower initial feed rate 30%
	Poor Work Piece Surface Condition	Grind or clean work piece surface
	Drill Point Off Center	Re-point drill, check set up in tool holder
	Insufficient Drill (web) Thinning	Re-point and thin drill point
Breakage/ Chipping at Outer Cutting Edge	Incorrect Feed Rate	Lower feed rate
	Incorrect Speed Rate	Check speed recommendations, adjust accordingly
	Low Work Piece Rigidity	Tighten or improve work piece holding method
	Low Tool Holding Strength	Tighten tool holder or use end mill holder
	Poor Tool Set Up - Concentricity	Minimize runout to less than .001"
	Poor Coolant Conditions	Replace coolant or correct mix ratio
	Incorrect Tool Cut Length	Use shorter tool - place tool shank deeper in tool holder
Tool Wear Life	Incorrect Speed Rate	Check speed recommendations, adjust accordingly
	Poor Coolant Conditions	Replace coolant or correct mix ratio
	Improper Drill Point	Re-point drill or use recommended drill point for material
	Abrasive/Tough Work Piece Material	Use coated tool (Check recommendations for coating)

MASTERCUT TROUBLESHOOTING GUIDES

Mastercut 문제해결 가이드

Solid Carbide Drills		
Challenge	Cause	Corrective Action
Tool Breakage	Inconsistent Feed Rate	Maintain constant feed rate
	Incorrect Feed Rate	Lower feed rate
	Poor Tool Set Up - Concentricity	Minimize runout to less than .001"
	Low Tool Holding Strength	Tighten tool holder or use end mill holder
	Incorrect Tool	Check recommendations for proper drill and drill point
	Poor Coolant Conditions	Replace coolant or correct mix ratio
	Low Work Piece Rigidity	Tighten or improve work piece holding method
Outside Margin Damage / Wear	Poor Tool Set Up - Concentricity	Minimize runout to less than .001"
	Incorrect Tool Selection	Use recommended drill/drill point for work piece material
	Poor Coolant Conditions	Replace coolant or correct mix ratio
	Insufficient Coolant	Increase coolant volume - Increase coolant pressure
	Chip Packing	Increase coolant volume - Increase coolant pressure
Outside Margin Damage / Wear (cont.)	Low Work Piece Rigidity	Tighten or improve work piece holding method
	Loose Tool	Tighten or replace tool holding method
	Incorrect Feed Rate	Lower feed rate
	Incorrect Speed Rate	Check speed recommendations adjust accordingly
Chip Impaction	Incorrect Speed Rate	Typically increase speed, check speed recommendations
	Incorrect Feed Rate	Typically increase feed recommendations
	Poor Coolant Conditions	Replace coolant or correct mix ratio
	Insufficient Coolant	Increase coolant volume - Increase coolant pressure
	Incorrect Tool	Check recommendations for proper drill and drill point
Long/Stringy Chips	Incorrect Feed Rate	Typically increase feed, check feed recommendations
	Incorrect Point Angle	Regrind Point to recommended angle, Replace drill
	Edge Sharpness	Hone cutting edge, use pre-honed drill
	Inconsistent Feed Rate	Maintain constant feed rate - Peck Drill to change feed rate
Poor Surface Finish	Incorrect Speed Rate	Typically increase speed, check speed recommendations
	Incorrect Feed Rate	Lower feed rate
	Poor Coolant Conditions	Replace coolant or correct mix ratio
	Tool Wear	Regrind or Replace drill
Hole Accuracy	Edge Sharpness	Hone cutting edge, use pre-honed drill
	Incorrect Tool	Check recommendations for proper drill and drill point
	Edge Sharpness	Hone cutting edge, use pre-honed drill
	Incorrect Tool Cut Length	Use shorter tool - place tool shank deeper in tool holder
	Tool Size Accuracy	Replace tool
Tool Deflection	Poor Work Piece Surface Condition	Grind or clean work piece surface
	Incorrect Tool Cut Length	Use shorter tool - place tool shank deeper in tool holder
	Uneven Drill Point	Regrind drill point
	Incorrect Point Angle	Regrind Point to recommended angle, Replace drill
	Uneven Work Surface	Use self centering drill point or spot drill
Vibration/Noise	Edge Sharpness	Hone cutting edge, use pre-honed drill
	Incorrect Tool Cut Length	Use shorter tool - place tool shank deeper in tool holder
	Incorrect Point Angle	Regrind Point to recommended angle, Replace drill
	Inconsistent Feed Rate	Maintain constant feed rate - Peck Drill to change feed rate
	Incorrect Speed Rate	Check speed recommendations adjust accordingly
	Low Tool Holding Strength	Tighten tool holder or use end mill holder

TROUBLESHOOTING GUIDE AND SOLUTION KEYS

문제해결 가이드 솔루션 키

Carbide Burs - Possible Causes and Solutions

Challenge Проблема	Excessive Force	Heat From Rubbing Shank	Dull Flutes	Seized In/Against Workpiece	Tool Dropped	Poor Location in Collet	Worn Handpiece Bearings	Bent Shank	Poor Working Stability	Use Coarser Geometry	Use Finer Geometry	Use Double Cut or Chip Breaker Geometry	Soft Material - Lighten Feed	Increase RPMs	Decrease RPMs	Avoid Diamond Cut	Use Anti-stick compound	Faster Feed Rate	Slower Feed	Abrasive Material	Poor Set-Up	Failure To Support / Engage Prior to RPM
Language Keys	1.	2.	3.	4.	5.	6.	7.	8.	9.	10.	11.	12.	13.	14.	15.	16.	17.	18.	19.	20.	21.	22.
A. Braze Failure	X	X	X	X	X																	
B. Poor Hand Control						X	X	X	X		X	X									X	
C. Chipping				X	X				X					X								X
D. Carbide Fracture				X	X				X													X
E. Plugging										X			X				X					
F. Handpiece Vibration														X	X		X	X			X	
G. Poor Workpiece Finish						X	X	X	X		X			X	X		X				X	
H. Poor Tool Life		X	X			X	X	X	X					X	X	X	X	X	X	X	X	X
J. Lack of Available Handpiece RPMs												X		X								
K. Work Hardening of Workpiece	X		X							X	X			X				X				
L. Bent Shanks of Long Series Burs																					X	X

A.	브레이즈 실패
B.	열악한 핸드 컨트롤
C.	치핑
D.	카바이드 균열
E.	플러깅
F.	핸드피스 진동
G.	열악한 가공물 마감
H.	열악한 공구 수명
J.	사용 가능한 핸드피스 RPM의 부족
K.	가공물의 가공 경화
L.	롱 시리즈 버의 구부러진 샹크

1.	과도한 힘
2.	마찰 샹크에서 발생하는 열
3.	무딘 플루트
4.	가공물 맞물림
5.	공구 떨어짐
6.	열악한 콜레트 위치
7.	마모된 핸드피스 베어링
8.	구부러진 샹크
9.	열악한 작업 안정성
10.	더욱 조약한 지오메트리 사용
11.	더욱 세밀한 지오메트리 사용

12.	더블 컷 또는 칩 브레이커 지오메트리 사용
13.	부드러운 소재 - 가벼운 피드
14.	RPM 증가
15.	RPM 감소
16.	다이아몬드 컷 방지
17.	안티-스틱 화합물 사용
18.	더 빠른 피드 속도
19.	더 느린 피드
20.	연마재
21.	열악한 셋업
22.	RPM 이전에 지원/참여 실패

TECHNICAL INFORMATION MATERIALS GROUPINGS

기술 정보 재료 그룹

Material Group	Material Type	Hardness	BS	EN & Other Standards
Steel				
1.1	Magnetic soft steel	< 120 B	230M07, 050A12	EN1, EN2 Leadloy
1.2	Structural, case carburising	< 200 B	060A35, 080M40, 4360-50B	EM3A, 4,6,7,8, EN207, S62
1.3	Plain carbon steel	< 250 B	080M46, 080A62	EN9, 10, 43, S70
1.4	Alloy Steel	< 250 B	708M40/42, 817M40, 534A99, BM2, BT42	"EN16,17, 19(R,S) EN31, S2-10-1-8 (Soft)"
1.5	Alloy steel, hardened/tempered steel	350	B01, BM2, BT42, 826M40, 830M32	"EN24, 25,26(T,U,V) S95, S97, S98 (annealed)"
1.6	Alloy steel, hardened/tempered steel	> 350 B	801, 826M40, 830M31	EN25, 26, 27,(W,X,Z) S97, S98, (H&T)
1.7	Alloy steel, hardened	49-55 C	B01, BD3, BH13	
1.8	Alloy steel, hardened	55-60 C	BM2, BH13	
1.9	Alloy steel, hardened	>60C		
Stainless Steel				
2.1	Free Machining Stainless	< 250 B	303 S21 416 S37	EN56, EN60
2.2	Austenetic	< 250 B	304 S15, 321 S17 316 S, 320 S12	EN80, EN58 + EN8J, 316
2.3	Ferritic + Austenetic, Martensitic	< 300 B	317 S16, 316 S16	EN58 b,e,t,j, Duplex alloys
2.4	Precipitation Hardened	< 300 B		
Cast Iron				
3.1	Lamellar graphite	< 150	grade 150, grade 400	Cast iron Soft
3.2	Lamellar graphite	>150<300	grade 200, grade 400	Cast iron Hard
3.3	Nodular graphite, malleable cast iron	< 200	420/12, P440/7 700/2, 30g/72	S.G. iron Mehanite Black & White Heart
3.4	Nodular graphite, malleable cast iron	>200<300	420/12, P440/7 700/2, 30g/72	S.G. iron Mehanite Black & White Heart
Titanium				
4.1	Unalloyed	< 200	TA1-9	Ti 99.0
4.2	Alloyed	< 270	TA10-14, TA17, TA28	Ti 2AL
4.3	Alloyed	>270<350	TA10-13, TA28	Ti AL
Nickel				
5.1	Unalloyed	< 150	NA 11, NA 12	Nickel 200, Nickel 270
5.2	Alloyed	< 270	HR203 3027-76	"Nimonic 75, Hastelloy C Monel 400, Inconel 600 Haynes Alloys 263"
5.3	Alloyed	>270<350	HR8 HR401, 601	Inconel 718, Waspalloy, Nimonic 80, Rene 41
Copper				
6.1	Copper	< 100	C101	Commercially pure
6.2	β Brass, Bronze	< 200	CZ120, CZ109, PB104	2.1030, 2.1080
6.3	γ-Brass	< 200	CZ108, CZ106	
6.4	High Strength Bronze	< 470	AB1 type	Ampco 18, Ampco 26
Aluminum, Magnesium				
7.1	Al,Mg, unalloyed	< 100	LMO, 1B, (1050A)	Magnesium Extruded Aluminium
7.2	Al alloyed, Si<0.5%	< 150	LM5, 10, 12, N4 (5251)	Low Silicon wrought & cast Aluminium
7.3	Al alloyed, Si>0.5%<10%	< 120	"LM2, 4, 16, 21, 22, 24, 25, 26,27, L109"	Silicon Alluminium
7.4	Al alloyed, Si>10%	< 120	LM6, 12, 13, 20, 28, 29, 30	Higi Silicon Alluminium
Synthetic Materials				
8.1	Thermoplastics	n/a	Polystyrene, Nylon, PVC Cellulose Acetate & Nitrate	Nylon, Hostalen Makrolon
8.2	Thermosetting plastics	n/a	Ebonite, Tufnol, Bakelite	Bakelite, Pertinax
8.3	Reinforced plastic materials	n/a	Kevlar, Printed circuit board	CFK, GFK, AFK
Hard Materials				
9.1	Cermets (Metal-ceramics)	< 550		

TECHNICAL INFORMATION FOR ENDMILLS













엔드밀 기술 정보

Suggested Endmill Starting Feed Per Tooth											
Cutting Diameter	0.4-1 mm	1-2mm	3mm	4mm	5mm	6mm	7-8mm	9-10mm	11-15mm	16-20mm	25mm
Material Group	vc m/min										
1.1	0.010	0.014	0.017	0.021	0.025	0.030	0.045	0.055	0.070	0.090	0.130
1.2	0.010	0.014	0.017	0.021	0.025	0.030	0.045	0.055	0.070	0.090	0.130
1.3	0.010	0.014	0.017	0.021	0.025	0.030	0.045	0.055	0.070	0.090	0.130
1.4	0.010	0.014	0.017	0.021	0.025	0.030	0.045	0.055	0.070	0.090	0.130
1.5	0.008	0.010	0.013	0.016	0.018	0.022	0.030	0.038	0.052	0.060	0.100
1.6	0.008	0.010	0.013	0.016	0.018	0.022	0.030	0.038	0.052	0.060	0.100
1.7	0.008	0.010	0.013	0.016	0.018	0.022	0.030	0.038	0.052	0.060	0.100
1.8	0.008	0.010	0.013	0.016	0.018	0.022	0.030	0.038	0.052	0.060	0.100
1.9											
2.1	0.008	0.010	0.013	0.016	0.018	0.022	0.030	0.038	0.052	0.075	0.100
2.2	0.008	0.010	0.013	0.016	0.018	0.022	0.030	0.038	0.052	0.075	0.100
2.3	0.008	0.010	0.013	0.016	0.018	0.022	0.030	0.038	0.052	0.075	0.100
2.4											
3.1	0.012	0.018	0.022	0.027	0.035	0.045	0.060	0.075	0.095	0.130	0.150
3.2	0.012	0.018	0.022	0.027	0.035	0.045	0.060	0.075	0.095	0.130	0.150
3.3	0.010	0.014	0.017	0.021	0.025	0.030	0.045	0.055	0.070	0.090	0.130
3.4	0.010	0.014	0.017	0.021	0.025	0.030	0.045	0.055	0.070	0.090	0.130
4.1	0.010	0.014	0.017	0.021	0.025	0.030	0.045	0.055	0.070	0.090	0.130
4.2	0.010	0.014	0.017	0.021	0.025	0.030	0.045	0.055	0.070	0.090	0.130
4.3	0.008	0.010	0.013	0.016	0.018	0.022	0.030	0.038	0.052	0.075	0.100
5.1	0.008	0.010	0.013	0.016	0.018	0.022	0.030	0.038	0.052	0.075	0.100
5.2	0.008	0.010	0.013	0.016	0.018	0.022	0.030	0.038	0.052	0.075	0.100
5.3	0.008	0.010	0.013	0.016	0.018	0.022	0.030	0.038	0.052	0.075	0.100
6.1	0.012	0.018	0.022	0.027	0.035	0.045	0.060	0.075	0.095	0.130	0.150
6.2	0.012	0.018	0.022	0.027	0.035	0.045	0.060	0.075	0.095	0.130	0.150
6.3	0.012	0.018	0.022	0.027	0.035	0.045	0.060	0.075	0.095	0.130	0.150
6.4	0.008	0.010	0.013	0.016	0.018	0.022	0.030	0.038	0.052	0.075	0.100
7.1	0.012	0.018	0.022	0.027	0.035	0.045	0.060	0.075	0.095	0.130	0.150
7.2	0.012	0.018	0.022	0.027	0.035	0.045	0.060	0.075	0.950	0.130	0.150
7.3	0.012	0.018	0.022	0.027	0.035	0.045	0.060	0.075	0.095	0.130	0.150
7.4	0.012	0.018	0.022	0.027	0.035	0.045	0.060	0.075	0.095	0.130	0.150
8.1	0.012	0.018	0.022	0.027	0.035	0.045	0.060	0.075	0.095	0.130	0.150
8.02	0.012	0.018	0.022	0.027	0.035	0.045	0.060	0.075	0.095	0.130	0.150
8.3	0.012	0.018	0.022	0.027	0.035	0.045	0.060	0.075	0.095	0.130	0.150
9.1	0.010	0.014	0.017	0.021	0.025	0.030	0.045	0.055	0.070	0.090	0.130

- Recommendations based on axial loads of $\leq 1X$ s the cutter diameter for profiling and $.5X$ s the diameter for slotting. Starting recommendations only.
- 프로파일링용 커터 직경 1X 이하 및 슬로팅용 직경 .5X의 축 하중을 기반으로 하는 권장 사항. 시작 권장 사항만.















TECHNICAL INFORMATION FOR ENDMILLS

엔드밀 기술 정보

Endmills	2 FL Standard Endmill	3 FL Standard Endmill	4 FL Standard Endmill	2 FL Standard Endmill	3 FL Standard Endmill	4 FL Standard Endmill	2 FL Long Endmill	3 FL Long Endmill	4 FL Long Endmill	2 FL Long Endmill	3 FL Long Endmill	4 FL Long Endmill
												
Series	Uncoated	Uncoated	Uncoated	PowerA	PowerA	PowerA	Uncoated	Uncoated	Uncoated	PowerA	PowerA	PowerA
	300-0,-1, 301-0,-1, 302-0,-1, 303-0,-1, 309-0,-2	300-4,-5, 301-4,-5, 302-4,-5, 303-4,-5, 310-0,-2	300-2,-3, 301-2,-3, 302-2,-3, 303-2,-3, 310-0,-2	300-0,-1, 301-0,-1, 302-0,-1, 303-0,-1, 309-0,-2	300-4,-5, 301-4,-5, 302-4,-5, 303-4,-5, 310-0,-2	300-2,-3, 301-2,-3, 302-2,-3, 303-2,-3, 310-0,-2	304-0,-2,-4,5, -6,-7	305-0,-2,-4,5, -6,-7	306-0,-2,-4,5, -6,-7	304-0,-2,-4,5, -6,-7	305-0,-2,-4,5, -6,-7	306-0,-2,-4,5, -6,-7
Material Group	vc m/min											
1.1	79-122	79-122	79-122	159-244	159-244	159-241	49-71	49-71	49-71	100-138	100-141	100-141
1.2	79-122	79-122	79-122	159-244	159-244	159-241	49-71	49-71	49-71	100-138	100-141	100-141
1.3	61-80	61-80	61-80	121-161	120-161	120-161	35-51	35-51	35-51	70-101	70-101	70-101
1.4	61-80	61-80	61-80	120-161	120-161	120-161	35-51	35-51	35-51	70-101	70-101	70-101
1.5	40-61	40-61	40-61	120-161	120-161	79-161	25-36	25-36	25-36	50-71	50-71	50-71
1.6	20-40	20-40	20-40	41-83	41-83	40-80	16-20	16-20	16-20	31-46	31-46	31-46
1.7				41-83	41-83	40-80				31-46	31-46	31-46
1.8				41-83	41-83	40-80				31-46	31-46	31-46
1.9												
2.1	40-80	40-80	40-80	79-161	79-161	79-161	25-49	25-49	25-49	49-98	49-98	49-98
2.2	31-49	31-49	31-49	61-101	61-101	61-101	20-31	20-31	20-31	40-61	40-61	40-61
2.3	25-40	25-40	25-40	49-80	49-80	49-80	16-25	16-25	16-25	31-49	31-49	31-49
2.4	22-37	22-37	22-37	46-68	46-68	46-68				25-43	25-43	25-43
3.1	49-80	49-80	49-80	100-153	100-153	100-153	35-61	35-61	35-61	70-122	70-122	70-122
3.2	40-71	40-71	40-71	79-141	79-141	79-141	31-49	31-49	31-49	61-101	61-101	61-101
3.3	35-49	35-49	35-49	70-101	70-101	70-101	25-36	25-36	25-36	49-71	49-71	49-71
3.4	25-40	25-40	25-40	49-80	49-80	49-80	20-31	20-31	20-31	40-61	41-61	41-61
4.1	61-101	61-101	61-101	121-199	121-199	121-199	35-61	35-61	35-61	70-121	70-122	70-122
4.2	40-61	40-61	40-61	79-122	79-122	79-122	25-36	25-36	25-36	49-71	50-71	50-71
4.3	20-31	20-31	20-31	40-61	40-61	40-61	16-22	16-22	16-22	31-40	31-40	31-40
5.1	61-101	61-101	61-101	121-199	121-199	121-199	35-61	35-61	35-61	70-121	70-122	70-122
5.2	31-61	31-61	31-61	61-122	61-122	61-122	20-36	20-36	20-36	40-71	40-71	40-71
5.3	20-49	20-49	20-49	40-101	40-101	40-101	16-31	16-31	16-31	31-61	31-61	31-61
6.1	100-202	100-202	100-202	197-412	197-412	197-412	61-122	61-122	61-122	121-244	197-244	197-244
6.2	129-171	129-171	129-171	257-351	257-351	257-351	100-122	100-122	100-122	200-244	197-244	197-244
6.3	129-171	129-171	129-171	257-351	257-351	257-351	100-122	100-122	100-122	200-244	197-244	197-244
6.4	22-49	22-49	22-49	50-101	50-101	50-101	20-36	20-36	20-36	40-71	41-71	41-71
7.1	151-458	151-458					100-305	100-305				
7.2	151-458	151-458					100-305	100-305				
7.3	40-80	40-80					31-61	31-61				
7.4	35-49	35-49					25-36					
8.1	79-159	79-159					61-122	61-122				
8.2	70-130	70-130					50-101	50-101				
8.3	70-130	70-130					50-101	50-101				
9.1	4-8	4-8	4-8	8-16	8-16	8-16						

SPEEDS AND FEEDS FOR MATERIAL APPLICATIONS













재료 응용 분야의 속도 및 피드

2 FL X-Long Endmill	3 FL X-Long Endmill	4 FL X-Long Endmill	2 FL X-Long Endmill	3 FL X-Long Endmill	4 FL X-Long Endmill	2 FL Square End, Minimill	2 FL Ball End, Minimill	4 FL Square End, Minimill	4 FL Ball End, Minimill	2 FL Square End, Minimill	2 FL Ball End, Minimill	4 FL Square End, Minimill	4 FL Ball End, Minimill
													
Uncoated	Uncoated	Uncoated	PowerA	PowerA	PowerA	Uncoated	Uncoated	Uncoated	Uncoated	PowerA	PowerA	PowerA	PowerA
315-0, -2, -4	316-0, -2, -4	317-0, -2, -4	315-0, -2, -4	316-0, -2, -4	317-0, -2, -4	307-1	307-0	307-5	307-4	307-1	307-0	307-5	307-4
vc m/min													
32-51	32-51	32-51	64-71	64-71	64-71	79-122	79-122	79-122	79-122	159-244	159-244	159-244	159-244
32-51	32-51	32-51	64-71	64-71	64-71	79-122	79-122	79-122	79-122	159-244	159-244	159-244	159-244
25-33	25-33	25-33	49-65	49-65	49-65	61-80	61-80	61-80	61-80	121-161	121-161	121-161	121-161
25-33	25-33	25-33	49-65	49-65	49-65	61-80	61-80	61-80	61-80	120-161	120-161	120-161	120-161
17-25	17-25	17-25	34-49	34-49	34-49	40-61	40-61	40-61	40-61	120-161	120-161	120-161	120-161
10-17	10-17	10-17	19-34	19-34	19-34	20-40	20-40	20-40	20-40	41-83	41-83	41-83	41-83
			16-33	16-33	16-33					41-83	41-83	41-83	41-83
			16-33	16-33	16-33					41-83	41-83	41-83	41-83
16-33	16-33	16-33	31-65	31-65	31-65	40-80	40-80	40-80	40-80	79-161	79-161	79-161	79-161
13-22	13-22	13-22	25-43	25-43	25-43	31-49	31-49	31-49	31-49	61-101	61-101	61-101	61-101
11-16	11-16	11-16	23-31	23-31	23-31	25-40	25-40	25-40	25-40	49-80	49-80	49-80	49-80
			20-28	20-28	20-28	22-37	22-37	22-37	22-37	46-68	46-68	46-68	46-68
20-33	20-33	20-33	40-65	40-65	40-65	49-80	49-80	49-80	49-80	100-153	100-153	100-153	100-153
16-28	16-28	16-28	31-55	31-55	31-55	40-71	40-71	40-71	40-71	79-141	79-141	79-141	79-141
14-20	14-20	14-20	28-40	28-40	28-40	35-49	35-49	35-49	35-49	70-101	70-101	70-101	70-101
10-16	10-16	10-16	19-31	19-31	19-31	25-40	25-40	25-40	25-40	49-80	49-80	49-80	49-80
25-40	25-40	25-40	49-80	49-80	49-80	61-101	61-101	61-101	61-101	121-199	121-199	121-199	121-199
17-25	17-25	17-25	34-49	34-49	34-49	40-61	40-61	40-61	40-61	79-122	79-122	79-122	79-122
8-13	8-13	8-13	16-25	16-25	16-25	20-31	20-31	20-31	20-31	40-61	40-61	40-61	40-61
25-40	25-40	25-40	49-81	49-81	49-81	61-101	61-101	61-101	61-101	121-199	121-199	121-199	121-199
13-25	13-25	13-25	25-49	25-49	25-49	31-61	31-61	31-61	31-61	61-122	61-122	61-122	61-122
10-22	10-22	10-22	16-40	16-40	16-40	20-49	20-49	20-49	20-49	40-101	40-101	40-101	40-101
40-80	40-80	40-80	80-161	80-161	80-161	100-202	100-202	100-202	100-202	197-412	197-412	197-412	197-412
52-69	52-69	52-69	103-138	103-138	103-138	129-171	129-171	129-171	129-171	257-351	257-351	257-351	257-351
52-69	52-69	52-69	16-40	16-40	16-40	129-171	129-171	129-171	129-171	257-351	257-351	257-351	257-351
10-22	10-22	10-22				22-49	22-49	22-49	22-49	50-101	50-101	50-101	50-101
61-183	61-183					151-458	151-458	151-458	151-458				
61-183	61-183					151-458	151-458	151-458	151-458				
16-33	16-33					40-80	40-80	40-80	40-80				
14-22	14-22					35-49	35-49	35-49	35-49				
32-65	32-65					79-159	79-159	79-159	79-159				
29-52	29-52					70-130	70-130	70-130	70-130				
29-52	29-52					70-130	70-130	70-130	70-130				
						4-8	4-8	4-8	4-8	8-16	8-16	8-16	8-16

TECHNICAL INFORMATION













TECHNICAL INFORMATION FOR HP ENDMILLS

HP 엔드밀 기술 정보

Endmills	V4 Stub and Standard	V4 Long	V5 Stub and Standard	V5 Long	Roughers	Roughers	HY5 Stub and Standard	HY5 Long	F45 Standard	F45 Standard	AlumaZip	TwisterMill
												
Series	PowerA	PowerA	PowerA	PowerA	Uncoated	PowerA	PowerA	PowerA	Uncoated	PowerA	Uncoated	Uncoated
	500-0,-2,-4,-5,-6,-7,-8, 502-0,-2,-4,-5,-6,-7,-8	501-0,-2,-4,-5,-6,-7,-8	508-0,-2,-4,-5,-6,-7,-8, 510-0,-2,-4,-5,-6,-7,-8	509-0,-2,-4,-5,-6,-7,-8	533-0,-1,-2	533-0,-1,-2	545-0,-2,-4,-5,-6,-7,-8, 547-0,-2,-4,-5,-6,-7,-8	546-0,-2,-4,-5,-6,-7,-8	511-0,2,3,4,5	511-0,2,3,4,5	530-0,2,4,5,6	532-0
Material Group	vc m/min											
1.1	151-244	100-138	151-244	100-138	79-121	151-214	151-427	99-275				
1.2	151-244	100-138	151-244	100-138	79-121	151-214	151-427	99-275				
1.3	121-161	68-101	121-161	68-101	61-80	121-168	100-305	67-199				
1.4	121-161	68-101	121-161	68-101	61-80	121-168	100-305	67-199	67-199	100-305		
1.5	76-122	50-69	100-214	50-69	40-61	76-122	100-199	67-130	67-130	100-199		
1.6	40-77	31-51	100-214	31-51	20-40	38-80	100-199	67-130	67-130	100-199		
1.7	40-77	31-51	100-214	31-51			100-199	67-130	67-130	100-199		
1.8	40-77	31-51	100-214	31-51			100-199	67-130	67-130	100-199		
1.9												
2.1	76-244	50-101	76-244	50-101	40-80	76-168	76-244	49-159	49-159	76-244		50-101
2.2	61-183	38-61	61-183	38-61	31-49	61-100	61-183	40-122	40-122	61-183		41-61
2.3	50-92	31-51	50-92	31-51	25-40	49-80	31-92	20-61	20-61	31-92		25-55
2.4	44-61	34-49	44-61	34-49								
3.1	64-214	68-122	64-214	68-122	49-80	97-168	61-199	40-130				
3.2	55-168	61-101	55-168	61-101	40-71	79-138	50-176	31-116				
3.3	46-138	50-69	46-138	50-69	35-49	70-100	41-141	28-92				
3.4	34-101	38-61	34-101	38-61	25-40	49-80	31-92	20-61				
4.1	61-122	61-101	100-305	61-101	61-101	121-199	100-305	67-199	67-199	100-305		79-130
4.2	38-101	50-69	76-244	50-69	40-61	79-122	79-244	40-159	40-159	79-244		50-80
4.3	40-61	31-39	40-122	31-39	20-31	40-61	40-122	26-80	26-80	40-122		25-42
5.1	100-214	68-122	100-305	68-122	61-101	121-199	100-305	67-199	67-199	100-305		79-130
5.2	76-244	38-69	76-244	38-69	31-61	91-122	79-244	52-159	52-159	79-244		40-80
5.3	40-122	31-61	40-122	31-61	20-49	40-100	40-122	26-80	26-80	40-122		25-71
6.1					100-202							
6.2					129-171							197-260
6.3					129-171							197-260
6.4					20-49							41-80
7.1					49-458					363-915		
7.2					61-458					363-915		
7.3					40-80					302-762		
7.4					35-49					100-458		
8.1					79-159					197-610		
8.2					70-130					91-275		
8.3					70-130							
9.1												

SPEEDS AND FEEDS FOR MATERIAL APPLICATIONS

재료 응용 분야의 속도 및 피드

HyperMill	Mold Mills Standard Length	Mold Mills Standard Length	Mold Mills Standard Length	Mold Mills Long Length	Mold Mills Long Length	Mold Mills Long Length	AxMill 2 Flute Standard Length	AxMill 2 Flute Long Length	AxMill 2 Flute Stub Length	AxMill 3 Flute Standard Length	AxMill 3 Flute Long Length	AxMill 3 Flute Stub Length
												
Uncoated	Uncoated	PowerA	PowerN	Uncoated	PowerA	PowerN	Uncoated	Uncoated	Uncoated	Uncoated	Uncoated	Uncoated
528-0	540-4, -6, -8, 541-0, -2, 542-0, -1	540-4, -6, -8, 541-0, -2, 542-0, -1	540-4, -6, -8, 541-0, -2, 542-0, -1	537-0, -4, 542-2, -3, 543-1	537-0, -4, 542-2, -3, 543-1	537-0, 542-2, 543-1	514-0, -2, -4, -5, -6, -7, -8	515-0, -2, -4, -5, -6, -7	516-0, -2, -4, -5, -6, -7, -8	520-0, -2, -4, -5, -6, -7, -8	521-0, -2, -4, -5, -6, -7, -8	522-0, -2, -4, -5, -6, -7, -8
vc m/min												
	50-71	100-141	139-199	31-43	61-84	85-119						
	50-71	100-141	139-199	31-43	61-84	85-119						
	35-51	70-101	99-141	22-31	43-61	61-86						
	35-51	70-101	99-141	22-31	43-61	61-86						
	26-36	50-71	70-100	16-22	31-43	43-61						
	16-31	31-61	43-86	13-23	19-37	26-52						
	16-31	31-61	43-86	13-23	19-37	26-52						
	16-31	31-61	43-86	13-23	19-37	26-52						
	16-31	40-77	43-86									
	26-51	50-101	70-141	19-37	31-61	43-86						
	22-31	41-61	58-86	16-23	25-37	35-52						
	16-26	31-51	43-71	13-22	19-31	26-43						
	26-46	50-92	70-141	19-34	31-55	43-77						
	31-51	61-101	85-141	23-37	37-61	52-86						
	26-36	50-71	58-86	19-26	31-43	43-61						
	22-31	41-61	58-86	16-23	25-37	35-52						
	35-61	70-122	99-171	22-45	43-74	61-104						
	26-36	50-71	70-100	19-26	31-43	43-61						
	16-22	31-42	43-58	13-16	19-25	26-36						
	35-61	70-122	99-171	22-45	43-74	61-104						
	22-36	41-71	58-100	16-22	25-43	35-61						
	16-31	31-61	43-86	13-23	19-37	26-52						
	61-122	121-244	170-336	44-89	73-147	103-205						
	99-122	197-244	272-336	71-89	118-147	166-206	242-305	242-305	242-305	242-305	242-305	242-305
	99-122	197-244	272-336	71-89	118-147	166-206	182-275	182-275	182-275	182-275	182-275	182-275
	22-36	41-71	58-100	16-22	25-43	35-61	129-171	129-171	129-171	129-171	129-171	129-171
							20-49	20-49	20-49	20-49	20-49	20-49
363-915							363-762	363-762	363-762	363-762	363-762	363-762
363-915							182-366	182-366	182-366	182-366	182-366	182-366
302-762							151-244	151-244	151-244	151-244	151-244	151-244
100-458							91-183	91-183	91-183	91-183	91-183	91-183
197-610							197-610	197-610	197-610	197-610	197-610	197-610
91-275							91-275	91-275	91-275	91-275	91-275	91-275
							70-130	70-130	70-130	70-130	70-130	70-130

Terms and Conditions - 이용 약관

To Order

Faxed or e-mailed orders are required. Please specify quantity and EDP/Part numbers.

Minimum Orders: \$50 for standard items, \$200 for special orders. Orders below \$50 are subject to a \$7.50 handling fee.

Standard Payment Terms

Overseas customers: Prepaid.

US customers: Net 30 Days, pending credit approval, past due after 30 days from billing date.

Freight

International orders are shipped under the Incoterm ExWorks. Mastercut Tool Corp. offers daily service with FedEx and UPS. Shipments made Pre-Pay & Add on Mastercut's FedEx or UPS accounts are subject to a \$2.50 handling fee for domestic shipments and a \$25.00 handling fee for international shipments. We are also happy to utilize any freight carrier when shipping on a collect or third-party account, with no additional handling fee.

Return Policy

We do not accept returns on items which we do not maintain in stock. Returns are subject to a 25% re-stocking fee. No returns on specials. No returns will be accepted beyond 2 months from date of shipment.

Additional Offerings

Special Tooling for your requirements.

When you need a non-standard tool for a specific job, give us a call. Requirements for special tooling or modifications of existing standard items will be given prompt, expert attention.

주문

팩스 또는 이메일로 주문해야 합니다. 수량 및 EDP/부품 번호를 지정하십시오.

최소 주문: 표준 품목의 경우 \$50, 특별 주문의 경우 \$200. \$50 이하 주문에는 \$7.50의 수수료가 부과됩니다.

표준 결제 조건

해외 고객: 선불.

미국 고객: 30일, 보류중인 크레딧 승인, 청구 날짜로부터 30일 기한 경과 후.

화물

국제 주문은 Incoterm ExWorks에 따라 배송됩니다. Mastercut Tool Corp.은 FedEx 및 UPS와 함께 매일 서비스를 제공합니다. Mastercut의 FedEx 또는 UPS 계정에서 선불로 결제되고 추가된 발송물은 국내 발송물에 대해 \$2.50의 수수료가 부과되며 국제 발송물에 대해 \$25.00의 수수료가 부과됩니다. 수신자 부담 또는 제3자 계정으로 배송 시 추가 처리 수수료가 없이 모든 화물 운송 업체를 이용할 수 있습니다.

반품 정책

재고가 유지되지 않는 품목에 대해서는 반품을 받지 않습니다. 반품에는 25%의 재입고 수수료가 부과됩니다. 특별 행사의 경우 반품 없음. 배송일로부터 2개월 이후에는 반품이 불가능합니다.

추가 오퍼링

귀하의 요구사항에 맞는 특수 공구.

특정 업무에 비표준 도구가 필요할 경우 전화하십시오. 특수 공구 또는 기존 표준 품목의 변경 요구는 전문가가 신속하게 처리합니다.



Please contact us for our full line of fractional products

당사의 전체 프랙셔널 제품군은 저희에게 문의하십시오.



Metric catalog available in the following languages:

다음 추가 언어로 메트릭 카탈로그 사용 가능:

Chinese
English
French
German
Italian

Japanese
Korean
Portuguese
Russian
Spanish



SOLID CARBIDE ENDMILLS
솔리드 카바이드 엔드밀



HIGH PERFORMANCE ENDMILLS
고성능 엔드밀

PRO+ PERFORMANCE
초고성능



ROUTERS FOR WOOD, PLASTIC, AND FIBERGLASS
목재, 플라스틱 및 유리섬유의 라우터

DRILLS, COUNTERSINKS
드릴, 카운터싱크

REAMERS
리머



CARBIDE BURS
카바이드 버



105

Mastercut Tool Corp. - Corporate Headquarters
965 Harbor Lake Dr.
Safety Harbor, Florida 34695 USA
Tel: (727) 726-5336
Fax: (727) 725-2532

Mastercut Tool Corp. - European Warehouse
Heliumstraat 8
7463PL Rijssen
Netherlands
Tel: +31 404 002839

Email: sales@mastercuttool.com
Web: www.mastercuttool.com



Proudly Distributed By:

